



AltaView[™] Software User's Manual



Part Number: 14601-00000-M3
Cage Code: 4RK27 • NAICS: 334210 • UEID: LNNKMC7W4VM5

4901 Rockaway Blvd, Building A
Rio Rancho, NM 87124 USA
(tel) 505-994-3111 • www.altadt.com

CUSTOMER NOTES:

Document Information:

Rev M3 – Release Date:

July 1, 2024

Note to the Reader and End-User:

This document is provided for information only and is copyrighted by Alta Data Technologies. While Alta strives to provide the most accurate information, there may be errors and omissions in this document. Alta disclaims all liability in document errors and any product usage. By using an Alta product, the customer or end user agrees (1) to accept Alta's Standard Terms and Conditions of Sale, Standard Warranty and Software License and (2) to not hold Alta Members, Employees, Contractors or Sales & Support Representatives responsible for any loss or legal liability, tangible or intangible, from any document errors or any product usage.

The product described in this document is not US ITAR controlled. Use of Alta products or documentation in violation of local usage, waste discard and export control rules, or in violation of US ITAR regulations, voids product warranty and shall not be supported. This document may be distributed to support government programs and projects. Third party person, company or consultant distribution is not allowed without Alta's written permission.

AltaCore, AltaCore-1553, AltaCore-ARINC, AltaAPI, AltaAPI-LV, AltaView, AltaRTVal, ENET-1553, ENET-A429, ENET-1553-EBR, NLINE-E1553, NLINE-T1553, NLINE-U1553, NLINE-EA429, NLINE-UA429, MEZ-E1553 and USB-MA4 are Trademarks of Alta Data Technologies LLC, Rio Rancho, New Mexico USA

Contact:

We welcome comments and suggestions. Please contact us at 888-429-1553 (toll free in US) or 505-994-3111 or visit our web site for support submit forms at www.altadt.com.

Table of Contents

Chapter 0 – System Configuration	1
Windows Power Settings	1
Alta Device Hardware Configuration and <i>AltaView</i> Enabled Features.....	1
Managing <i>AltaView</i> Files	1
Chapter 1 – The Top-Level Window.....	2
Splash Page and the Default Configuration File	3
Logo Button Selections.....	4
Open Device	4
Opening ENET/NLINE-E/MEZ-E Devices.....	6
Load Configuration.....	9
Save Configuration.....	9
Save As Default Configuration	9
Reset Default Configuration	10
Convert Device.....	10
Close All Devices	11
Exit.....	12
The Quick-Access Toolbar (QAT).....	13
Top-Level Buttons.....	14
Managing Devices	15
ENET, NLINE-E and MEZ-E Devices	17
<i>AltaView</i> Time Stamps – Date/Time Format.....	20
Software Versions Before 2.6.5.2.....	20
Software Versions 2.6.5.2 and Later	21
Managing <i>AltaView</i> Windows	24
Chapter 2 – Global Tools	25
Localization Tools.....	25
Board-Level Tools.....	25
Board-Global Control	26
Clock Options	26

IRIG Time Input	28
Temperature	30
1553 Output Voltage.....	31
A429 Output Voltage	32
Program FLASH.....	33
ENET Tools	38
ENET Config.....	38
RT/SA Filters.....	42
UDP/APMP Send Interval.....	43
Label Filters	44
1553 BM APMP.....	45
A429 RX APMP.....	48
Chapter 3 – MIL-STD-1553 Tools	51
EBR1553 Operation.....	51
General Tools	51
1553 Options.....	52
User Names	53
Time Options.....	54
Bus Monitor Tools.....	55
BM Control	55
1553 BM Error Codes	56
BM Linked File Viewer.....	57
BM Discovery Tree	59
Control Tab.....	60
Statistics Tab	83
Frames Tab.....	85
Filters Tab.....	85
Triggers Tab.....	86
Start BM	90
Stop BM	90
File Viewer	90

Find Timestamp.....	92
Signal Viewer	93
Test Signal Tab	96
Trigger Setup.....	98
Data Table	101
Remote Terminal Tools	107
RT Control.....	107
Start RTs.....	117
Stop RTs	117
Bus Controller Tools	118
BC Control Panel	118
BC Control Panel – Basic BC – Top Level	120
BC Control Panel – Basic BC – Message Level.....	122
BC Control Panel – Basic BC – Buffer Level.....	125
BC Control Panel – Basic BC – Bus Controller List.....	128
BC Control Panel – Aperiodic Msgs – Top Level.....	130
BC Control Panel – Aperiodic Msgs – Aperiodic List Level	131
BC Control Panel – Aperiodic Msgs – Message Level	133
BC Control Panel – Aperiodic Msgs – Buffer Level.....	134
Start BC	135
Stop BC.....	135
Playback Tools	136
Playback Control	136
Start PB.....	139
Stop PB.....	139
Synchronous Playback.....	139
Chapter 4 – ARINC-429 Tools	143
Configuration Tools.....	143
EQID/Label Editor	143
Channel Settings.....	153
Receive Tools	154

RX Control	154
RX Linked File Viewer	155
RX Discovery Tree	156
Control Tab.....	156
Statistics Tab	164
Filters Tab.....	165
Triggers Tab.....	166
Start RX	168
Stop RX.....	168
File Viewer	168
Find Timestamp.....	169
Signal Viewer	171
Data Table	175
Transmit Tools.....	177
TX Control.....	177
TX Control Panel – Top Level	178
TX Control Panel – TX Channel Level	179
TX Control Panel – Label Level	182
TX Control Panel – Field Level.....	183
Playback Tools	185
Enabling Playback.....	185
Playback Control	186
Synchronous Playback.....	190
Chapter 5 – WMUX Tools	193
General Tools	193
Time Options.....	193
Bus Monitor Tools.....	194
BM Control	194
WMUX BM Error Codes.....	195
BM Discovery Tree	196
Control Tab.....	197

Start BM	207
Stop BM	207
File Viewer	207
RIU Tools.....	208
RIU Control	208
Start RIUs	213
Stop RIUs.....	213
CIU Tools.....	214
CIU Control Panel	214
CIU Control Panel – Basic CIU – Top Level	216
CIU Control Panel – Basic CIU – Frame Level	217
CIU Control Panel – Basic CIU – Message Level	218
CIU Control Panel – Basic CIU – Buffer Level	219
Start CIU	221
Stop CIU	221
Appendix A – System Requirements.....	222
Appendix B – XML Configuration Files.....	223
1553 Configuration File.....	224
1553 Data Table	229
A429 Configuration File	230
Appendix C – File Formats.....	231
1553 BM Data (CDP Files)	231
A429 RX Data (RXP Files)	233
WMUX BM Data (CWP Files)	234
Appendix D – Remote Operation	236
Running the Alta Server.....	236
Running the <i>AltaView</i> Client	237
Appendix E – Enabled Features - 1553.....	239
Appendix F – Enabled Features – ARINC-429.....	240
Appendix G – Enabled Features – WMUX.....	241
Appendix H – Enabled Features – ENET-1553-EBR	242

Appendix I – Alta ENET UDP Protocols	243
1. SCOPE	243
2. REFERENCES.....	243
3. ALTA DEVICE CONTROL PROTOCOL (ADCP)	243
3.1 General Description	243
3.2 UDP Port Numbers.....	244
3.3 Basic Operations	244
3.4 Error Detection and Error Handling	244
3.5 ADCP Packet Format	245
4. ALTA PASSIVE MONITOR PROTOCOL (APMP)	247
4.1 General Description.....	247
4.2 UDP Port Numbers.....	247
4.3 Basic Operations	247
4.4 Error Detection and Error Handling	248
4.5 APMP Packet Format	249
Manual Revision Information	250

Chapter 0 – System Configuration

Windows Power Settings

If Windows goes into “sleep” mode to save power this will stop communication with the Alta device and will be a problem for any software using the device. Go to the Windows Control Panel, System and Security, Power Options. For your power plan, select “Change Plan Settings”. There are three settings – “Dim the display”, “Turn off the display”, and “Put the computer to sleep”. **Select “Never” for “Put the computer to sleep”.**

Alta Device Hardware Configuration and *AltaView* Enabled Features

The *AltaView* software enables or disables features based on the hardware configuration of the selected Alta device. For example, if you have a dual-function 1553 device the software allows the device to be opened in either RT mode with BM capability or BC mode with BM. **See Appendix E through Appendix G for details on enabled features by hardware configuration.**

Managing *AltaView* Files

Beginning with release v3.1.0.1, when *AltaView* is started the first time after installation the following folder will be created (where <login name> is the username used to login to the current session):

```
C:\Users\<login name>\Documents\AltaView Files
```

The default configuration file for *AltaView* (AV_Default.xml) will then be stored in this folder. Thus, it is no longer necessary to have Admin privileges to update the default configuration, as was the case with previous versions of *AltaView*. (See section ‘Splash Page and the Default Configuration File’ for additional information.)

We recommend also using this folder to store other *AltaView* saved configuration files, bus monitor archive files, etc.

Chapter 1 – The Top-Level Window

When you first run *AltaView*, you will start at the top-level window:

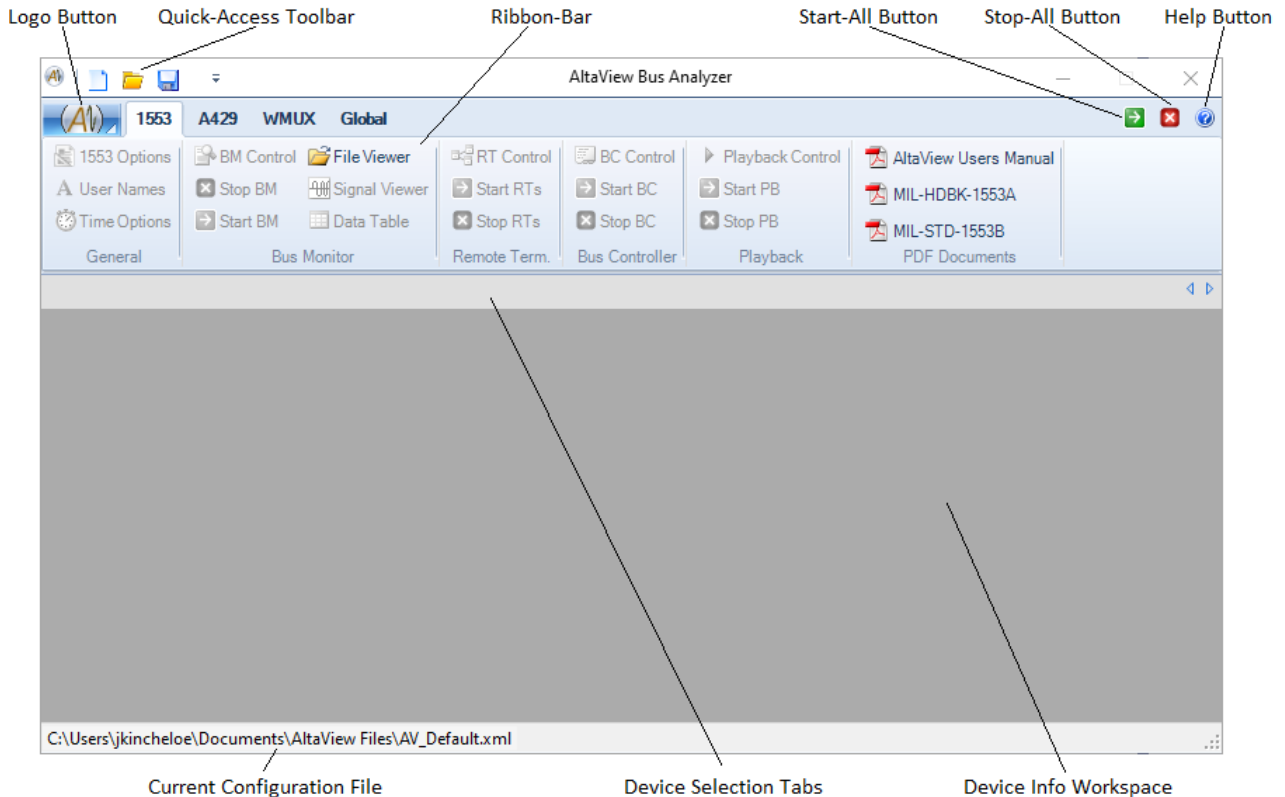

AltaView uses the **Microsoft Office 2007™** user interface style. The “Logo Button” replaces the old-style File Menu – it provides a pull-down menu with selections to open devices, load/save files, etc. The “Quick Access Toolbar” (QAT) can be customized by the user to show buttons at the top-level for the desired tools from the ribbon-bar. The “Ribbon-Bar” organizes tools under tab selections by protocol/category. The “Start-All Button” will start all devices that are open under *AltaView*. The “Stop-All Button” will stop all devices that are open under *AltaView*. The “Help Button” will display the version of the *AltaView* software. The “Device Selection Tabs” will display a tab for each device open under *AltaView*. The controls on the ribbon-bar will operate on the device associated with the selected tab. The “Device Info Workspace” will display basic information on each device open under *AltaView*.

Splash Page and the Default Configuration File

When you first start **AltaView** a splash page is displayed.

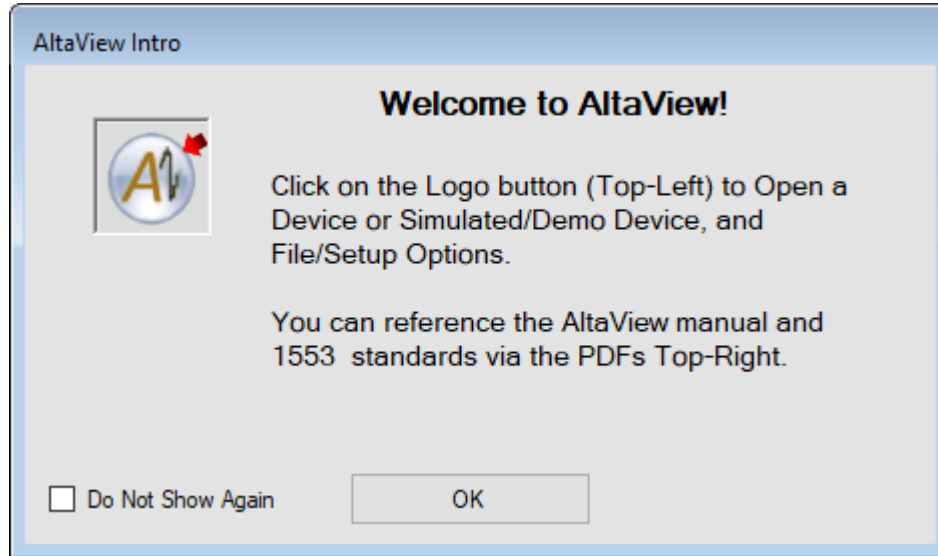

If you no longer want the splash page to be shown on startup you can check the box for “Do Not Show Again”. This will save the default XML configuration file to disable the splash page display.

The default configuration file for **AltaView** is “AV_Default.xml”. Beginning with **AltaView** version v3.1.0.1 this file resides in the folder below (where <login name> is the username used to login to the current session):

```
C:\Users\<login name>\Documents\AltaView Files
```

Each time **AltaView** is opened under another username after installation of this software release, the default configuration file will be loaded from the folder above. If the AV_Default.xml file is not found, then the AV_Default.xml delivered with the release will be copied to the folder above. This folder is not removed during an uninstall of the Alta software, therefore preserving each user’s own copy of AV_Default.xml after updating to a newer release of **AltaView**.

Logo Button Selections

The Logo Button provides options to open a device, load and save XML configuration files, save a default XML configuration file, close all devices, and exit the software.

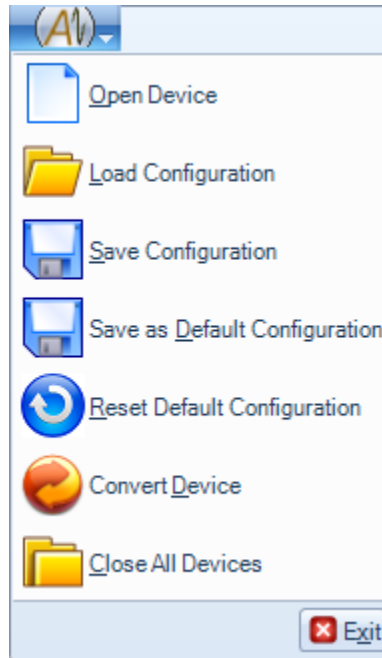

Open Device

The “Open Device” button opens a new Alta device for operation under *AltaView*. When this button is selected you will see the “Open Alta Device” dialog box:

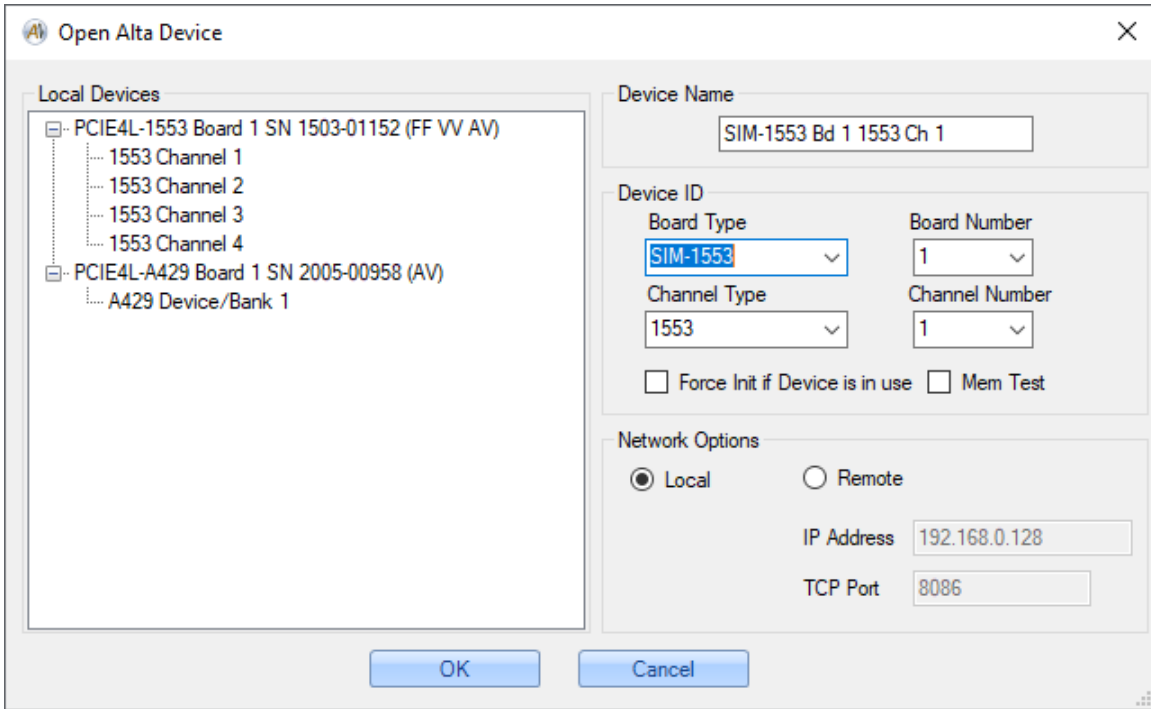

This dialog-box displays a tree-view showing the Alta devices detected in the local system. (ENET devices are not displayed in the tree. Refer to section ‘Opening ENET/NLINE-E/MEZ-E Devices’ for instructions on opening ENET devices.) Each Alta board in the tree includes the board serial number and information on the capabilities enabled for the board. The serial number is displayed as a four-digit date code (YYMM) followed by a five-digit sequence number. The capabilities are displayed in parenthesis following the serial number. The following table lists the possible capability codes and their meanings:

Capability Code	Description
SF	Single-Function
DF	Dual-Function
FF	Full-Function
VV	Has Variable Voltage option
RTV	Enabled for use with AltaRTVal
AV	Enabled with full AltaView capabilities
WP	Write Protect (-N option) (cannot program non-volatile memory)

You can select the desired device by clicking on a node in the tree or by selecting the desired options in the “Device ID” combo-boxes. The top-level

node for each board is the “Global” device for the board. A channel-level device node is provided for each available channel on the board.

The “Device Name” is a text string assigned by the user to identify the device. This defaults to a string containing the board type, board number, channel type, and channel number. If desired, you can edit the device name to be anything you want.

If a device was not closed properly you may get a “device in use” error when you try to open it again. You can check the “Force Init if Device is in use” box to override this error.

If you check the box for “Mem Test” then the software will perform a full memory test on the device as part of initialization. This test can take several seconds to complete.

If a NON-ENET device is to be controlled remotely over the network (using .NET Remoting), you can select “Remote” under Network Options and provide the IP Address of the remote system and the TCP port number being used by the server (the server application MUST be running on the remote system).

Opening ENET/NLINE-E/MEZ-E Devices

ENET (NLINE-E and MEZ-E devices are included in references to ENET devices) devices will not appear in the “Local Devices” tree (because they are remote devices on the network). However, you can select an ENET device type from the “Board Type” combo-box in the “Device ID” panel.

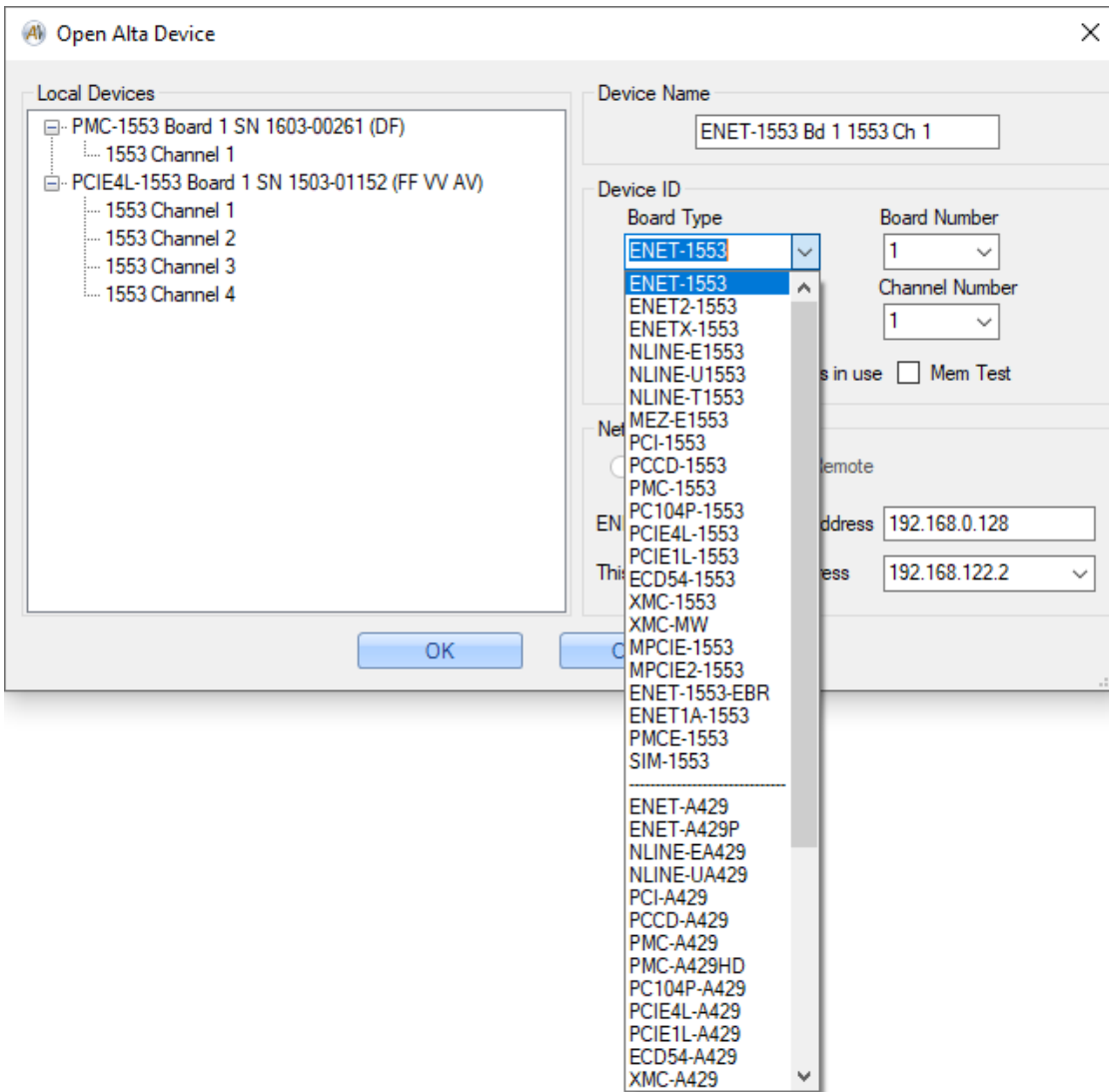

If an ENET Board Type is selected, the format of the “Network Options” panel changes.

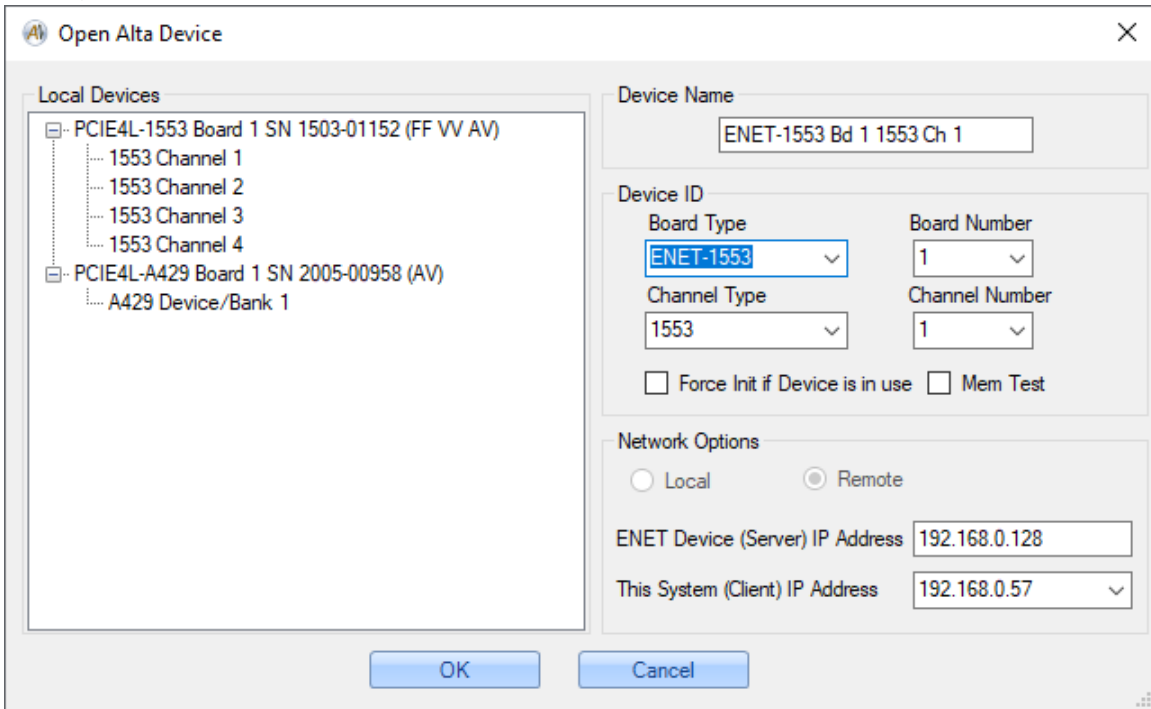

The “Local” and “Remote” radio buttons are disabled – forced to “Remote”. A text box is provided for the IP Address of the ENET Device (Server). A combo-box is provided for the IP Address of the system (Client) – this is populated with the valid IP Addresses detected for network interfaces in the system. If there is only one network interface then only one IP address will be listed. If the system has multiple active network interfaces then an IP address will be listed for each. You can use the Windows Console command “ipconfig” to view the network interfaces and IP addresses in your system.

If you enter the wrong IP address for the ENET device, the API will not be able to communicate with the device and an error will be displayed.

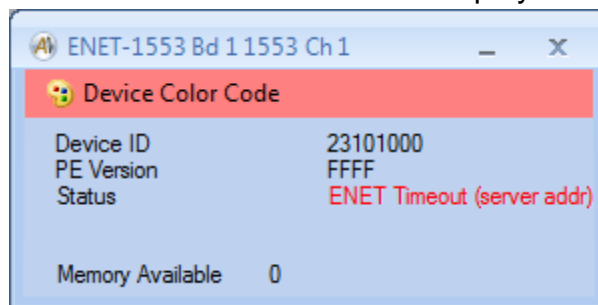

If the ENET device is found then the device will be opened successfully.

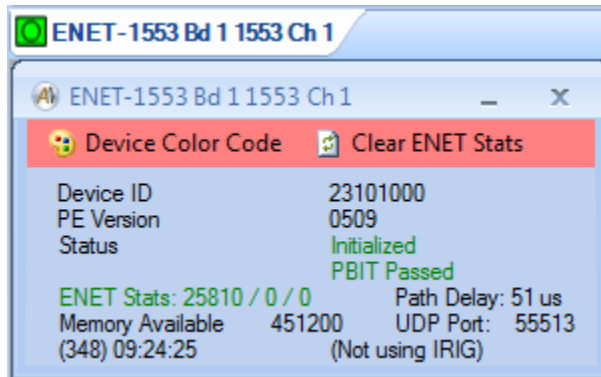

The Device Info form for the ENET device is explained in the section on 'ENET, NLINE-E and MEZ-E Devices'.

Load Configuration

The "Load Configuration" button is used to load a saved XML configuration file. This button will bring up an open-file dialog box. Select the desired XML configuration file with this dialog box. *AltaView* will validate the XML configuration file against the schema defined in "AV_Configuration.xsd" and will pop-up a message box if any errors were found during validation.

Save Configuration

The "Save Configuration" button is used to save the current configuration as an XML configuration file. This button will bring up a save-file dialog box. Use this dialog box to assign a file name and path to save the file.

Save As Default Configuration

The "Save As Default Configuration" button will save the current configuration as "AV_Default.xml". The software will load this configuration file on start-up.

NOTE: The XML configuration file format provides an option to run the 1553 Bus Monitor automatically on start-up. This is defined by the element M1553_BM_InitAction2.

```
<M1553_BM_InitAction2 Run="false" />
```

When you save an XML configuration file the "Run" attribute will be set to "false". If you edit the file and change this to "true" then *AltaView* will open a BM Control Panel window for the device and start the BM when the file is loaded.

NOTE: The XML configuration file format provides an option to run the A429 Receive automatically on start-up. This is defined by the element A429_RX_InitAction.

```
<A429_RX_InitAction Run="false" />
```

When you save an XML configuration file the “Run” attribute will be set to “false”. If you edit the file and change this to “true” then **AltaView** will open a RX Control Panel window for the device and start the RX when the file is loaded.

The XML configuration file format is discussed further in Appendix B – XML Configuration Files.

Reset Default Configuration

The “Reset Default Configuration” button sets the default configuration file back to its original state from when the software was first installed.

Convert Device

The “Convert Device” selection allows the user to open an existing AltaView configuration XML file and change the devices saved in it and then save the configuration XML to another file.

When clicked an open file dialog will appear prompting the user to select an AltaView configuration XML file.

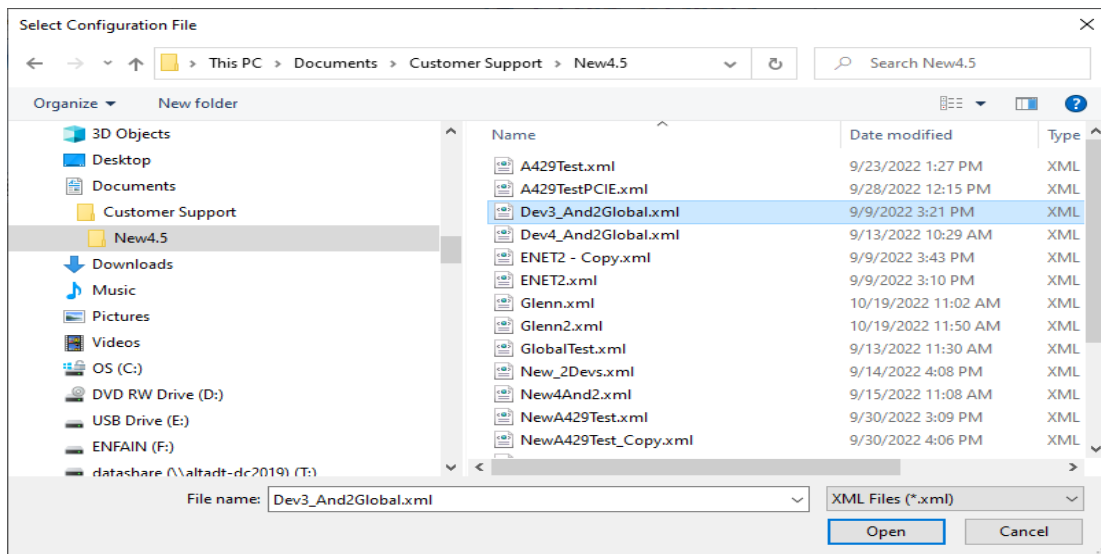

When the user opens an AltaView configuration XML file a dialog a “Convert Configured Devices” dialog will appear, which has a similar layout to the “Open Alta Device” dialog.

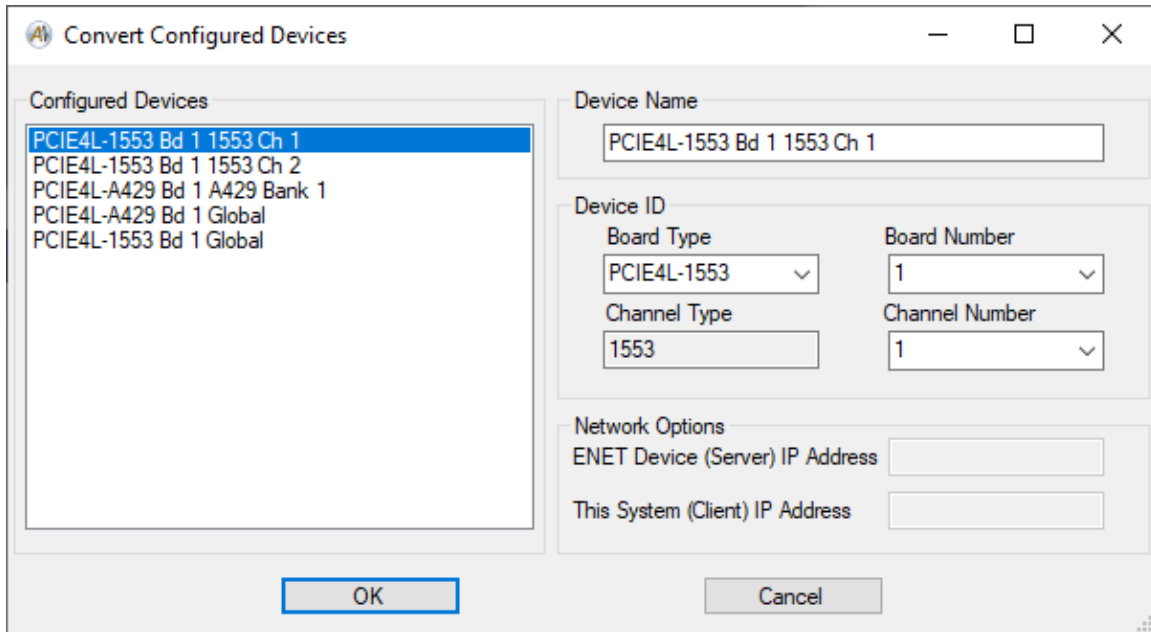

The “Configured Devices” list box on the left side of the dialog will populate with the devices from the configuration file. The user may then select the devices and change the Device Name, Board Type, Board Number and Channel Number. Note that the Channel Type is displayed but the user cannot change the Channel Type. Also if the Board Type is an ethernet connected device (ENET, NLINE-E, etc) then the “Network” group box will be enabled and the user can change the ENET Device and/or the System IP Addresses.

When a device is changed it will be updated in the Configured Devices list. Any number of the listed devices may be changed. Once complete the user should click the “OK” button. Afterwards a Save File dialog will appear to allow the user to save the newly configured file with the selected devices.

Close All Devices

The “Close All Devices” button closes all devices that are currently open under *AltaView*. This returns *AltaView* to a “blank” start-up state.

Exit

The “Exit” button will close and exit the *AltaView* software after prompting the user to save the current configuration.

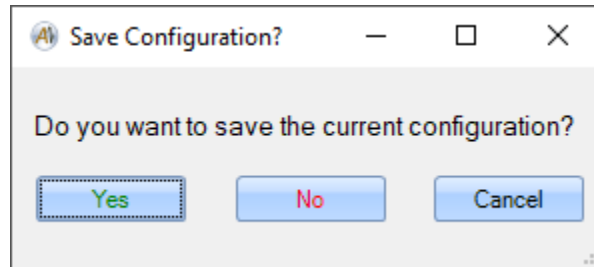

The Quick-Access Toolbar (QAT)

The QAT provides a means of placing commonly used tools on a top-level toolbar. Note that using the QAT is optional – only use it if desired. Use the pull-down item to the right of the logo button to access the QAT menu:

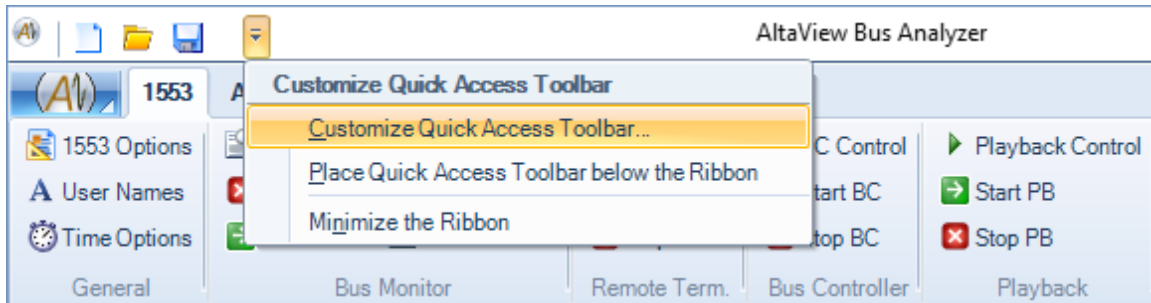

This allows you to customize the QAT, place it below the ribbon-bar (rather than in the default position above the ribbon bar), and to minimize the ribbon-bar. If you select “Customize Quick Access Toolbar...” you will see the following dialog box:

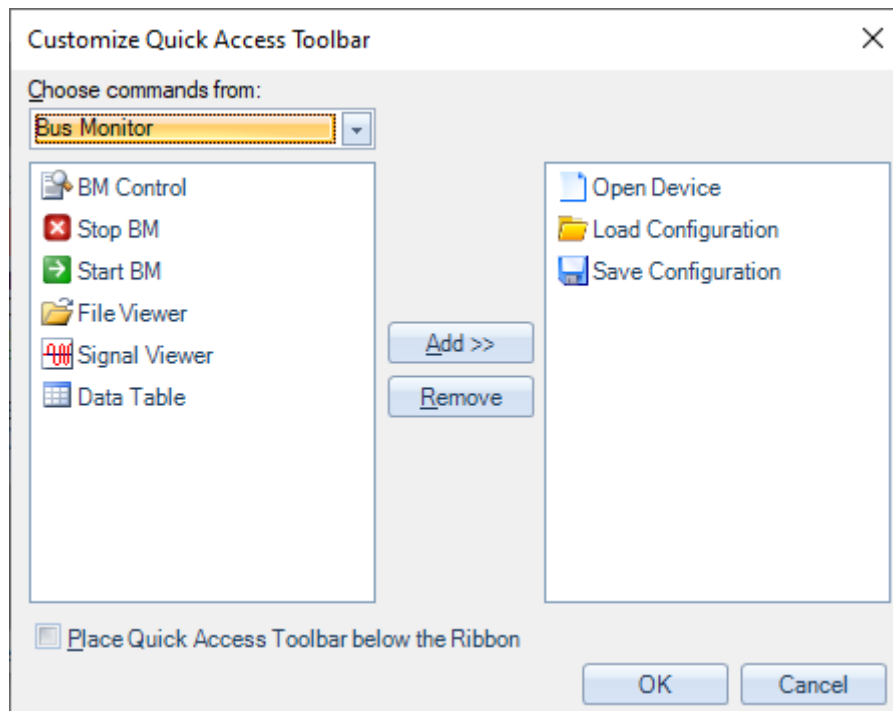

The combo-box labeled “Choose commands from” selects the tool category from the ribbon-bar. Any tools in that category are shown for selection. Select the

desired tools and use the “Add” and “Remove” buttons to configure the QAT. Select “OK” when done.

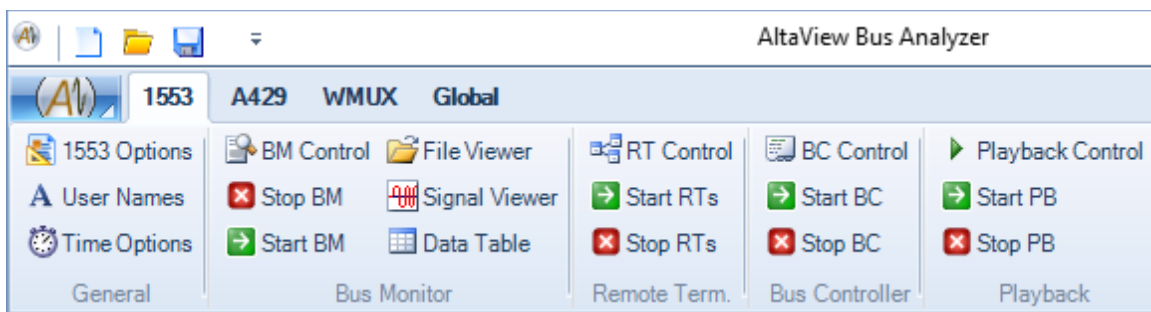

Now you will see the selected controls on the Quick-Access Toolbar to the right of the logo button.

Top-Level Buttons

AltaView provides three top-level buttons that are always available – Start All, Stop All, and Help. These are located on the upper-right area of the window:



The Start All and Stop All buttons are used to start or stop all devices currently open under *AltaView* – this is useful when controlling multiple devices/channels that need to operate simultaneously.

The Start All button starts devices in the order they were opened. For 1553 devices, the BM is started first then RT is started then BC is started. For A429 devices the RX is started first then TX is started. For WMUX devices, the BM is started first then RIU is started then CIU is started.

The Help button provides basic *AltaView* version information.

Managing Devices

When a device is opened (either by opening a new device or by loading a saved configuration file), a tab will be added to the Device Selection tab-bar and a device information window will be displayed in the Device Info Workspace.

The device tab contains a circle-square icon (bus activity icon) and the name of the device. For board-global devices the activity icon is updated by the Board Global Control Panel (if this form is open) and represents the IRIG time signal lock status (green for locked, red for not locked) – refer to the section on the Global Control Panel for details on this. For 1553 devices the activity icon is updated by the 1553 BM Control Panel (if this form is open) and represents the 1553 bus activity – refer to the section on the 1553 BM Control Panel for details. For A429 devices the activity icon is updated by the A429 RX Control Panel (if this form is open) and represents the A429 bus activity – refer to the section on the A429 RX Control Panel for details.

The device information window shows the device ID, PE (firmware) version, device status, the amount of user memory (in bytes) available, and the time value for the device. By default the device will use an internal counter for time and **AltaView** will initialize this counter to match PC time. If you configure the device to use IRIG time then the IRIG lock status will be displayed in place of “(Not using IRIG)”.

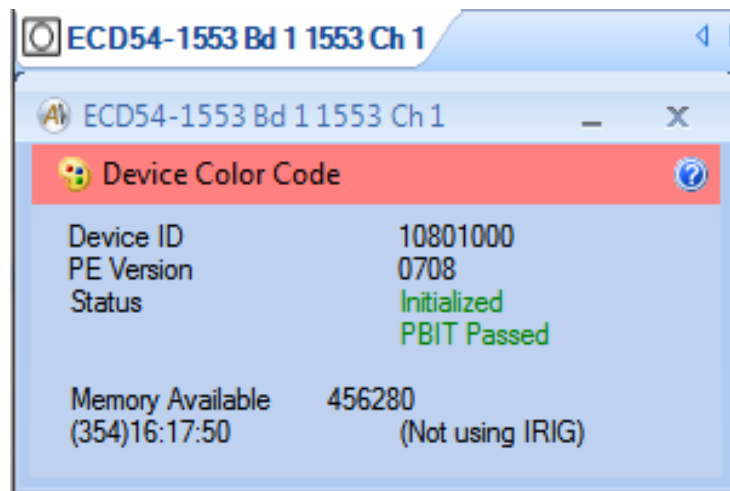

If you double-click on a device information window a message box will display the Layer 0 and Layer 1 API versions.

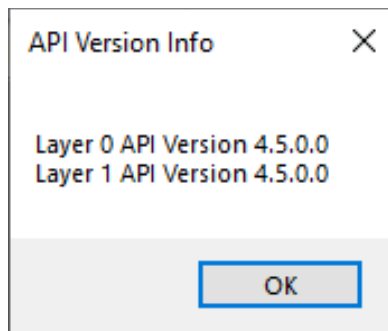

If you click on the blue circle with the '?' on the "Device Color Code" menu-strip a message box detailing the device capabilities will display:

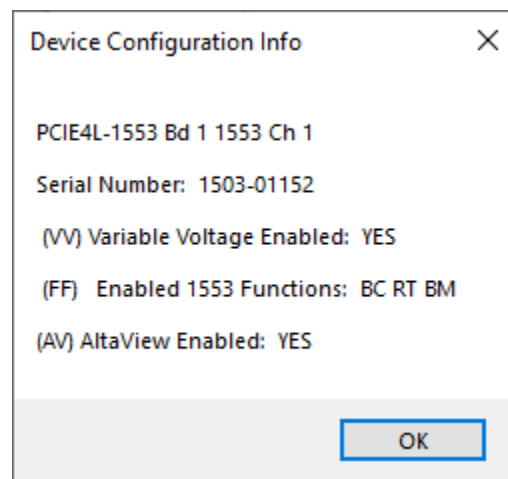

A menu-strip provides the option to set a "Device Color Code". This is useful when you have multiple devices because all the forms associated with a given device are displayed with the device color in a menu-strip. Note that this is optional – the device color will default to red for 1553 channel 1, green for 1553 channel 2, blue for 1553 channel 3, yellow for 1553 channel 4, white for 1553 channel 5, black for the Global device, dark blue for A429 bank 1, and purple for A429 bank 2. If you are using non-default device color codes, you should select the device colors before opening other forms (BM control panel, data table, etc.) because the colors in these forms are set when they are opened. If you open the forms first, then change the color for the device then the color in the forms will

not show the new color unless you close the form and reopen it. Do not use white – the software shows the selected tab in white.

Note – if you close a device information window (by selecting the X in the upper right corner) this will close the device, remove the device tab, and close all windows associated with that device.

Once the desired devices have been opened, you will use the Device Selection tab-bar to select the device to be used by controls on the ribbon-bar. The tab turns white when selected.

ENET, NLINE-E and MEZ-E Devices

The device information window for ENET (NOTE: ENET references apply to NLINE-E and MEZ-E devices as well) devices provides additional information about the ENET connection status.

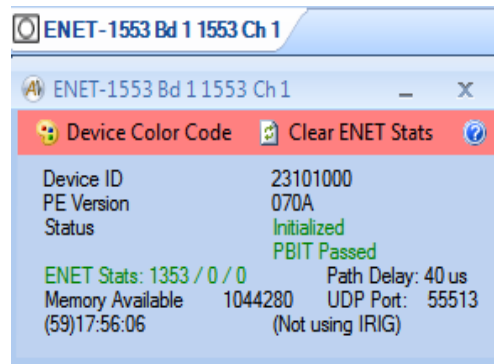

The “ENET Stats” field shows the number of Transactions / Retries / Failures (using the ADCP protocol, which is discussed in Appendix F). If there have been no retries or failures this will be in green. If there have been retries but no failures this will be in dark yellow – it is normal to have some retries. If there have been any failures this will be in red. A failure is a transaction that could not complete successfully after three attempts.

The menu-strip provides an option to “Clear ENET Stats” – this button will clear the ENET Statistics, reset to the green state, and recalculate the ENET path delay.

The “Path Delay” is the average time to execute an ADCP (Alta Device Control Protocol) transaction over the network. This is only updated when the device is opened or when the user clicks the “Clear ENET Stats” option on the menu-strip. On a wireless network (or a very busy network) you can see very high path delays. On a dedicated point-to-point wired network with only the ENET device and the controlling computer you can see very low path delays.

The recommended configuration is a point-to-point network between the client computer and the ENET device with no other devices on the network. This should be a Gigabit Ethernet connection for best results. It is NOT recommended to use anything slower than 100Mbit Ethernet. It is NOT recommended to use a wireless network connection.

The Path Delay is the total time it takes for the software to initiate a read operation, which the API executes as an ADCP transaction, where a command packet is sent through the operating system network stack to the NIC to be transmitted on the network, then waits for the response packet from the ENET device, which must be received by the NIC, processed back up through the operating system network stack and returned to the API, which extracts the read data and returns it to *AltaView*.

The Path Delay for your system and network will determine how fast you can get data from the ENET device. For the ENET-1553, this determines how many 1553 messages per second you can keep up with. For 1553 the most demanding area is the Bus Monitor because CDP message buffers must be read as fast as possible to prevent data loss. Remote Terminal and Bus Controller applications are generally not as demanding in terms of the amount of data that needs to be moved.

Measuring the Path Delay of your system and network gives you a snapshot of your system performance at the time the measurement was performed. This does NOT account for varying conditions on the network, periods of heavy network traffic, or other variables that affect the network. Therefore the Path Delay is a GENERAL INDICATOR of the performance you can expect with the ENET device on your system and network. ALTA CANNOT AND DOES NOT GUARANTEE ERROR-FREE OPERATION ON YOUR NETWORK.

A majority of network performance is based on packets per second (so bit rate is a factor, but computer systems usually are limited to how many packets per second they can process). The following formula can be used to estimate the number of 1553 messages per second that you can expect to keep up with (as Bus Monitor) on your network with an ENET-1553 device:

$$\text{MsgsPerSecond} = 1 / (7 * \text{PathDelayInSeconds})$$

For example, if we have a Path Delay of 100 microseconds then we can expect to keep up with a message rate of 1400 messages per second. Note that this is a general, **very** conservative estimate, not an absolute boundary – you can monitor data at higher message rates but you may start to drop messages if you cannot read the messages faster than they are received on the 1553 bus. High message rates can also cause the software to slow down or lock up because it is continuously processing UDP packets trying to read the messages.

AltaView Time Stamps – Date/Time Format

The Alta hardware uses a 64-bit time-stamp with 20ns LSB. At the hardware level this is a free-running counter with no relationship to date or time of day – the counter starts at zero when the device is powered up and increments from there.

Software Versions Before 2.6.5.2

The *AltaView* software sets this counter to match PC time when the device is initialized, and provides an option to convert time-stamps to the equivalent IRIG time. This gives us a method to timestamp messages/labels in a year/day/time format. **The value used to set the time registers is the 64-bit, 20ns LSB time since 00:00:00 on 1 JAN 2000, assuming all years have 365 days (does not add extra days for leap years).** If the current year is a leap year the extra day is included in the day-of-year. The following C# code shows how we set the time registers to match PC time:

```
DateTime DateAndTime;
UInt64 timeVal;
UInt32 timeHigh, timeLow;

// Read System Time and program this to timestamp clock registers.
// 64-bit, 20ns LSB, 50MHz clock.
DateAndTime = DateTime.Now;
int year = DateAndTime.Year;
int century = year / 100;
year = year - (century * 100); // Now we have two-digit year value
timeVal = (UInt64)year * 365 * 24 * 60 * 60 * 50000000;
timeVal += (UInt64)DateAndTime.DayOfYear * 24 * 60 * 60 * 50000000;
timeVal += (UInt64)DateAndTime.Hour * 60 * 60 * 50000000;
timeVal += (UInt64)DateAndTime.Minute * 60 * 50000000;
timeVal += (UInt64)DateAndTime.Second * 50000000;
timeVal += (UInt64)DateAndTime.Millisecond * 50000;

timeHigh = (UInt32)(timeVal >> 32);
timeLow = (UInt32)(timeVal & 0xFFFFFFFF);
llErrorStatus = API.m1553_TimeSet(DevID, timeHigh, timeLow);
```

This format is backward-compatible with older versions of *AltaView* that did not include the year in the time stamp. This allows us to work with the existing user-base of old CDP and RXP files. **This format does have some drawbacks, for example on January 1st following a leap year the year/day will be displayed as December 31st of the leap year.**

Software Versions 2.6.5.2 and Later

In version 2.6.5.2 the time format was changed to handle leap years correctly.

The value used to set the time registers is the 64-bit, 20ns LSB time since 00:00:00 on 1 JAN 2000 (DOES add extra days for leap years). If the current year is a leap year the extra day is included in the day-of-year. The following C# code shows how we set the time registers to match PC time:

```
/* NEW CODE - includes leap years */
DateAndTime = DateTime.Now;
int year = DateAndTime.Year;
int tempyear = 2000;
int daysInYear = 365;

timeVal = 0;
while (tempyear < year)
{
    // If year is evenly divisible by 4 but NOT evenly divisible by 100,
    // or is evenly divisible by 400 then it is a leap year.
    if (((tempyear % 4) == 0) && ((tempyear % 100) != 0) ||
        ((tempyear % 400) == 0))
    {
        daysInYear = 366;
    }
    else daysInYear = 365;

    timeVal += (ulong)daysInYear * 24 * 60 * 60 * 50000000;
    tempyear++;
}

/* Convert 1-indexed day of year to 0-indexed day */
timeVal += ((UInt64)DateAndTime.DayOfYear-1) * 24 * 60 * 60 * 50000000;
timeVal += (UInt64)DateAndTime.Hour * 60 * 60 * 50000000;
timeVal += (UInt64)DateAndTime.Minute * 60 * 50000000;
timeVal += (UInt64)DateAndTime.Second * 50000000;
timeVal += (UInt64)DateAndTime.Millisecond * 50000;

timeHigh = (UInt32)(timeVal >> 32);
timeLow = (UInt32)(timeVal & 0xFFFFFFFF);
llErrorStatus = API.m1553_TimeSet(DevID, timeHigh, timeLow);
```

This new format handles leap years and year rollover correctly. If you use the File Viewer in the newer version of **AltaView** to open a CDP/RXP/CWP file that was recorded with the older time format, the Days will be off by the number of leap years after year 2000.

The following C# code shows how we can take a 64-bit 20ns time stamp and convert it to a time string for display:

```
/* This is the NEW code */
// Internal function to convert 64-bit time to a string for display
private string time2string2000(UInt32 TimeHigh, UInt32 TimeLow)
{
    UInt64 time64, time64_seconds, time64_nanoseconds;
    UInt64 dayclock, dayno;
    UInt64 year = 2000;
    UInt64 nanosecond, microsecond, millisecond, day, hour, minute,
second, daysInYear;
    string rsltString;

    time64 = TimeHigh; time64 = time64 << 32; time64 |= TimeLow;

    rsltString = "";

    /* Get sub-seconds (in nanoseconds) from 64-bit value, 20ns LSB */
    time64_nanoseconds = (time64 % 500000000L) * 20L;

    nanosecond = time64_nanoseconds % 1000L;
    microsecond = (time64_nanoseconds % 1000000L) / 1000L;
    millisecond = time64_nanoseconds / 1000000L;

    /* Get seconds from 64-bit value with 20ns LSB */
    time64_seconds = time64 / 500000000L;

    dayclock = time64_seconds % (24L * 60L * 60L);
    dayno = time64_seconds / (24L * 60L * 60L);

    second = dayclock % 60;
    minute = (dayclock % 3600) / 60;
    hour = dayclock / 3600;

    year = 2000;
    // If year is evenly divisible by 4 but NOT divisible by 100,
    // or is evenly divisible by 400 then it is a leap year.
    if (((year % 4) == 0) && ((year % 100) != 0) ||
        ((year % 400) == 0))
    {
        daysInYear = 366;
    }
    else daysInYear = 365;

    while (dayno >= daysInYear)
    {
        dayno -= daysInYear;
        year++;

        // If year is evenly divisible by 4 but NOT divisible by 100,
        // or is evenly divisible by 400 then it is a leap year.
        if (((year % 4) == 0) && ((year % 100) != 0) ||
            ((year % 400) == 0))
        {
            daysInYear = 366;
        }
    }
}
```

```

    }
    else daysInYear = 365;
}

/* convert day from 0-indexed to 1-indexed */
day = dayno + 1;

rsltString += "[" + year.ToString() + "];";
rsltString += "(" + day.ToString() + ");";
rsltString += hour.ToString("d2") + ":";
rsltString += minute.ToString("d2") + ":";
rsltString += second.ToString("d2") + ".";
rsltString += millisecond.ToString("d3") + ".";
rsltString += microsecond.ToString("d3") + ".";
rsltString += nanosecond.ToString("d3");

return rsltString;
}

```

The new time format is very similar to UNIX epoch time (seconds since 00:00:00 1 JAN 1970). The main difference is that the **AltaView** time format is time since 00:00:00 1 JAN 2000 (and is 64-bit with 20ns LSB). This works better with things like IRIG-B time sources where the year starts at 2000 – IRIG-B can provide a 2-digit BCD Year of Century (00 to 99) that assumes it starts at year 2000.

Ethernet “Precision Time Protocol” (PTP) uses UNIX epoch time with a 1ns LSB (nanoseconds since 00:00:00 1 JAN 1970). We can convert this to the **AltaView** time format by subtracting the UNIX epoch time for 00:00:00 1 JAN 2000 (946684800 seconds), and converting to a 20ns LSB (by dividing by 20).

Chapter 2 – Global Tools

The “Global” tab on the ribbon-bar provides tools that are not specific to a particular protocol or device type.

Localization Tools

AltaView will detect the localization/language settings of the system on start-up and will automatically use the closest supported language (or default to English). However, the user may wish to manually select the language for the **AltaView** interface. The localization tools provide the means to do this.



AltaView currently supports English, Chinese, Japanese, French, German, Spanish, and Italian.

Board-Level Tools

The Board-Level Tools can ONLY be used for the “Global” device on an Alta Board. As the name indicates, these tools apply to the entire board and provide access to the board-level global registers.

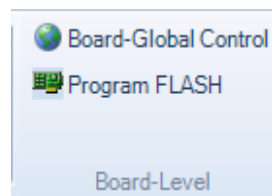

Board-Global Control

The Board-Global Control Panel is used to control the board-level global registers.

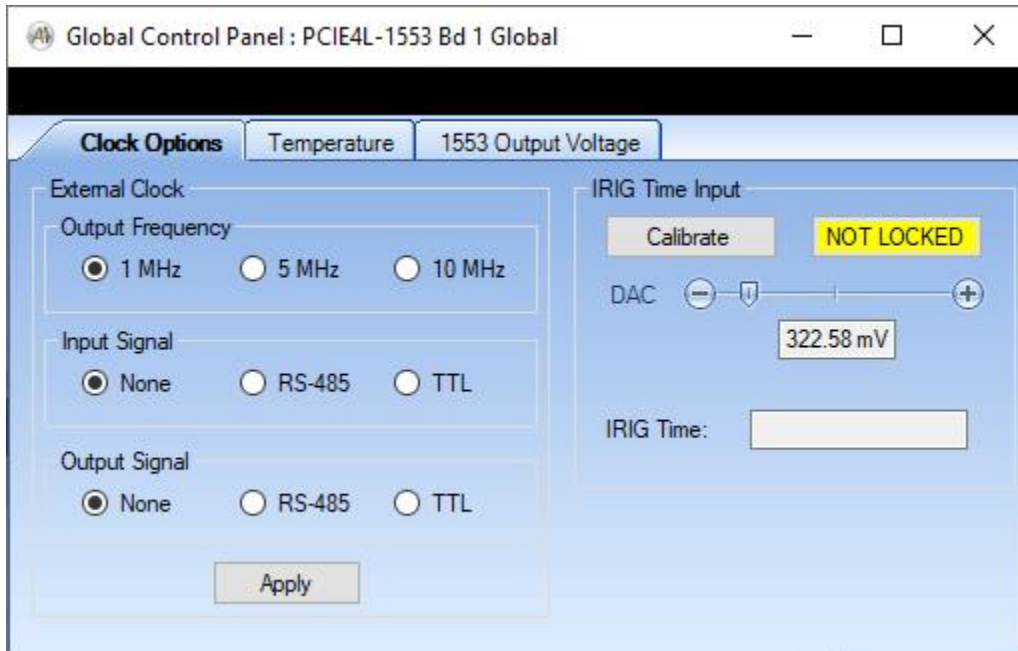

Clock Options

The Clock Option tab allows you to configure the board for use with an external clock signal. This is useful for applications that need multiple Alta channels and/or boards to be time synchronized. This tab also allows you to calibrate the IRIG clock input.

External Clock

The External Clock settings specify the input and output external clock settings.

The **Frequency** selection determines the frequency of the output clock signal generated by the board. Possible values are 1MHz, 5MHz, or 10MHz.

The **Input Signal** selection determines which inputs to the board to use for the external clock input.

- If "None" is selected then the input external clock is disabled.
- If "RS-485" is selected then the differential "DDISC1" RS-485 lines will be used as the external clock input.
- If "TTL" is selected then the "EXT CLOCK" line will be used as the external clock input.

The **Output Signal** selection determines which outputs to the board to use for the external clock output.

- If “None” is selected then the output external clock is disabled.
- If “RS-485” is selected then the differential “DDISC1” RS-485 lines will be used as the external clock output.
- If “TTL” is selected then the “EXT CLOCK” line will be used as the external clock output.

Note that if the RS-485 option is used for the external clock, the input and output clocks use the SAME PINS. Therefore, the input clock for all channels on the board are automatically connected to the output clock, so you can time synchronize multiple channels on the same board and also test the external clock on those channels without any external connection. Of course, if you need to synchronize with other boards then one board should be configured to output a clock signal and connected to the appropriate external clock input lines on the other boards (which are configured to accept the external clock signal and will NOT generate an output clock).

NOTE: After configuring the external clock options at the board-global level you will need to configure the individual channels to use the external clock rather than the internal clock. For 1553 channels, this is done through the “Time Options” button on the 1553 ribbon bar.

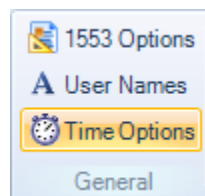

Please refer to Chapter 3 (MIL-STD-1553 Tools) for more information on configuring the Time Options at the channel-level.

IRIG Time Input

This panel allows you to calibrate the board for an IRIG-B input signal. It also displays status of the IRIG signal (locked or not locked). If the signal is locked, it displays the current IRIG time.

Alta products use **IRIG Standard 200-04** and support these IRIG time codes:

IRIG-B002 (Format B, DC Level Shift, no carrier, BCD Time Of Year)

IRIG-B006 (Format B, DC Level Shift, no carrier, BCD Time Of Year, BCD Year)

IRIG-B122 (Format B, AM, 1KHz carrier, BCD Time Of Year)

IRIG-B126 (Format B, AM, 1KHz carrier, BCD Time Of Year, BCD Year)

The Alta IRIG decoder does not use the coded expressions for **Control Flags (CF)** or **Straight Binary Seconds (SBS)**.

WARNING: The older **IRIG Standard 200-98** did not include **BCD Year** and used the bits in P5 through P8 for **Control Flags (CF)**. The newer **IRIG Standard 200-04** reserves P5 through P6 for **BCD Year** and restricts Control Flags to P6 through P8. Non-zero Control Flag bits in P5 through P6 will be seen as BCD Year by the Alta IRIG decoder.

More information on IRIG time-code formats can be found here:

<http://www.irigb.com/pdf/wp-irig-200-04.pdf>

To calibrate your board to the IRIG signal, first make sure you have connected the IRIG signal to the board (refer to the appropriate Hardware Manual for the type of Alta board you are using, note that you must have a cable assembly with the optional Auxiliary connector for the IRIG signal). Now you can click the “Calibrate” button. **IT MAY TAKE SEVERAL SECONDS TO COMPLETE THE CALIBRATION PROCESS.** If calibration succeeded you should now be locked on the IRIG signal and the current IRIG time will be displayed. The DAC slider control can be used to manually adjust the IRIG DAC to lock onto the signal. If you save the **AltaView** configuration with the Global Control Panel open then the IRIG DAC setting will be saved in the configuration file.

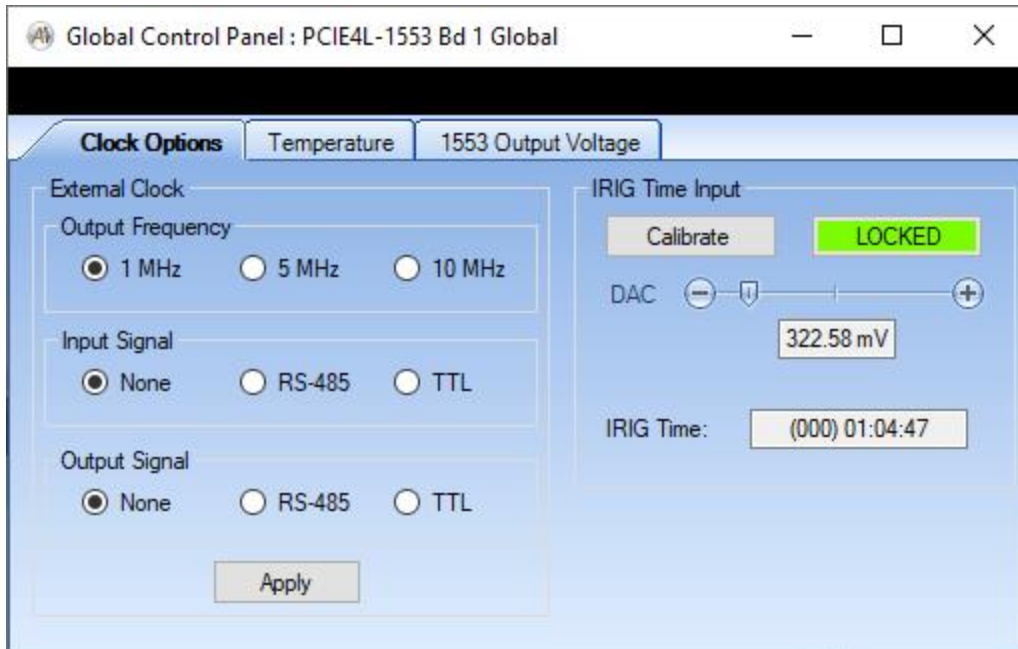

NOTE: After calibrating the IRIG time input at the board-global level you will need to configure the individual channels to use IRIG time. For 1553 channels, this is done through the “Time Options” button on the 1553 ribbon bar.

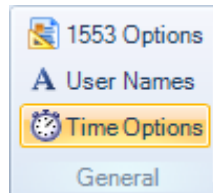

Please refer to Chapter 3 (MIL-STD-1553 Tools) for more information on configuring the Time Options at the channel-level.

Temperature

Alta 1553 boards have two on-board temperature sensors – one near the FPGA and one near the 1553 transceivers. The Temperature tab displays the output of these temperature sensors.

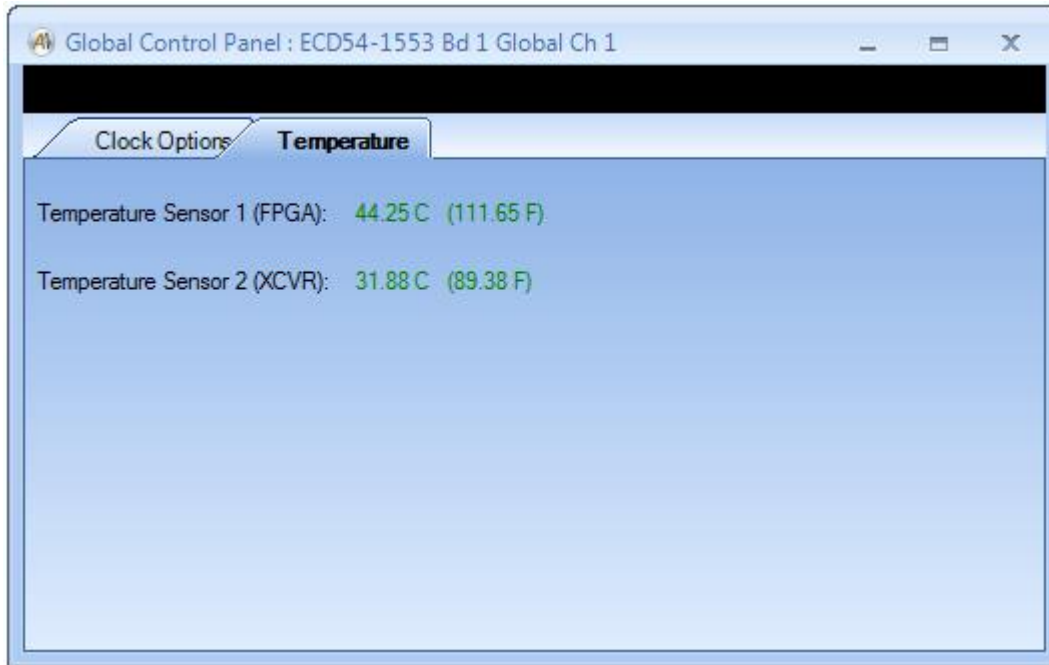

The temperature sensors have a range of -128 to +128 degrees Celsius (in steps of 0.125 degrees Celsius). Temperatures from 0 to 50 degrees Celsius are displayed in green. Temperatures above 50 degrees Celsius are displayed in red. Temperatures below 0 degrees Celsius are displayed in blue.

1553 Output Voltage

If the board is configured for the 1553 Variable Voltage option, the Board-Global Control Panel will display the 1553 Output Voltage tab.

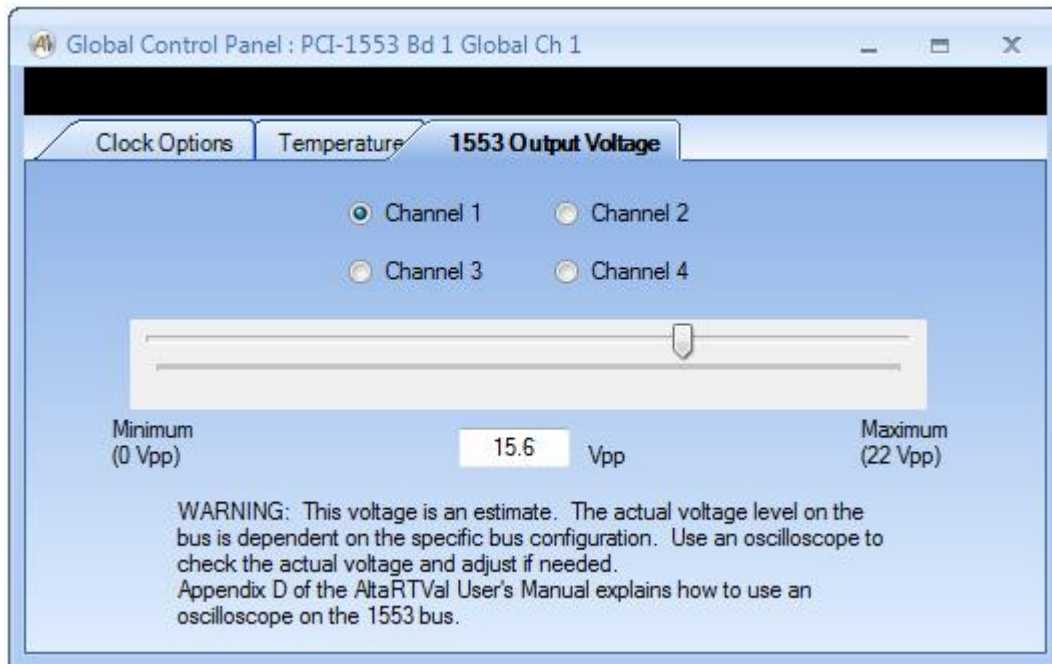

Radio buttons will be displayed for the 1553 channels available on the board. You must select a channel to enable the voltage track-bar control. Use the track-bar control to set the desired output voltage level. You can also enter the desired voltage in the text-box below the track-bar (must be from 0 to 22 volts).

The approximate output voltage is displayed below the track-bar. You can use an oscilloscope to check the actual voltage – Appendix D of the *AltaRTVal* Software User's Manual explains how to use an oscilloscope on the 1553 bus.

A429 Output Voltage

If the board is configured for the A429 Variable Voltage option, the Board-Global Control Panel will display the A429 Output Voltage tab.

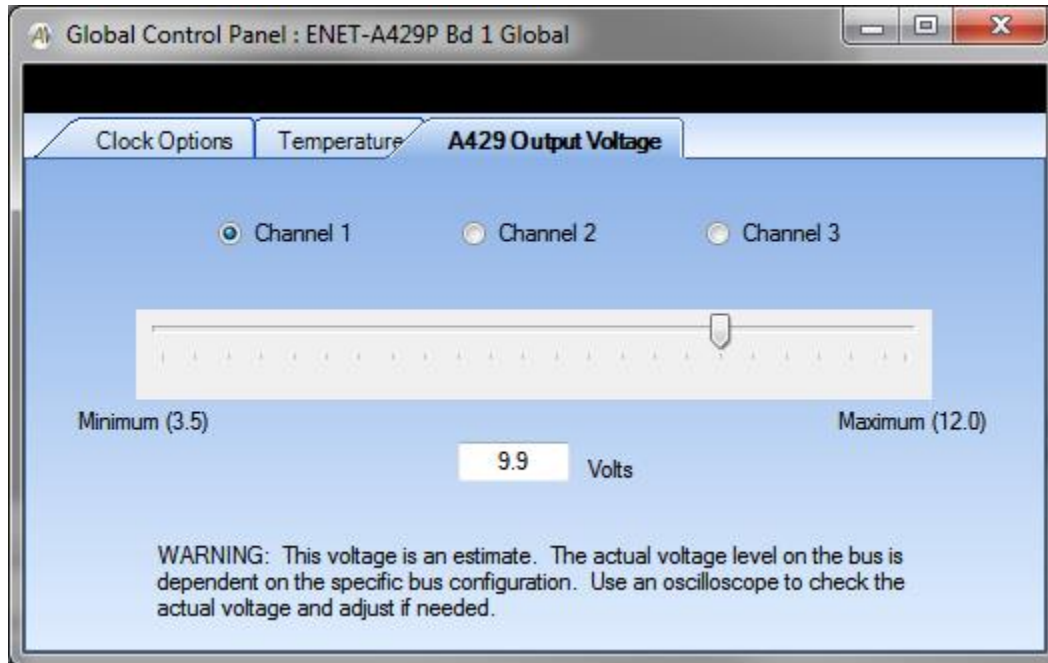

Radio buttons will be displayed for the Variable Voltage-enabled A429 channels available on the board. You must select a channel to enable the voltage track-bar control. Use the track-bar control to set the desired output voltage level. You can also enter the desired voltage in the text-box below the track-bar (must be from 3.5 to 12 volts).

Program FLASH

AltaView provides a tool to program a firmware load from a file into the FLASH memory on the board. This allows firmware updates to be sent by e-mail or downloaded rather than requiring users to return boards to Alta for firmware updates. Note that the device information window displays the current firmware version (PE version).

WARNING – Make sure that you have a valid Alta BIT file containing the firmware data before selecting the Program FLASH tool.

NOTE: **AltaView** does not support loading firmware on the PCCARD-1553 or PCCARD-A429 products. Contact the factory for information on upgrading firmware for these products.

WARNING – Programming FLASH memory affects all channels on the board. You should first close all devices other than the device to be programmed (Global Device).

When you click on the “Program FLASH” tool a check is made for active devices.

If AltaView detects that any of the 1553, A429 or WMUX channels on the Alta board are currently in use the following message will be displayed:

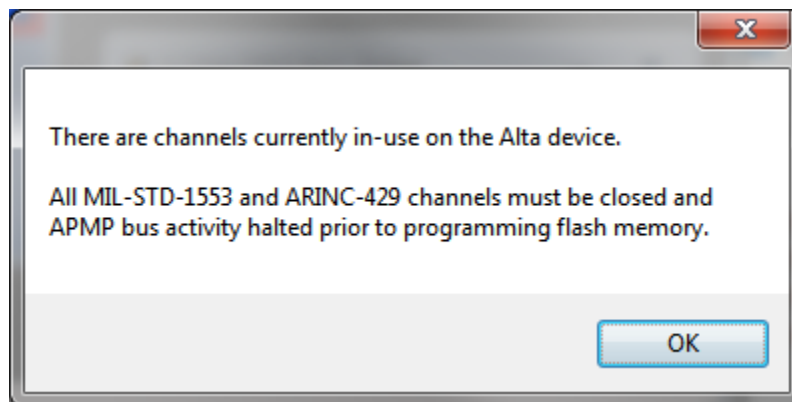

If none of the channels on the board are active then flash programming will proceed as follows:

First a warning dialog box will be displayed – ***if you are not absolutely sure you want to program the board then hit CANCEL.***

If you hit OK, another dialog box will be provided for you to select the BIT file to load – ***if you cannot find the desired BIT file or if you have changed your mind about programming the board then hit CANCEL.***

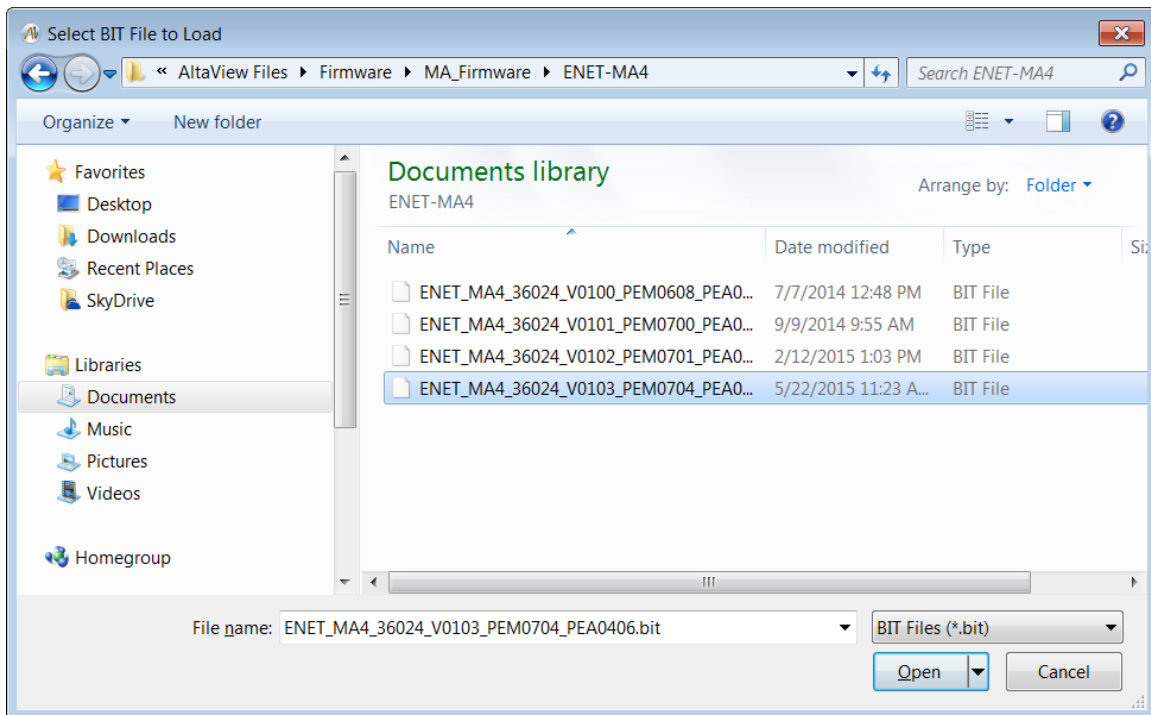

WARNING – If you program FLASH with an invalid file then the board will no longer work. You will have to return the board to Alta to be reconfigured.

The BIT file name includes a product code. In the example above this is 36024 for the ENET-MA4 product. If you select a BIT file that has the wrong product code for the device you are using then the software will display an error.

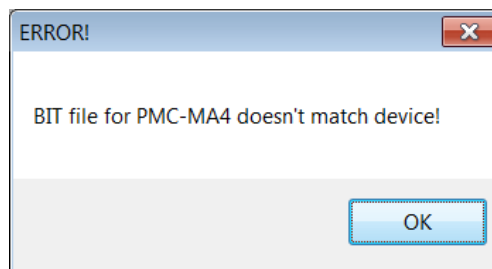

You will have to restart the program flash steps and select a BIT file that matches your device.

If you have a good BIT file, another dialog box will be provided for you to select the Log file to write. This will save basic information on the flash programming operation that can be useful if a problem occurs. If you have difficulty programming your device you can send this Log file to Alta so we can troubleshoot the problem.

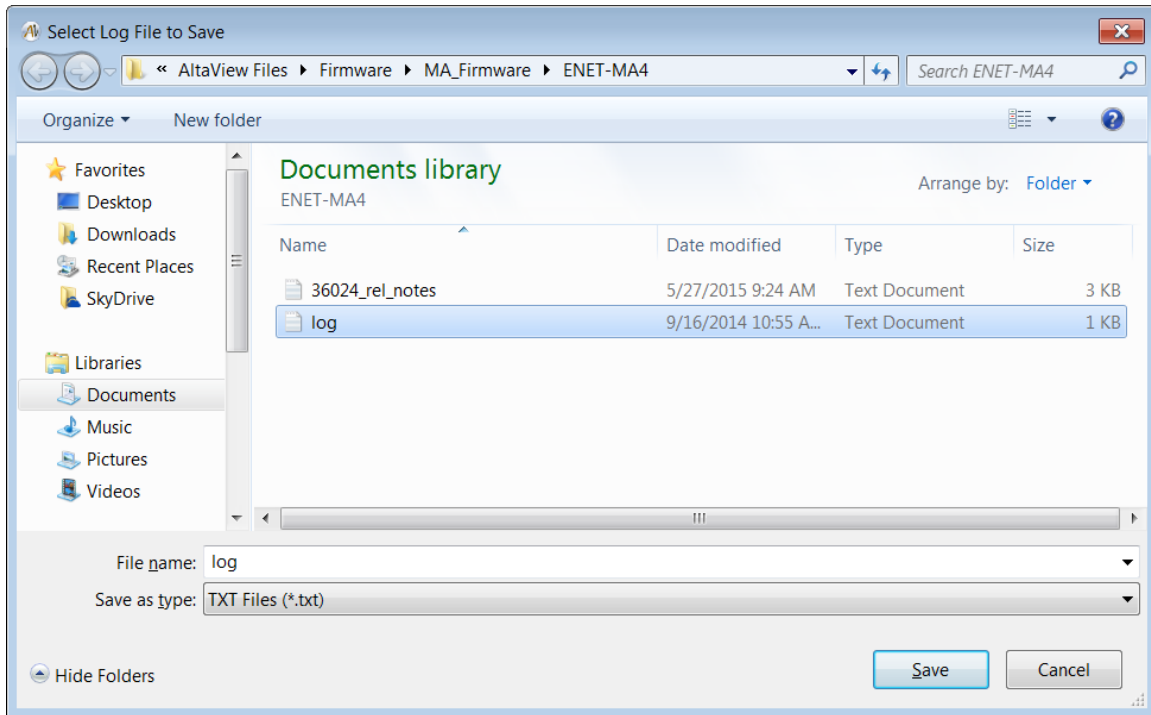

If you hit save and a file has been selected, a warning will be displayed as shown below:

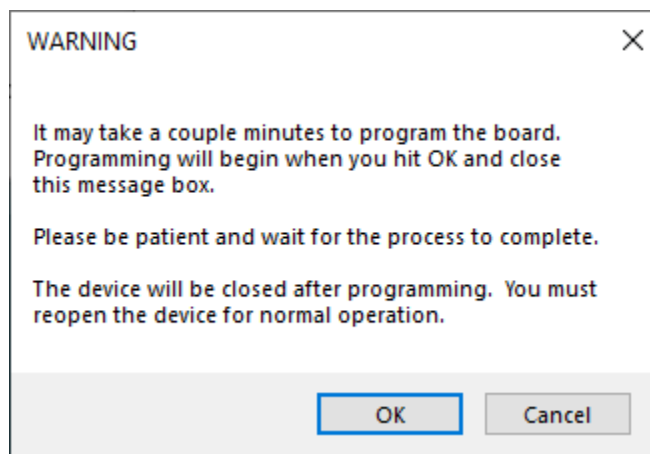

Some devices (like ENET products, the ENET-MA4 takes longer than most other devices) can take several minutes to program and the progress bar may restart several times, BE PATIENT!

DO NOT INTERRUPT THE PROGRAMMING PROCESS. If this process is interrupted the firmware load will fail and the device will have to be returned to Alta to be reconfigured.

The main *AltaView* form will show programming status:

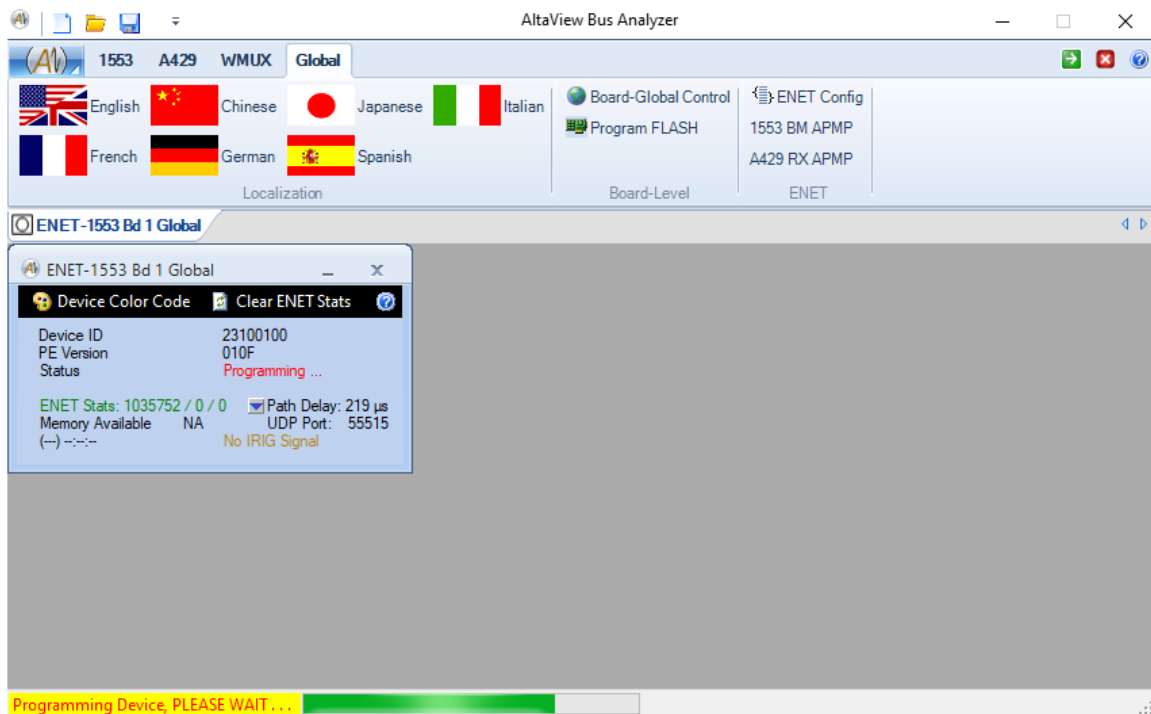

When the programming is complete the results will be displayed:

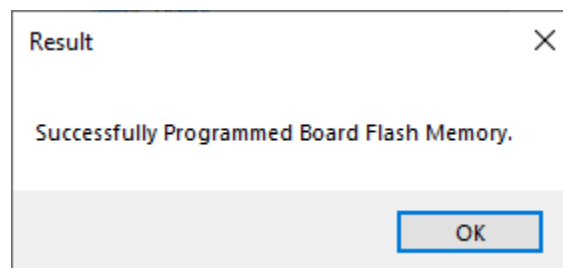

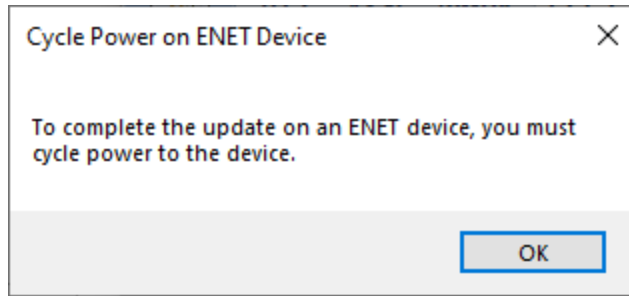

When the process is complete the device will be closed. Reopen the device and verify that the new firmware version is displayed in the device information window.

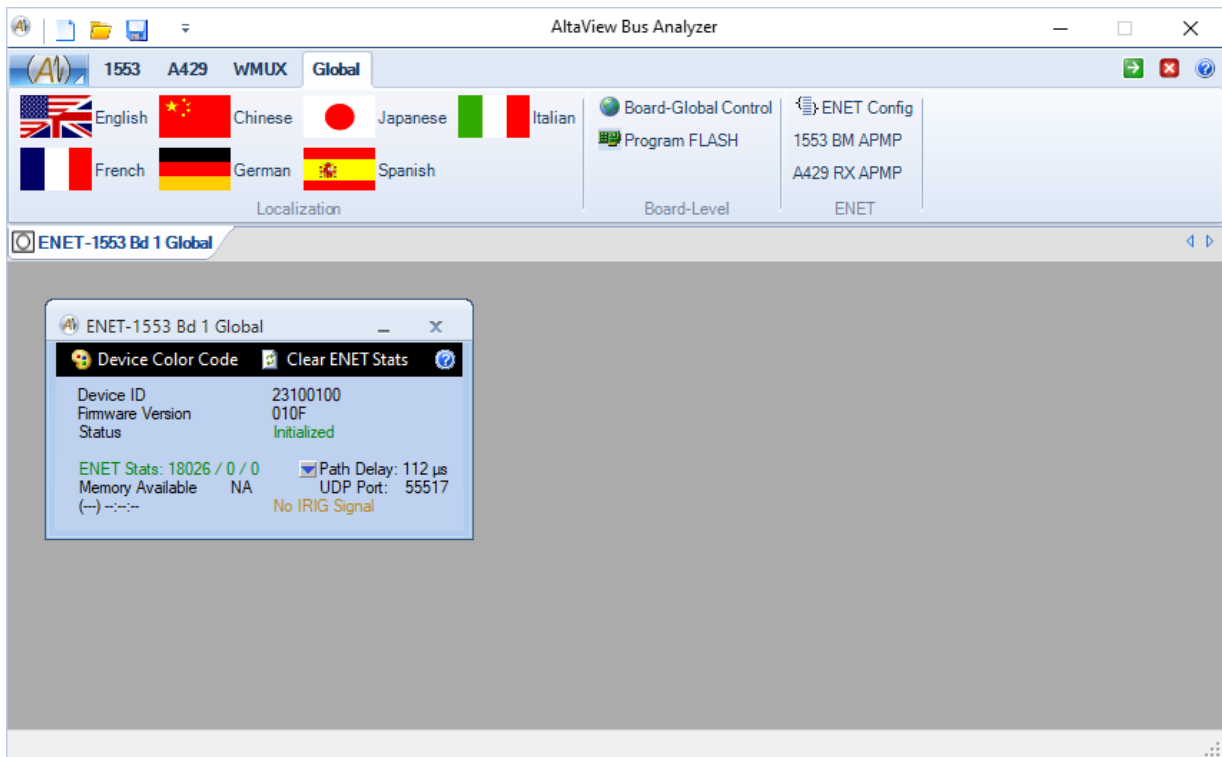

ENET Tools

The ENET Tools are used to configure ENET devices and to view data received through the Alta Passive Monitor Protocol (APMP).

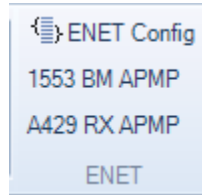

ENET Config

The ENET Config button will only be enabled if an ENET Board Global device has been opened and selected.



WARNING – Accessing the ENET Configuration reads/writes FLASH memory and this should not be done while running (1553 BM/BC/RT/APMP or A429 RX/TX/APMP). You should first close all devices other than the device to be programmed (Global Device).

When the “ENET Config” button is clicked a check is performed to detect if there are any channels in use on the ENET device.

If AltaView detects that any of the 1553 or A429 channels on the ENET device are currently in use the following message will be displayed:

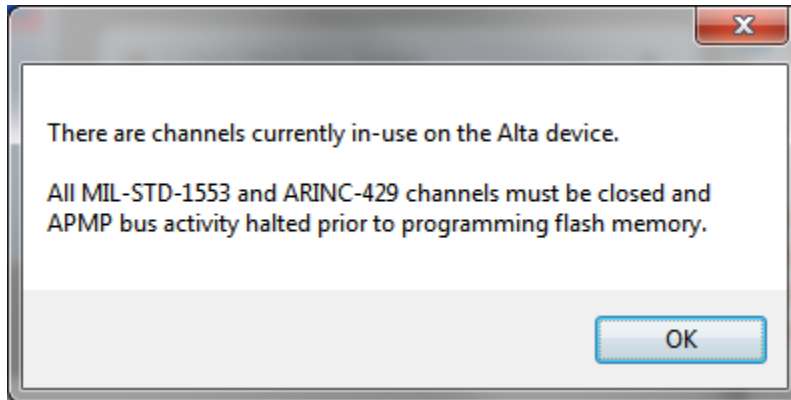

If no active channels (other than the Global device) are detected on the ENET device the dialog-box below is opened to allow the user to specify a new IP address for the device and optionally enable the ENET device to power-up in APMP mode.

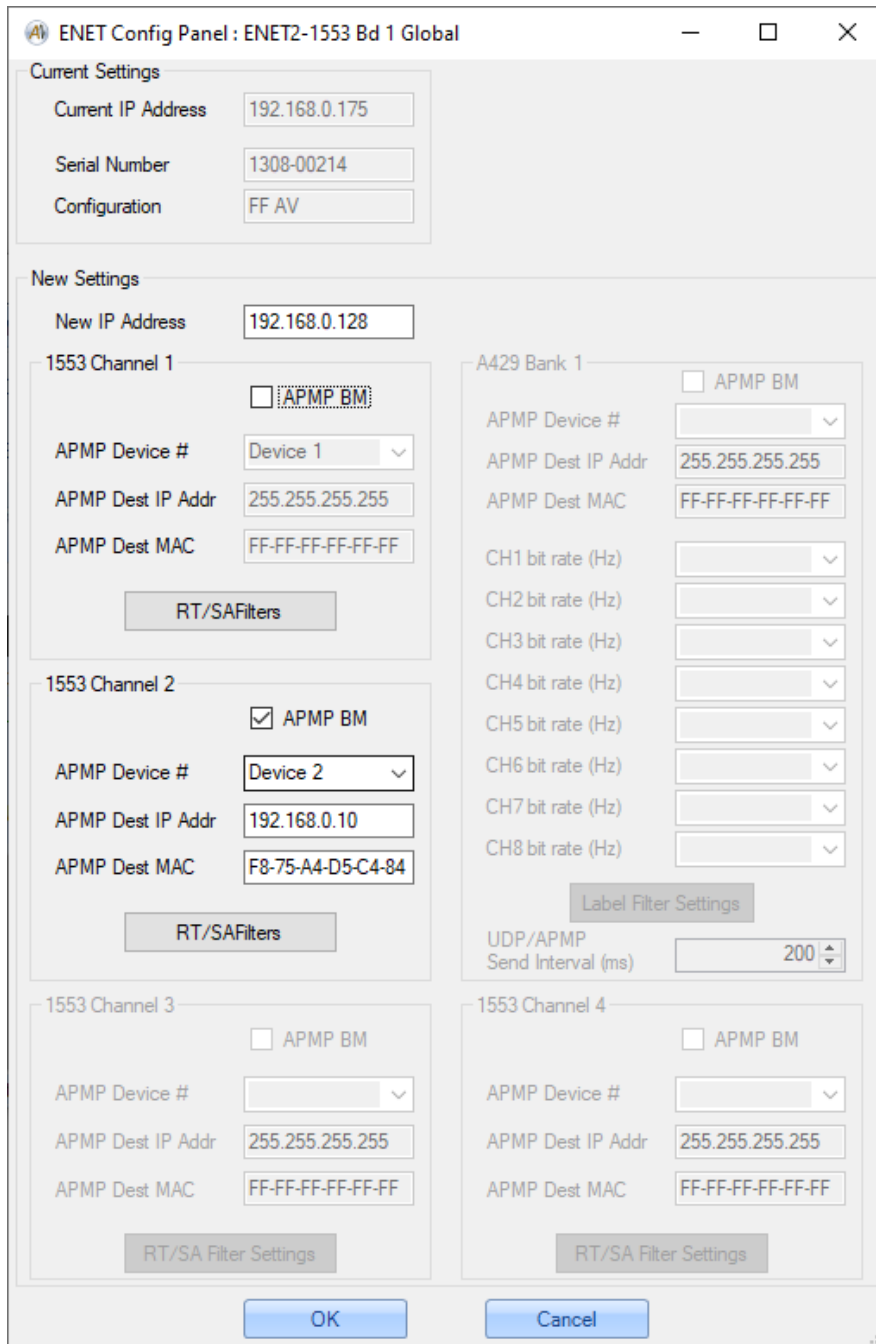

If you check the box to enable APMP BM mode this will enable the combo-box for APMP Device # and text boxes for the destination IP address and MAC address (defaults to broadcast address). The Device # determines the APMP UDP port numbers to use. If you have only one ENET device that will be in APMP mode use Device 1. If you will have multiple ENET devices in APMP mode they each need a unique Device Number – the **AltaView** software allows up to four APMP devices. When you use the APMP Control Panel to connect to an APMP device you will need to specify the APMP Device Number.

Note that there are settings for 1553 Channel 1, 1553 Channel 2, and A429 Bank 1. An ENET-1553 will only have 1553 Channel 1, an ENET2-1553 can have 1553 Channel 1 and 1553 Channel 2, an ENET-A429 and ENET-A429P will only have A429 Bank 1. An ENET-MA4 and ENETX-MA4 can have 1553 Channel 1, 1553 Channel 2, and A429 Bank 1.

Clicking OK (Ctrl-K is a short cut) will program the device with the selected settings and will close the ENET Global Device. Cycle power for the changes to take effect. The device can be reopened with the new IP address, etc. The Cancel button (<Esc Key> is a short cut) will close the dialog without make any changes to the device's ENET Configuration.

RT/SA Filters

Beginning with version 3.1.0.4, an 'RT/SA Filters' button is provided for each available 1553 channel on the ENET device. Clicking this button will open a dialog that indicates which RT/SA messages the 1553 APMP BM is currently programmed to capture from the bus. The settings may be changed by checking/unchecking boxes for SAs. Clicking the 'Apply Filters' button will save the new APMP BM filter settings to flash when 'OK' is clicked on the 'ENET Config Panel'.

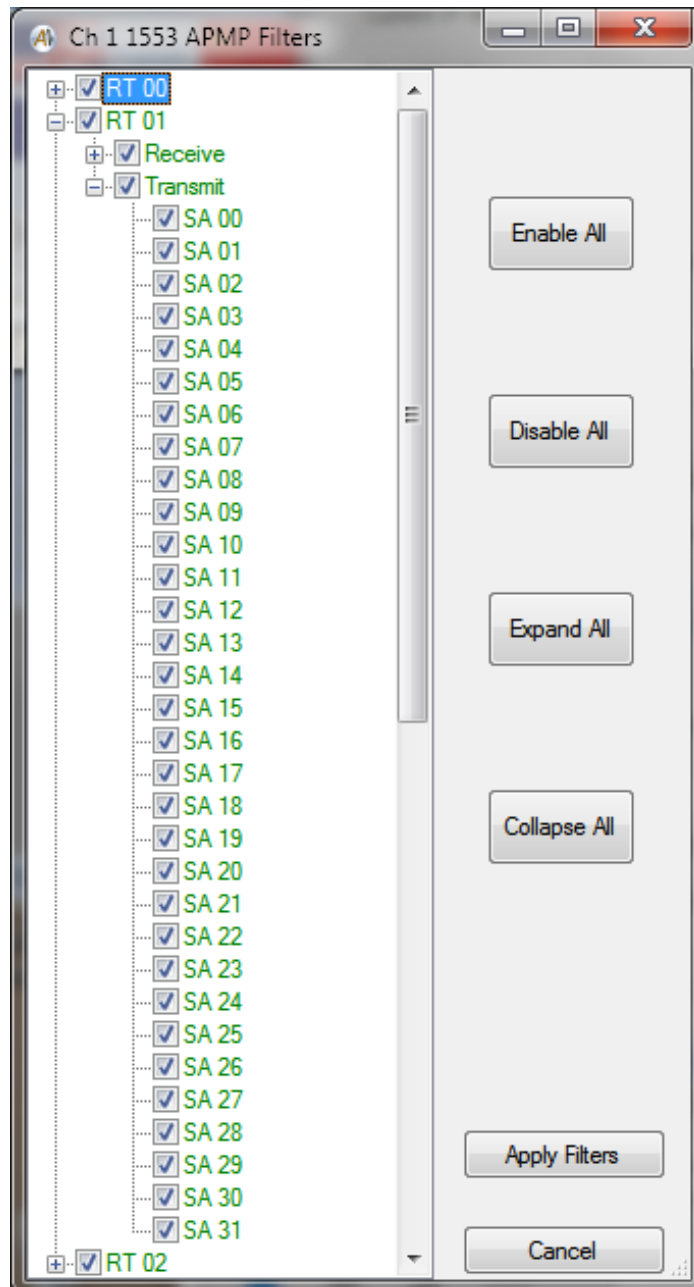

UDP/APMP Send Interval

Beginning with Alta API v4.0.0.0, this numeric entry is provided for the first A429 bank on the ENET A429-capable device. This will change the rate at which A429 APMP UDP messages are transmitted, provided that the internal FIFO is not full. The default is 200ms, and the variation can be from 1ms to 1022ms. This transmit rate and reliability is dependent on the amount of A429 being received. If the amount of data received fills the internal FIFO it will be transmitted regardless of the Send Interval value.

Label Filters

Beginning with version 4.0.0.0, a 'Label Filter Settings' button is provided for the first A429 bank on the ENET A429-capable device. Clicking this button will open a dialog that indicates which label the A429 APMP BM is currently programmed to capture from the bus. The settings may be changed by checking/unchecking boxes for labels. Clicking the 'Apply Filters' button will save the new APMP BM filter settings to flash when 'OK' is clicked on the 'ENET Config Panel'.

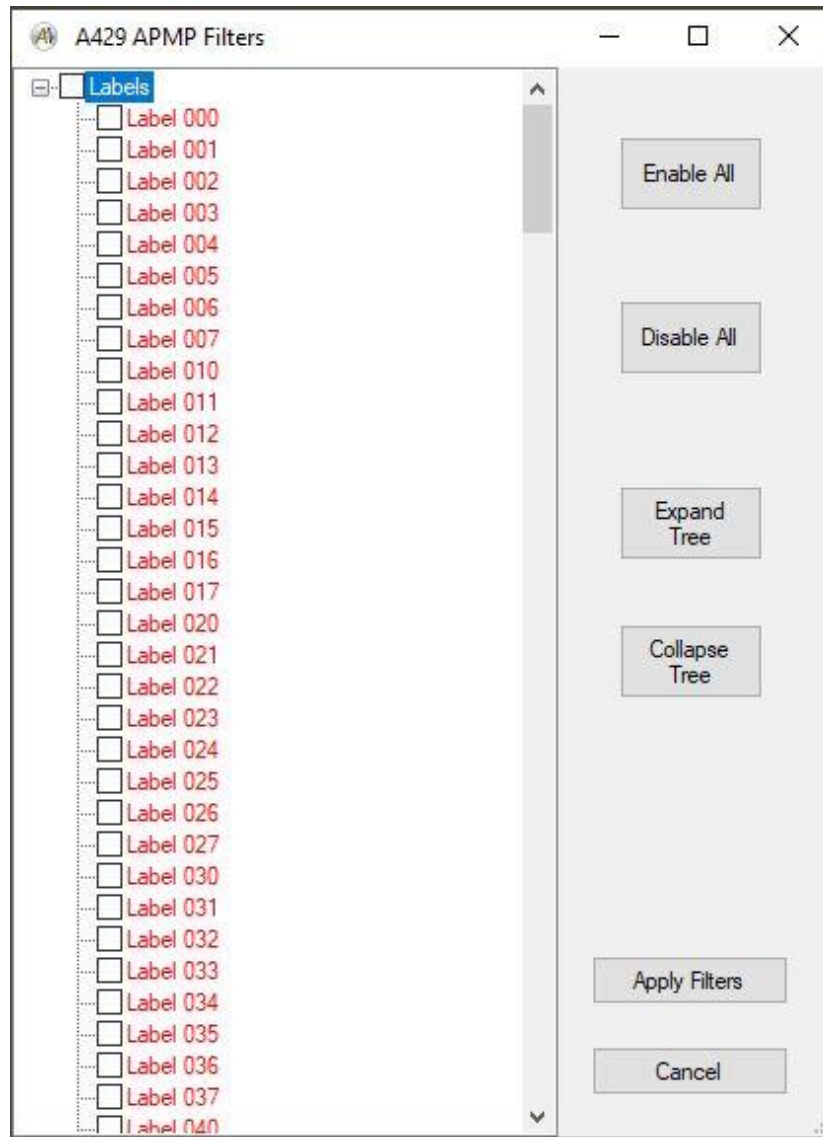

1553 BM APMP

The 1553 BM APMP tool is very similar to the 1553 BM Control Panel.

NOTE:

You will need to turn off the Windows firewall in order to receive APMP packets.

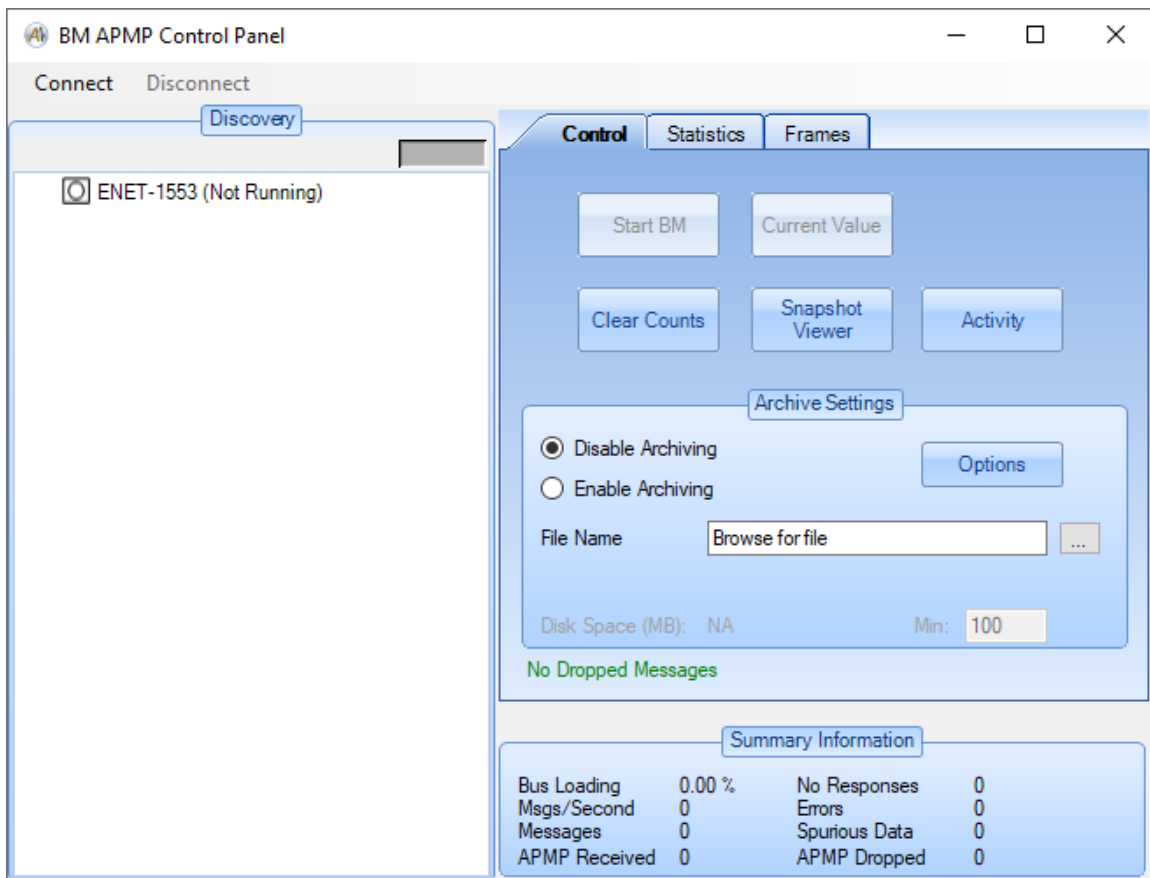

The menu-strip provides options to **Connect** and **Disconnect** to the ENET APMP device. You must connect to a device to enable the “Start BM” button.

Clicking on **Connect** opens a dialog-box where you can specify the IP address of the ENET device and the client system. You must also specify the APMP Device Number – this must match the Device Number specified in the ENET Config tool when the device was enabled for APMP mode. The *AltaView* software allows up to four APMP devices.

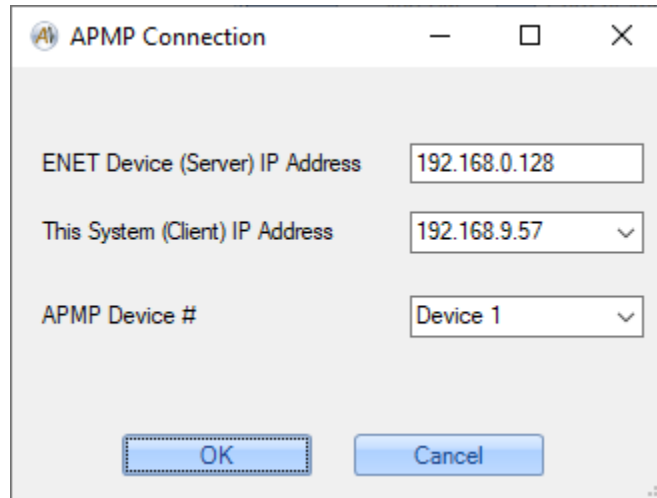

When you click the “OK” button the software will bind a socket on the client IP address and listen for APMP packets from the server IP address. This enables the “Start BM” button on the 1553 BM APMP Control Panel. Click on this button to start monitoring.

Of course, you will only receive messages if the ENET-1553 device is operating in APMP mode and is transmitting APMP packets containing 1553 messages. At this point the tool works just like the 1553 BM Control Panel.

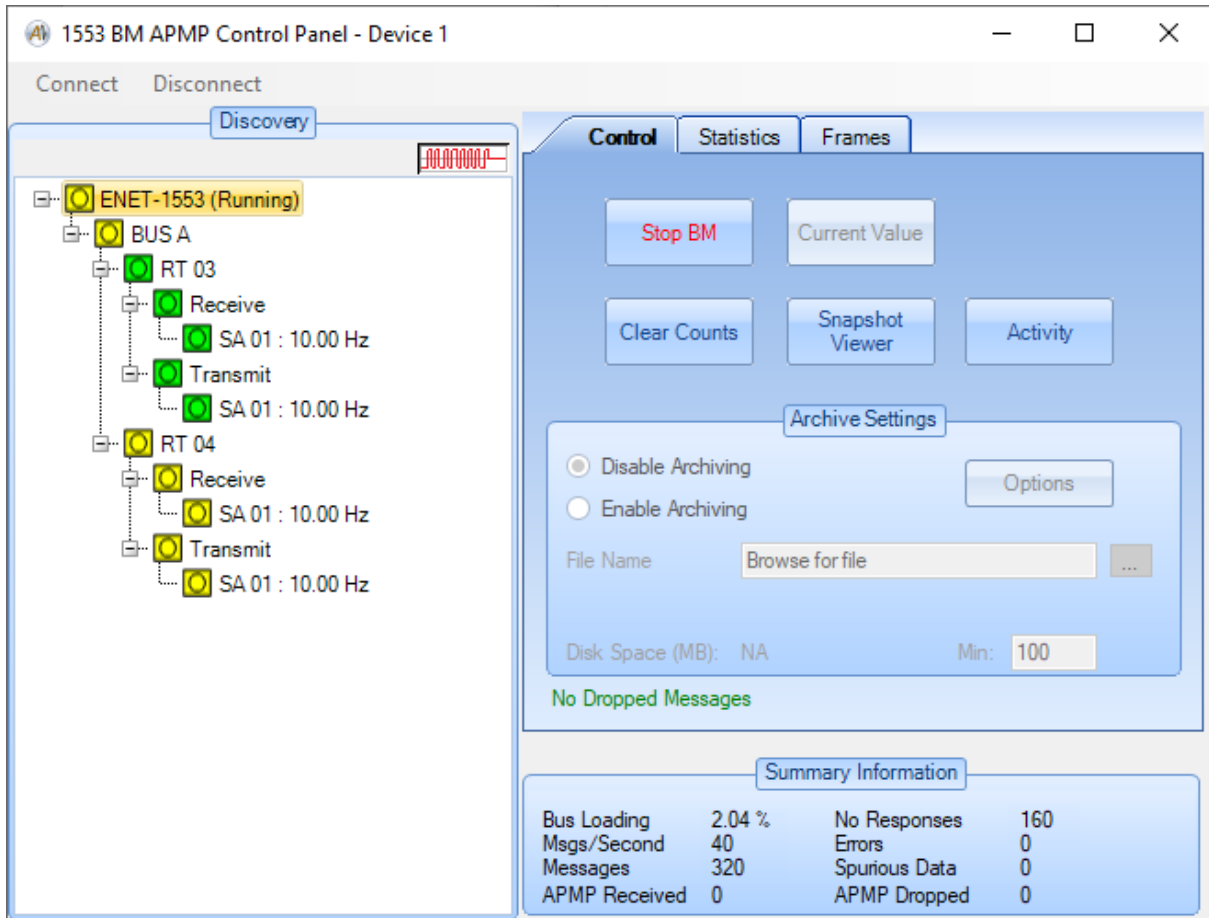

A429 RX APMP

The A429 RX APMP tool is very similar to the A429 RX Control Panel.

NOTE:

You will need to turn off the Windows firewall in order to receive APMP packets.

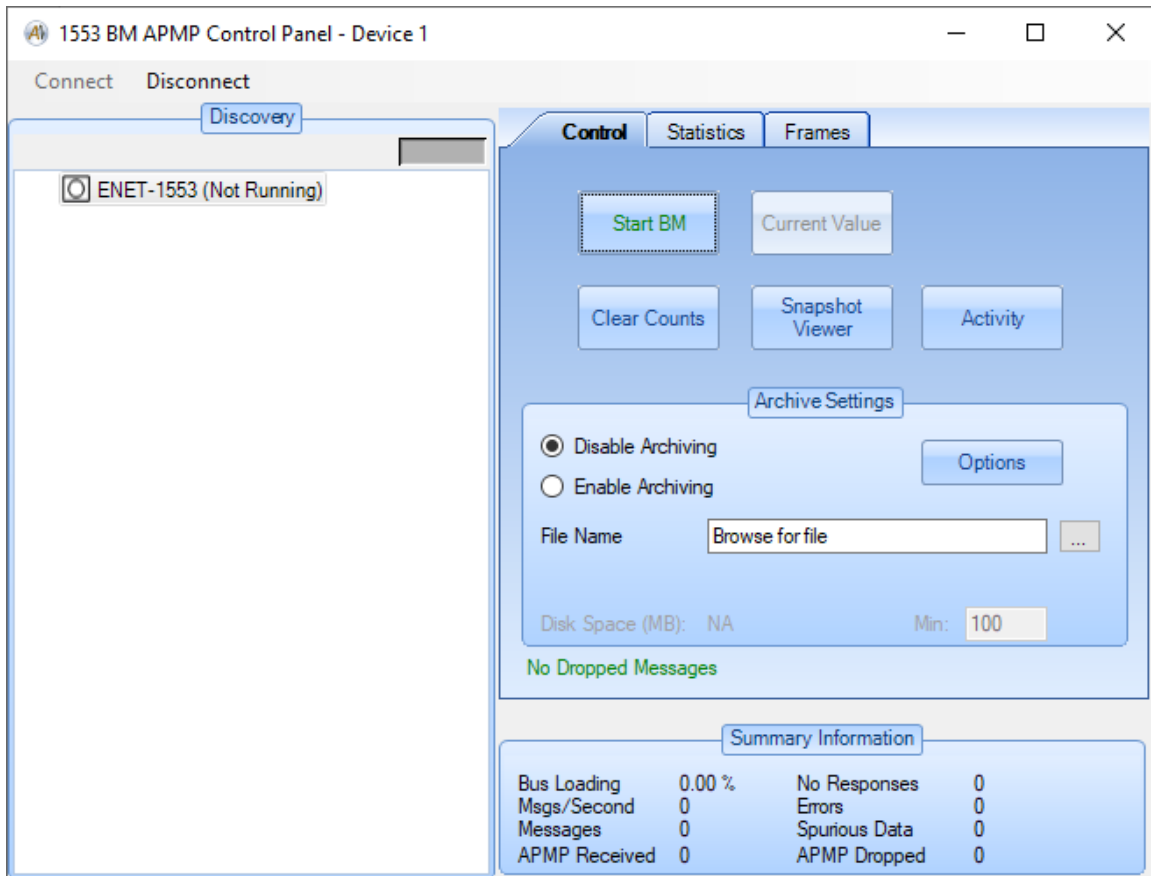

The menu-strip provides options to **Connect** and **Disconnect** to the ENET APMP device. You must connect to a device to enable the “Start RX” button.

Clicking on **Connect** opens a dialog-box where you can specify the IP address of the ENET device and the client system. You must also specify the APMP Device Number – this must match the Device Number specified in the ENET Config tool when the device was enabled for APMP mode. The *AltaView* software allows up to four APMP devices.

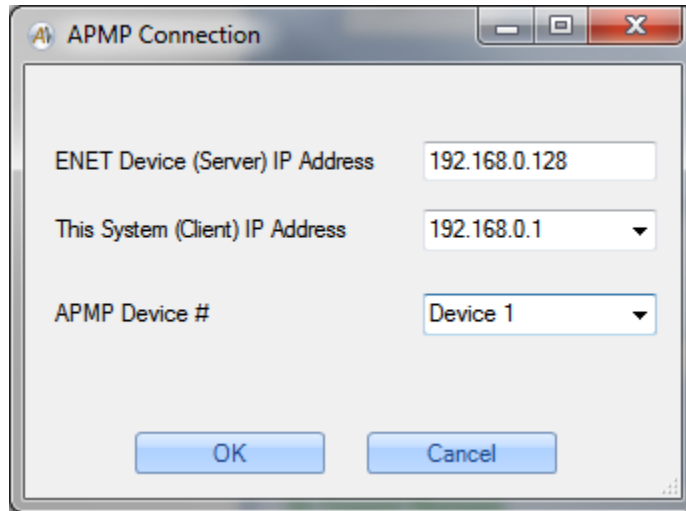

When you click the “OK” button the software will bind a socket on the client IP address and listen for APMP packets from the server IP address. This enables the “Start RX” button on the A429 RX APMP Control Panel. Click on this button to start monitoring.

Of course, you will only receive messages if the A429 channel is operating in APMP mode and is transmitting APMP packets containing A429 labels. At this point the tool works just like the A429 RX Control Panel.

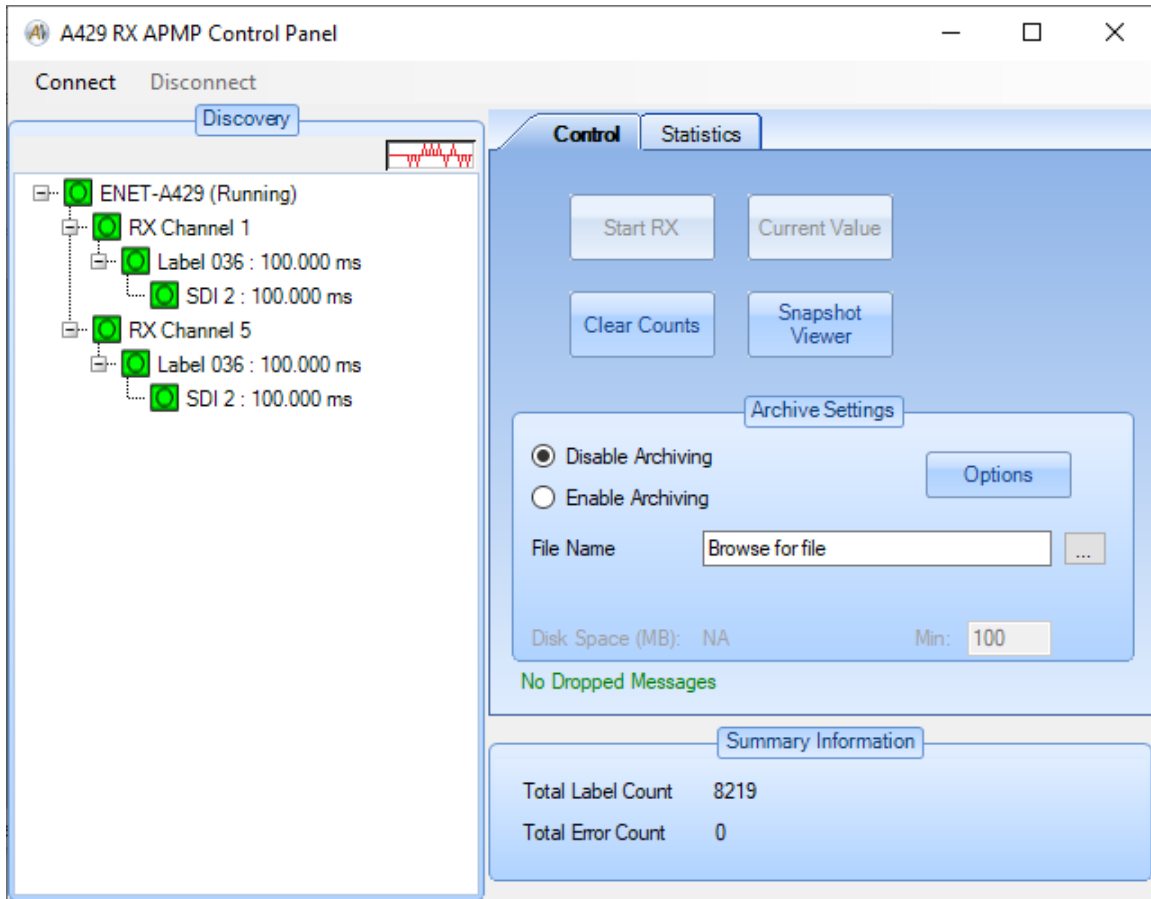

Chapter 3 – MIL-STD-1553 Tools

The “1553” tab on the ribbon-bar provides tools for the 1553 protocol.

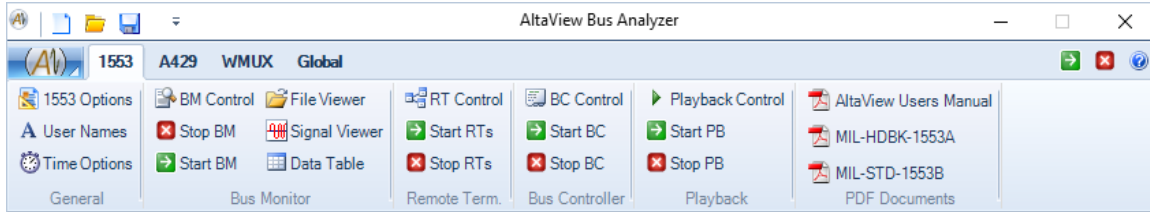

EBR1553 Operation

The *AltaView* 1553 tools can be used with the ENET-1553-EBR and MEZ-EBR devices for EBR1553 (10MBPS 1553 on RS485). The EBR devices are single function only so when opened the user is presented with a dialog to select whether to operate the device as a Bus Controller, Remote Terminal or Bus Monitor. Also with this dialog, the user can select whether to operate the EBR device in Link or Spec mode (see the EBR hardware manual for more information on Link and Spec modes). EBR1553 does not allow RTRT messages so the BC Control Panel disables the “Add RTRT” button. The Bus Monitor tools assume 1553 timing (1MBPS) for calculating intermessage gap time, status response time, and total message time, so these times are not accurate in EBR1553 mode (10MBPS). Intermessage gap times and status response times can be corrected by subtracting 1.8us. Total message time can be approximated by dividing by 10.

General Tools

The General tools provide basic things like 1553 protocol options, time options, and user-defined names. ***These tools are disabled if the device is not enabled for full analyzer operation.***

1553 Options

The “1553 Options” button will bring up the following dialog box:

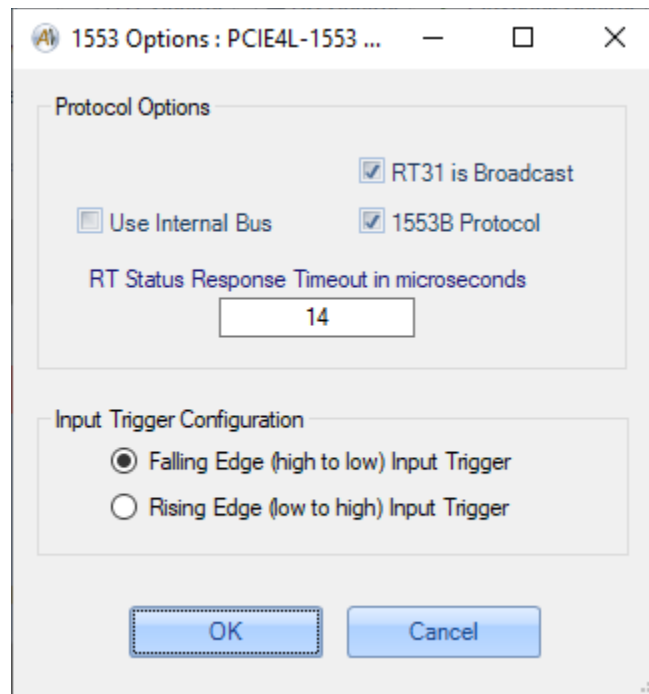

This allows you to customize the settings for the selected 1553 channel. The default values are shown here.

User Names

The “User Names” button will bring up the following dialog box:

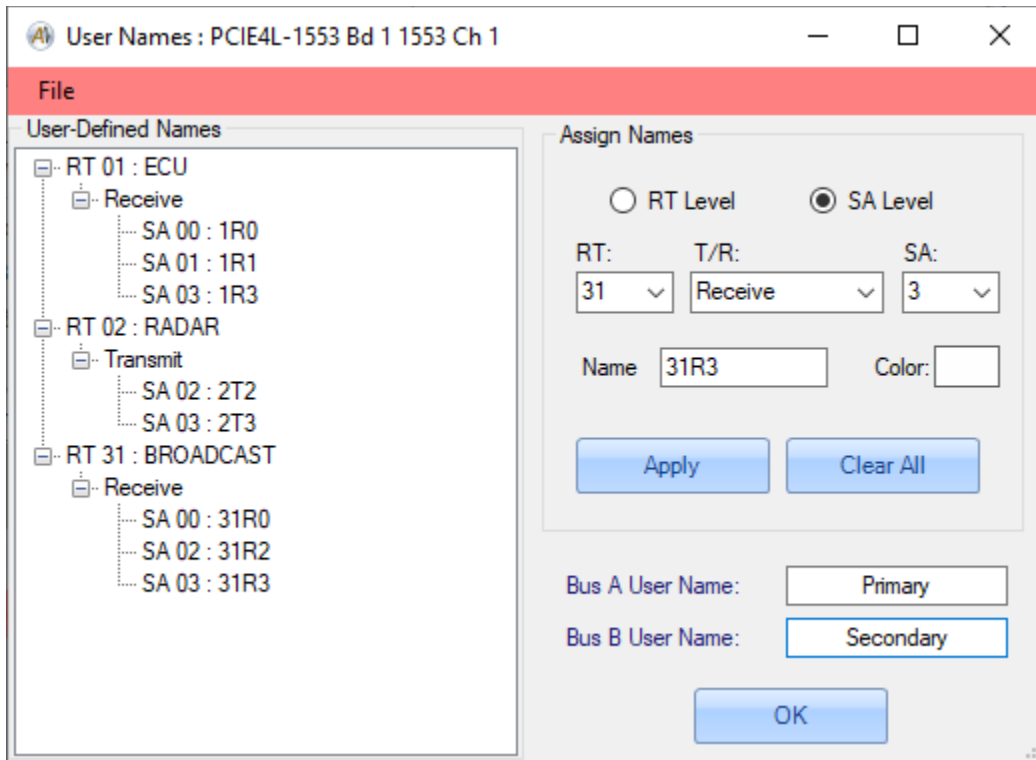

This allows you to define names at the Remote Terminal level or at the Sub-Address level. The “File” menu allows you to save or load files containing name definitions – these are XML files that are validated using the schema file “UserNames.xsd” or CSV files which can be selected with the “Save as type” of the save dialog.

Any defined names will be shown in the tree-view on the left side of the dialog box. In the example shown here, RT01 has been assigned the name “ECU”, RT02 has been assigned the name “RADAR”, RT02 Transmit SA03 has been assigned the name “2T3”, etc. Note that it is a good idea to keep the names as short as you reasonably can so that they will fit in the display area of the other controls and forms in *AltaView* that display the names. The Color field allows the specification of the color that will be used to display the message in the CDP Graphical Time Viewer.

You also have the option to assign a user name to Bus A and Bus B. These user names will appear in the BM Control Panel Discovery Tree.

Time Options

The “Time Options” button will bring up the following dialog box:

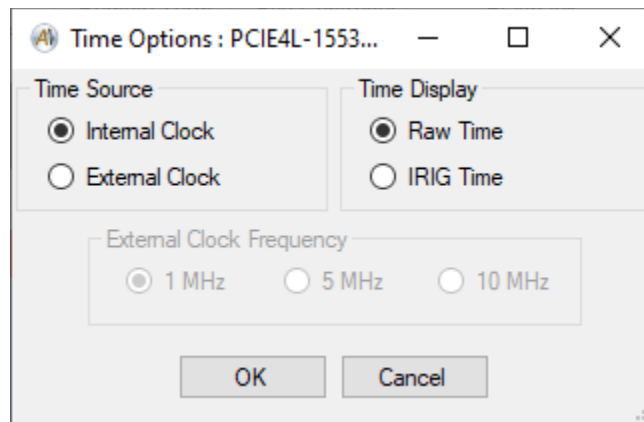

This allows you to select the time source (internal clock or external clock) and time display (raw or IRIG). If you select “External Clock” you must also select the frequency of the external clock (1MHz, 5MHz, or 10MHz). The “Internal Clock” always runs at 50MHz.

The selected clock source drives the BM time-tag registers and the Playback timer registers. Therefore if you wish to time synchronize the 1553 time-tag registers on multiple channels on the same card you must setup each channel to use the external clock. Refer to the section on “Playback Tools” for information on using the external clock for synchronous playback on multiple 1553 channels.

If “IRIG Time” is selected for Time Display, the 1553 BM will convert the internal time-stamp to the corresponding IRIG time as messages are read from the board. A good IRIG input signal must be connected to the board and the board must be calibrated for this signal. Refer to the section on the Board-Global Control Panel in Chapter 2 for more information on IRIG calibration.

NOTE: You must configure the external clock options at the board-global level before using the external clock at the channel level. Refer to Chapter 2 (General Tools) for more information on this.

Bus Monitor Tools

The Bus Monitor tools provide controls for BM operation. **For single-function devices the operator will be prompted to open the device in either Bus Monitor, Remote Terminal or Bus Controller mode. If BM mode is chosen, the Remote Terminal Tools and Bus Controller Tools are disabled and the device must be closed, then reopened to switch to RT or BC mode.**

BM Control

The “BM Control” button will bring up the BM Control Panel for the selected 1553 device. This is the main window for all Bus Monitor operations for the device. **If the device is not enabled for full analyzer operation, the Snapshot Viewer, Activity Viewer, message archiving, and trigger features are disabled.**

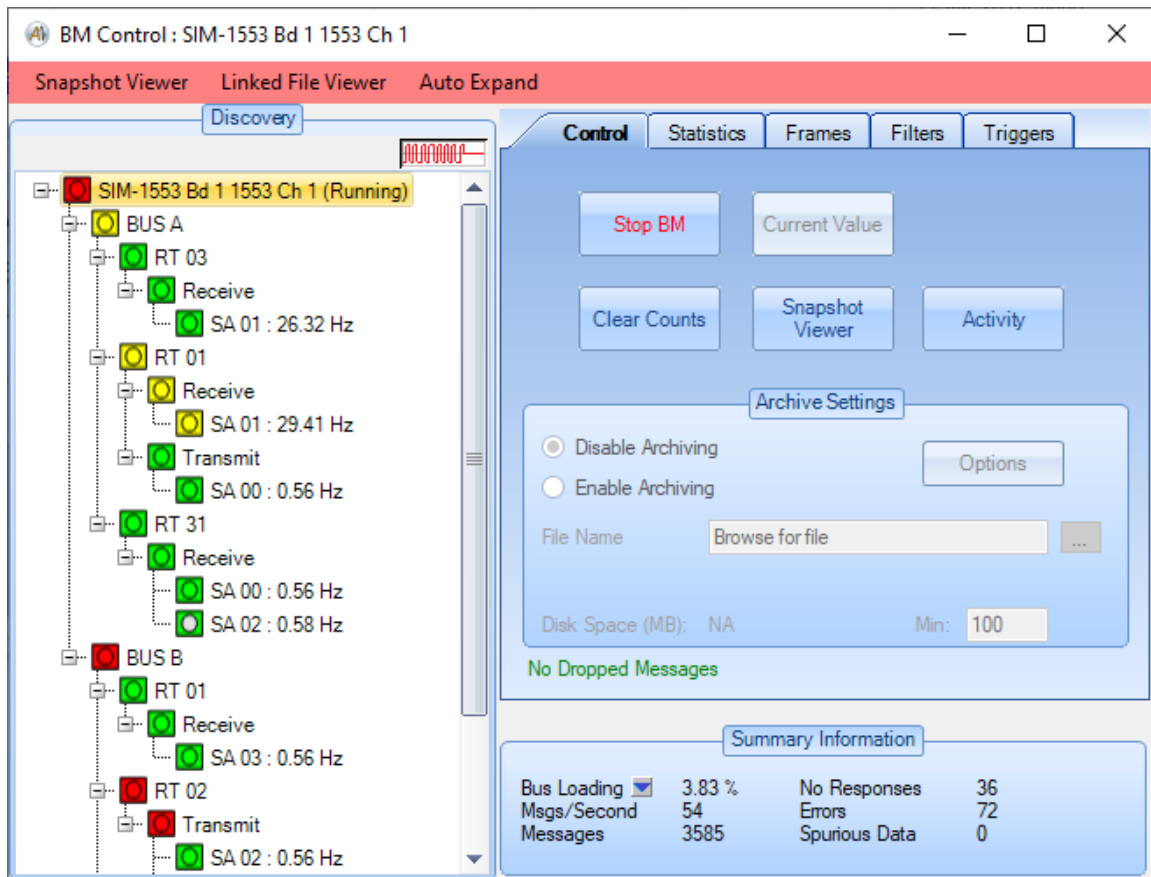

The BM Control Panel consists of the “Discovery” tree on the left and controls on the right. Summary information including bus loading and message counts is provided on the lower right.

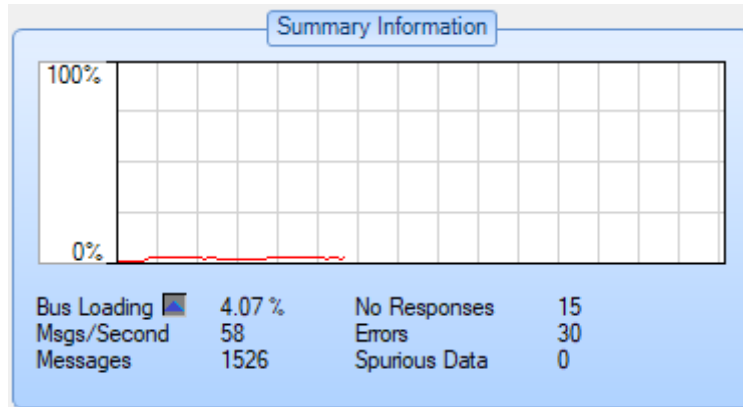

The small button with the triangle on it next to the “Bus Loading” text of the Summary Information area expands the region to show a graph of the bus loading percentage. The graph updates every half of a second and will auto scroll to show just over a minute of Bus Loading.

The discovery tree will populate itself as the bus monitor detects messages on the bus (if the bus monitor is running). The root of the tree is the 1553 Channel (device) and bus activity is represented by Bus, Remote Terminal, Transmit/Receive, and Sub-Address. If the user has defined names for RTs or SAs, then these names will also be displayed in the tree. Each node in the tree has an “activity icon”, which is a square with a circle inside of it. The square represents past conditions and the circle represents the current condition. There are four colors representing possible conditions:

- Gray = No Activity
- Green = Activity with no errors
- Yellow = Activity with no status response from the RT
- Red = Activity with protocol errors (parity, gap, etc.)

For example, if the activity icon is Red in the square and Green in the circle, this indicates that there was a protocol error sometime in the past but most recent activity had no errors.

Sub-Address nodes display message frequency in Hz, based on the time period since the previous message for the Sub-Address.

1553 BM Error Codes

The 1553 BM tools will report any errors detected in the messages. This is derived from the error flags in the CDP Status Word for each message. The following table lists the error codes you may see:

Error Code	Description
SYNC	A sync error was detected – a command sync was seen when a data sync was expected (or vice-versa).
BITCNT	A bit-count error was detected – could be too few bits or too many bits in a word. This error can be caused by a Manchester encoding error (zero-crossing in the wrong place). It can also be caused by bus collisions (two terminals transmitting at the same time).
PARITY	A parity error was detected – 1553 expects to see odd parity on every word. A bit/encoding error can also cause parity errors.
WDCNT	A word count error was detected – this could be too few or too many words in the message.
NORESP	A no-response error was detected – a command was sent to the RT but the RT did not respond with a status word within the allowed time (typically 14us is allowed, RT should respond within 4-12us).
WRONG-RT	A wrong RT address error was detected. An RT responded to the command but the RT status word contained the wrong RT address.
TWO-BUS	A two-bus error was detected – activity was detected on Bus A and Bus B simultaneously. 1553 is “dual standby redundant”, which means only one of the two busses can be active at a given time.
SPURIOUS DATA	If the BM sees unexpected data on the bus it will report spurious data . For example, if a command word is sent with a sync error (data sync rather than command sync) then it looks like data sent without a command word and is seen as spurious data.

BM Linked File Viewer

You can open a **BM Linked File Viewer** by clicking the “Linked File Viewer” menu-strip item. This opens an instance of the BM File Viewer that is “linked” to this 1553 device.

If the BM is NOT RUNNING for the device, then as you move through a CDP file in the Linked File Viewer the messages are fed into the BM to drive the displays. Therefore you can single-step through messages in the viewer and the discovery

tree will populate, the statistics counters will increment, the current value viewers will update, and the Data Table will update. Note that you can move forward or backward in the file and every time you move in the file viewer the current message (first message in the file viewer display) is fed into the BM, therefore if you move back and forth you can count the same message multiple times so the statistics counts could be thrown off by this.

If the BM for the device IS RUNNING, then the Linked File Viewer does NOT feed messages into the BM to drive the displays – the live BM drives the displays in this case.

BM Discovery Tree

The BM Discovery Tree shows all detected bus activity by Bus, RT address, Transmit/Receive, and Subaddress. By default the tree will auto expand to the RT level. The menu-strip selection “Auto Expand” allows you to select RT level or SA level. The tree is cleared and repopulated if you stop and restart the BM or if you click the “Clear Counts” button – the tree will then auto expand to the selected level. Changing the auto expand setting while running clears counts and redraws the tree with the new setting.

The discovery tree can be reorganized by the user. You can right-click on any node and select the options to “Move Up”, “Move Down”, or “Expand All”. The “Expand All” selection will expand all nodes below the node you right-clicked on.

The screenshot displays the BM Control software interface. The window title is "BM Control : SIM-1553 Bd 1 1553 Ch 1". The interface is divided into several sections:

- Discovery Tree (Left):** A hierarchical tree view showing bus activity. The root node is "SIM-1553 Bd 1 1553 Ch 1 (Running)". It branches into "BUS A" and "BUS B". Under "BUS A", there are "RT 03" (Receive) and "RT 01" (Receive). "RT 03" has a sub-address "SA 01 : 27 00 Hz". "RT 01" has sub-addresses "SA 01 : 27 00 Hz" and "SA 00 : 0.57 Hz". Under "BUS B", there are "RT 31" (Receive) and "RT 02" (Transmit). "RT 31" has sub-addresses "SA 00 : 0.57 Hz" and "SA 02 : 0.56 Hz". "RT 02" has sub-addresses "SA 03 : 0.58 Hz" and "SA 02 : 0.57 Hz".
- Control Panel (Right):** A panel with tabs for "Control", "Statistics", "Frames", "Filters", and "Triggers". The "Control" tab is active, showing buttons for "Stop BM", "Current Value", "Clear Counts", "Snapshot Viewer", and "Activity". There is also an "Archive Settings" section with "Disable Archiving" and "Enable Archiving" radio buttons, a "File Name" field with a "Browse for file" button, and a "Disk Space (MB)" field showing "NA" and "Min: 100". A "Summary Information" section at the bottom right displays:

Summary Information			
Bus Loading	3.75 %	No Responses	139
Msgs/Second	62	Errors	278
Messages	13961	Spurious Data	0

At the SA level, you can also select “View Current Value” to see the most recent message for that SA. This is identical to clicking the “Current Value” button in the “Control” tab. If you double-click on an SA node this will bring up the “Current Value” viewer for that SA.

NOTE – The “Current Value” shows the **most recent message for the selected SA**. This does not differentiate between Bus A or Bus B – just as a 1553 Remote Terminal does not differentiate between data on Bus A or Bus B. If you have messages to the same RT/TR/SA on both Bus A and Bus B then the Current Value viewer will show the most recent message for that RT/TR/SA on either bus.

Control Tab

The BM controls consist of tabs for Control, Statistics, Frames, Filters, and Triggers. The “Control” tab is shown here:

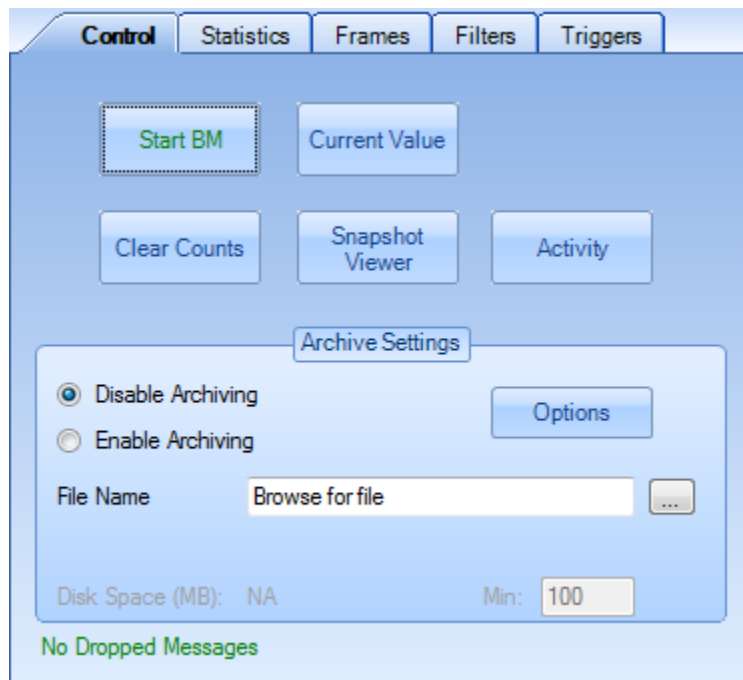

The “Start BM” button starts the bus monitor. When the BM is running, this changes to a “Stop BM” button. A text label below the Archive Settings panel indicates whether or not the BM has dropped any messages. Every message contains a “sequence number” which should increment by one on every message. If the BM sees a message that does not have the expected sequence number then it will indicate that messages have been dropped. Note that this sequence number is displayed as “Message Number” in the various BM views.

When the BM is not running the “Archive Settings” panel is enabled. You can enable or disable archiving to record messages to a data file, and of course you can specify the file name to store the messages to. If archiving is enabled and a

valid file/path has been selected, the available disk space (in MB) is displayed. You can specify the minimum free disk space to preserve – if **AltaView** detects that the free disk space has dropped below the minimum value it will stop the bus monitor. The minimum free disk space defaults to 100 MB.

The “Options” button provides a dialog box where you can specify the desired archiving options.

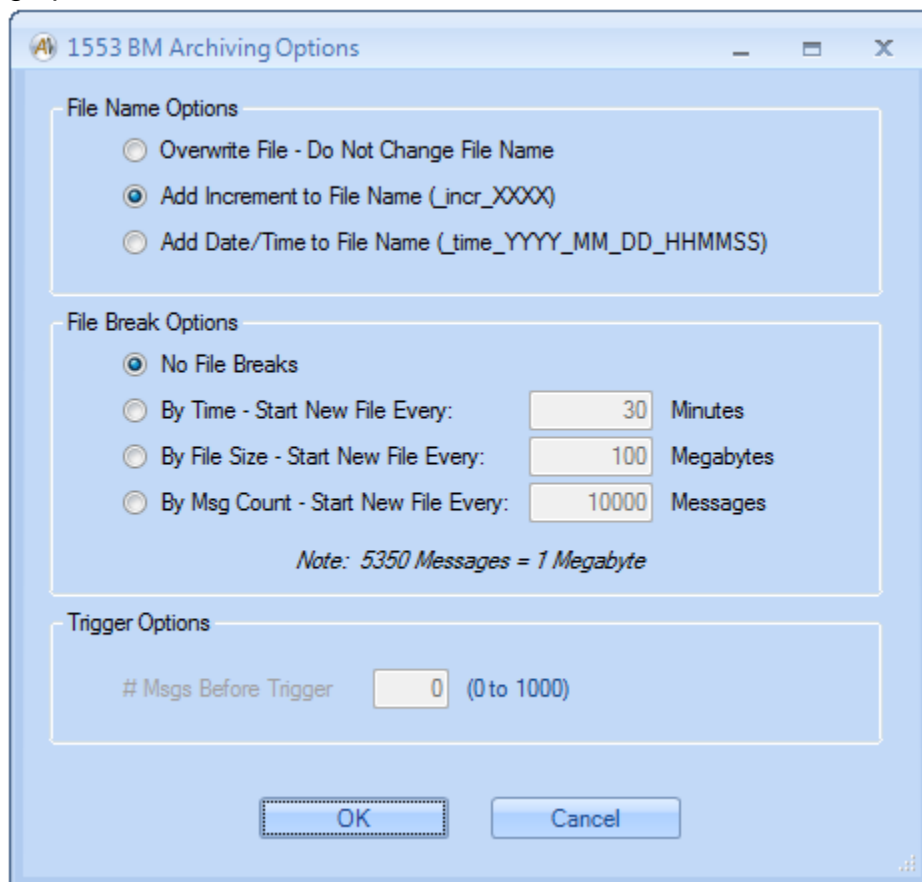

Under File Name Options, the option to “Add Increment to File Name” is selected by default – this prevents you from accidentally overwriting an existing file. If you do want to overwrite the file if it exists, you can use the “Overwrite File” option. You also have the option to add a date/time to the file name rather than an incrementing number.

The File Break Options allow you to specify the condition to close one archive file and open a new one. Note that you cannot do this if “Overwrite File” is selected. You can start a new file based on time in minutes, file size in megabytes, or number of messages.

If a trigger is enabled (in the “Triggers” tab) you will have the option to record up to 1000 messages before the trigger message. For example, if you are triggering on an error you can use this to capture the messages leading up to the message where the error occurred.

If you enable archiving and start the BM, you will see an archiving indicator at the top of the Discovery panel (left of the “running” indicator) as shown here:

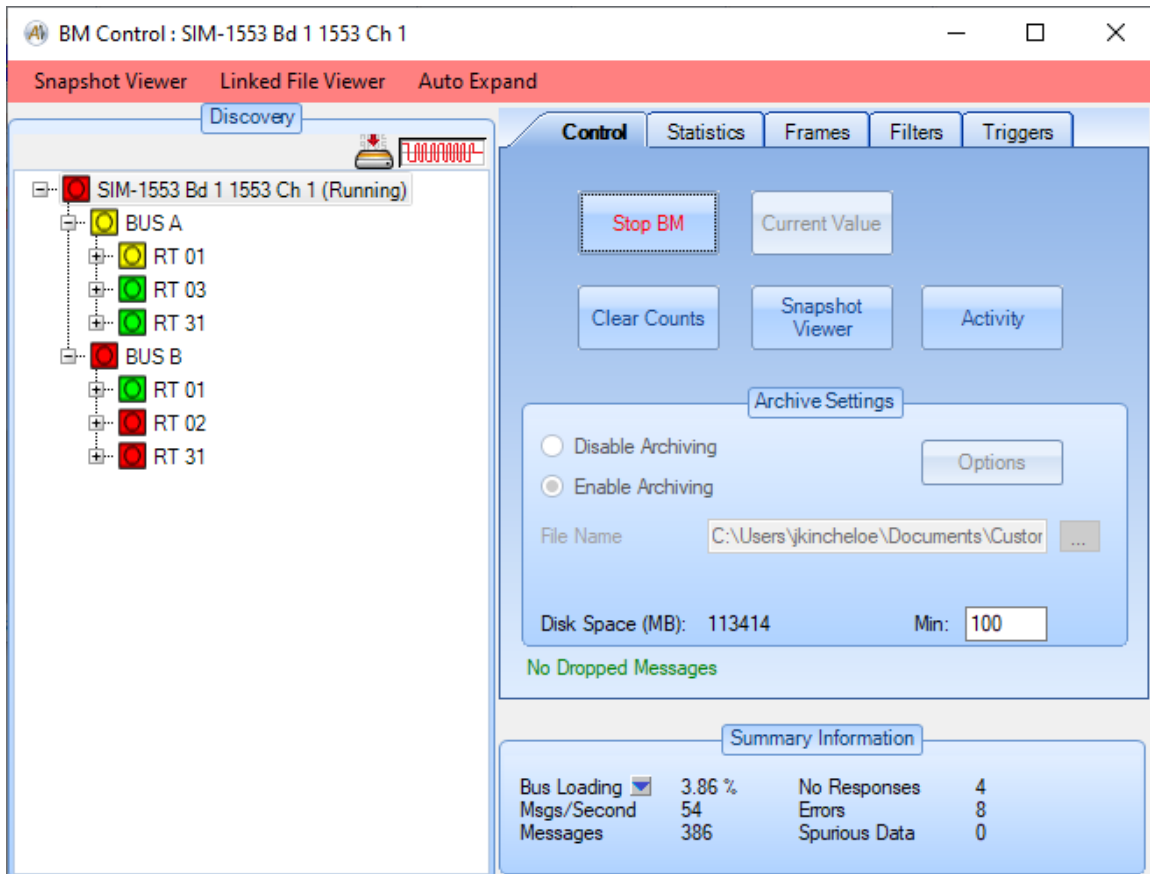

If you have enabled a BM Trigger, then the archiving indicator will not appear until the trigger event occurs and the BM starts recording messages to file. Note that BM triggers only apply for archiving to file – the trigger does not affect the discovery tree, snapshot viewer, activity viewer, etc.

The “Clear Counts” button zeroes the message counters and clears the discovery tree. This can be useful if you want to clear any past conditions. The BM state is automatically cleared when the BM is started so old message counts etc. will not carry over to a new run of the BM.

BM Current Value Viewer

If a SA level node is selected in the discovery tree, then the “Current Value” button will be enabled. Either the “Current Value” button or the right-click option “View Current Value” will display the current value view for the selected SA.

NOTE – The “Current Value” shows the **most recent message for the selected SA**. This does not differentiate between Bus A or Bus B – just as a 1553 Remote Terminal does not differentiate between data on Bus A or Bus B. If you have messages to the same RT/TR/SA on both Bus A and Bus B then the Current Value viewer will show the most recent message for that RT/TR/SA on either bus.

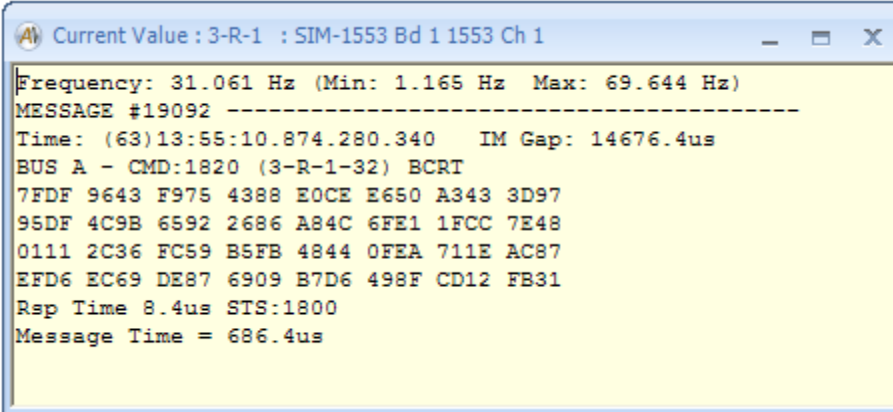

```
Current Value : 3-R-1 : SIM-1553 Bd 1 1553 Ch 1
Frequency: 31.061 Hz (Min: 1.165 Hz Max: 69.644 Hz)
MESSAGE #19092 -----
Time: (63)13:55:10.874.280.340 IM Gap: 14676.4us
BUS A - CMD:1820 (3-R-1-32) BCRT
7FDF 9643 F975 4388 E0CE E650 A343 3D97
95DF 4C9B 6592 2686 A84C 6FE1 1FCC 7E48
0111 2C36 FC59 B5FB 4844 0FEA 711E AC87
EFD6 EC69 DE87 6909 B7D6 498F CD12 FB31
Rsp Time 8.4us STS:1800
Message Time = 686.4us
```

Note that the Current Value display shows frequency information as well as the most recent message. The first line shows the current frequency (determined from the period between the last two messages for this SA), the minimum frequency, and the maximum frequency. This can be very useful for verifying that messages occur at the rates they are supposed to as defined for the system.

BM Snapshot Viewer

The “Snapshot Viewer” button allows you to examine a snapshot of up to 1000 messages from BM memory. The BM Snapshot Viewer is shown below:

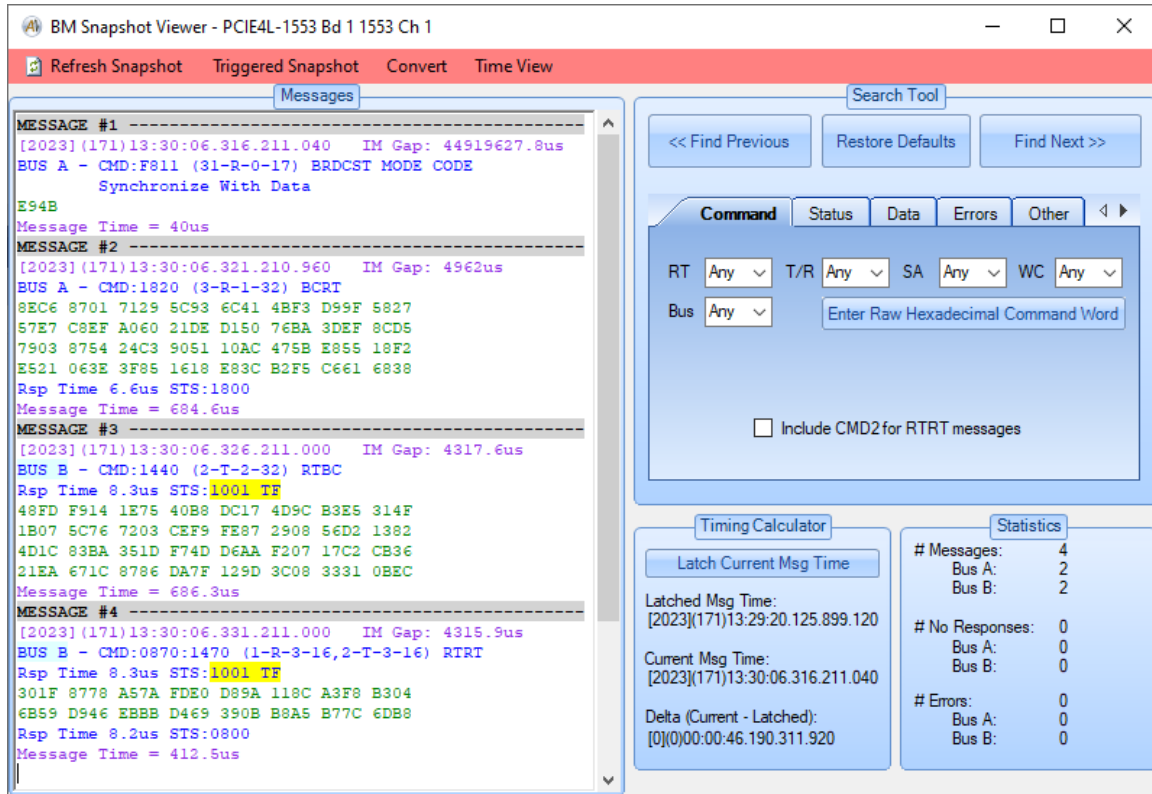

A menu-strip provides the following options:

“Refresh Snapshot” – Will update the display with the current messages in the BM Snapshot Buffer (up to 1000 messages). These are the most recent messages seen by the BM. The messages are displayed on the left in a scrollable window.

“Triggered Snapshot” – This displays the contents of the Trigger Buffer rather than the Snapshot Buffer (up to 1000 messages). These are the messages associated with the most recent trigger event, as defined in the Trigger tab of the BM Control Panel. If there has been no trigger event then no messages are displayed. You can update the trigger buffer display by clicking the “Triggered Snapshot” menu-strip item again. Note that the trigger does not “re-arm” unless you stop the BM and start it again. Therefore the trigger buffer will show messages from the trigger event. If you want to re-arm the trigger to capture a new event you must stop the BM and start it again.

“Convert” – Provides a pull-down menu with file conversion options. The available options are:

“To ASCII” – write messages to an ASCII text file. ASCII text files can be viewed by any text editor.

“To CSV” – write messages to a CSV (Comma-Separated Values) file. CSV files can be viewed by spreadsheet applications like Microsoft Excel. This format writes one message per row with columns for Timestamp, IM Gap, CMD1, CMD2, STS1, STS2, Data words 1-32, and CDP Status Word. You have the option to write numbers in Hexadecimal or Decimal format. Microsoft Excel will treat Hexadecimal values as text strings, therefore if you need to do numerical processing on the data you should use Decimal format.

“To CDP (binary)” – write messages to a binary CDP file. CDP files can be viewed by the *AltaView* BM File Viewer.

All of these options will give you a dialog box similar to the one shown below:

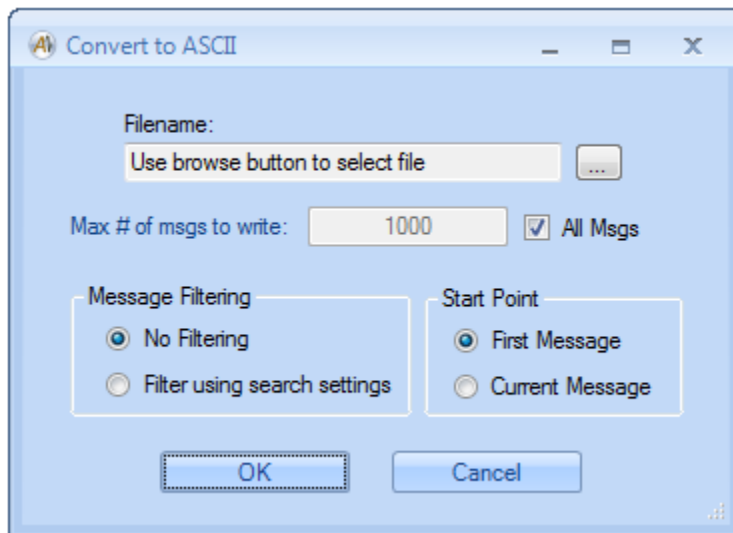

A browse button is provided to the right of the filename field – this is used to select a file or provide a filename for a new file to store the messages. You can specify a maximum number of messages to write to the file. You have the option to filter messages using the search settings – if this is selected then only those messages that match the conditions defined in the Search Tool will be written to the file. You can also start from either the first message or from the current

position in the display (starts with the message at the top of the “Messages” window).

“**Time View**” – Opens the BM Time View window. This window is discussed in the “BM Time View” section below.

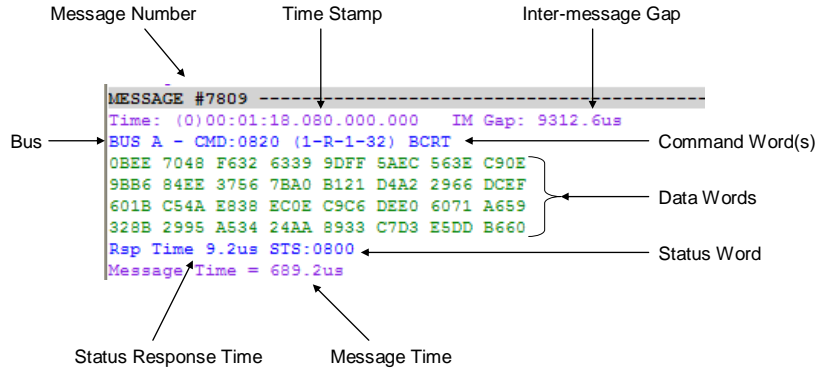

The message display shows time-stamp and gap information in magenta, command and status information in blue, and data information in green, as shown above. Any errors are shown in red and highlighted in yellow.

On the right side of the Snapshot Viewer you have a Search Tool, a Timing Calculator, and a Statistics panel.

The Statistics panel provides basic counts for the current set of messages in the snapshot – number of messages, no-responses, and errors by bus (A or B).

The Timing Calculator is used to measure the time difference from one message to another. The first (top) message displayed in the “Messages” panel is the current message – you will see that the Timing Calculator always displays the “Current Msg Time” as the timestamp of the first message in the “Messages” panel. If you click on the button to “Latch Current Msg Time” the Timing Calculator will save the timestamp of the current message as the “Latched Msg Time”. Now as you move through the messages the “Current Msg Time” will change and the Timing Calculator will update the “Delta (Current – Latched)”

time. As the name indicates, this delta time is the result from subtracting the latched time from the current time. Negative delta times are shown in red.

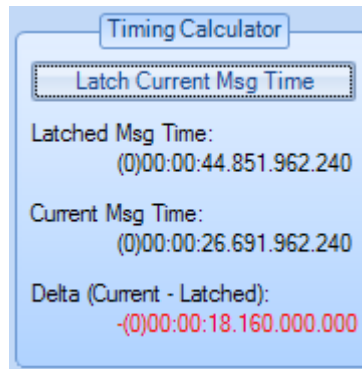

Note that the “Latched” message is shown with a dark yellow background for the message number line in the message display.

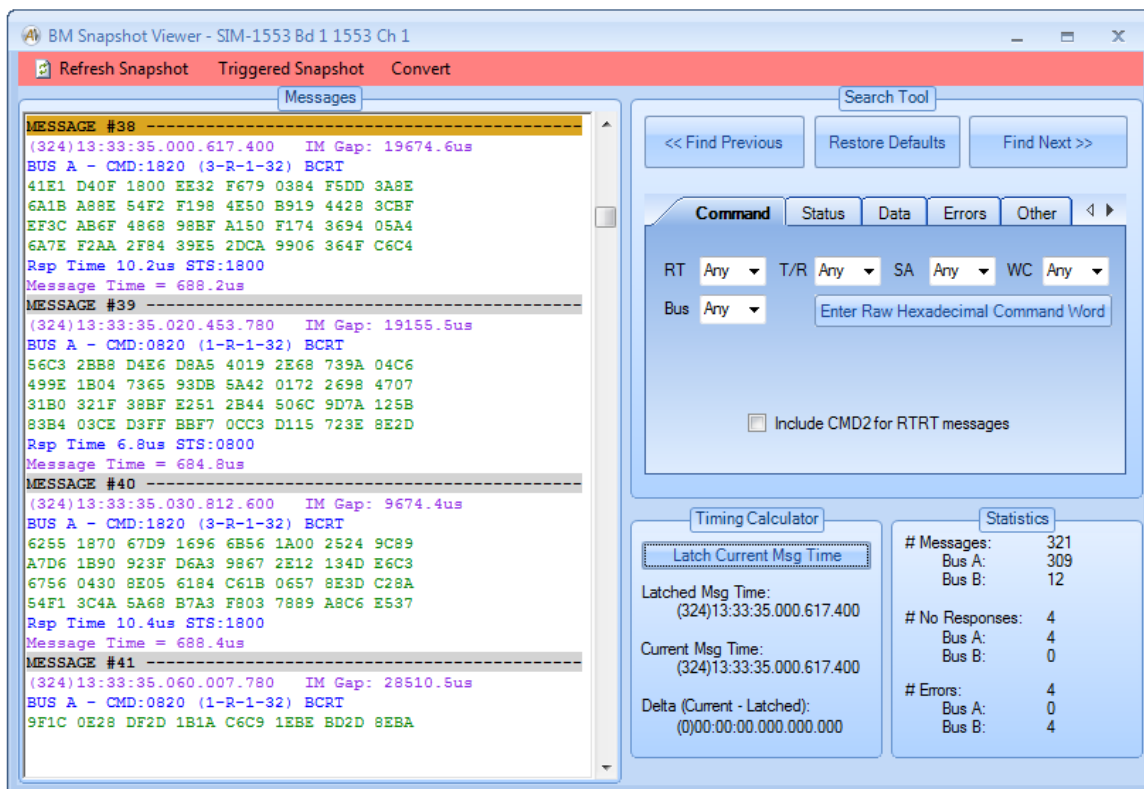

The Search Tool is a very powerful utility to find specific messages and conditions. This tool lets you specify search criterion in command words, status words, data words, errors, and/or a combination of them. You can search forward or backward from the current message.

For example, let's say we want to find messages for RT 01 receive on Bus B with the Service Request bit set in the status word and a value of hexadecimal ABCD in the first data word.

Under the "Command" tab, we would select Bus B, RT 1, and T/R of 0 (receive).

The screenshot shows the 'Command' tab of a software interface. It features several dropdown menus: 'RT' set to '1', 'T/R' set to '0', 'SA' set to 'Any', and 'WC' set to 'Any'. The 'Bus' dropdown is set to 'B'. Below these is a text input field labeled 'Enter Raw Hexadecimal Command Word'. At the bottom, there is a checkbox labeled 'Include CMD2 for RTRT messages' which is currently unchecked.

Under the "Status" tab, we would select SR = 1.

The screenshot shows the 'Status' tab of the same software interface. It features a grid of dropdown menus: 'RT' (Any), 'ME' (Any), 'IN' (Any), 'SR' (1), 'R7' (Any), 'R6' (Any), 'R5' (Any), 'BCR' (Any), 'BUSY' (Any), 'SF' (Any), 'DBCA' (Any), and 'TF' (Any). At the bottom, there is a checkbox labeled 'Include STS2 for RTRT messages' which is currently unchecked.

Under the “Data” tab, we would select word index 1 for the first data word, AND mask of FFFF to look at the entire word, a Comparison of “>=”, and a Value of 8000. The software will fetch word 1, perform a bitwise AND operation with the mask, then compare to the value using the selected comparison operation. The available comparison operations are:

- “=” Equal To (default)
- “!=” Not Equal To
- “>” Greater Than
- “>=” Greater Than or Equal To
- “<” Less Than
- “<=” Less Than or Equal To

The screenshot shows a configuration panel with five tabs: Command, Status, Data, Errors, and Other. The 'Data' tab is selected. It contains four fields: 'Word' with a dropdown menu set to '1', 'AND Mask' with a text input field containing 'FFFF', 'Comparison' with a dropdown menu set to '>=', and 'Value' with a text input field containing '8000'.

Now we can use the “Find Previous” button to search backward or the “Find Next” button to search forward in the message buffer.

The screenshot shows a 'Search Tool' window. At the top, there are three buttons: '<< Find Previous', 'Restore Defaults', and 'Find Next >>'. Below these buttons is a configuration panel identical to the one in the previous image, with the 'Data' tab selected and the same settings: Word: 1, AND Mask: FFFF, Comparison: >=, and Value: 8000.

If no message exists that meets the search criterion, then a message box will pop up to tell us that the message was not found.

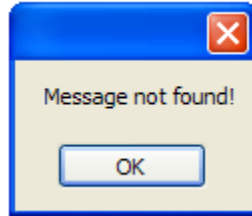

If we want to define a new search we can use the “Reset Defaults” button so we don’t have to remember and un-do the last set of search parameters. The default search settings will find any message.

Note that the last message found by the search tool is shown with a light blue background for the message number line in the message display.

BM Snapshot Viewer - PCIe4L-1553 Bd 1 1553 Ch 1

Refresh Snapshot Triggered Snapshot Convert Time View Histogram

Messages

Search Tool

<< Find Previous Restore Defaults Find Next >>

Command Status Data Errors Other

RT Any T/R Any SA Any WC Any

Bus Any Enter Raw Hexadecimal Command Word

Include CMD2 for RTRT messages

Timing Calculator

Latch Current Msg Time

Latched Msg Time:
(1)00:00:00.000.000.000

Current Msg Time:
[2024](201)14:55:22.277.023.780

Delta (Current - Latched):
[24](200)14:55:22.277.023.780

Statistics

Messages: 1000
Bus A: 766
Bus B: 234

No Responses: 295
Bus A: 236
Bus B: 59

Errors: 175
Bus A: 59
Bus B: 116

BM Time View

The “Time View” option on the BM Snapshot Viewer window opens a new window which displays the Snapshot messages in a graphical manner. A menu-strip provides the following options:

“**Convert**” – Provides a pull-down menu with file conversion options. The available options are:

“To ASCII” – write messages to an ASCII text file. ASCII text files can be viewed by any text editor.

“To CSV” – write messages to a CSV (Comma-Separated Values) file. CSV files can be viewed by spreadsheet applications like Microsoft Excel. This format writes one message per row with columns for Timestamp, IM Gap, CMD1, CMD2, STS1, STS2, Data words 1-32, and CDP Status Word. You have the option to write numbers in Hexadecimal or Decimal format. Microsoft Excel will treat Hexadecimal values as text strings, therefore if you need to do numerical processing on the data you should use Decimal format.

“To CDP (binary)” – write messages to a binary CDP file. CDP files can be viewed by the *AltaView* BM File Viewer.

All of these options will give you a dialog box similar to the one shown below:

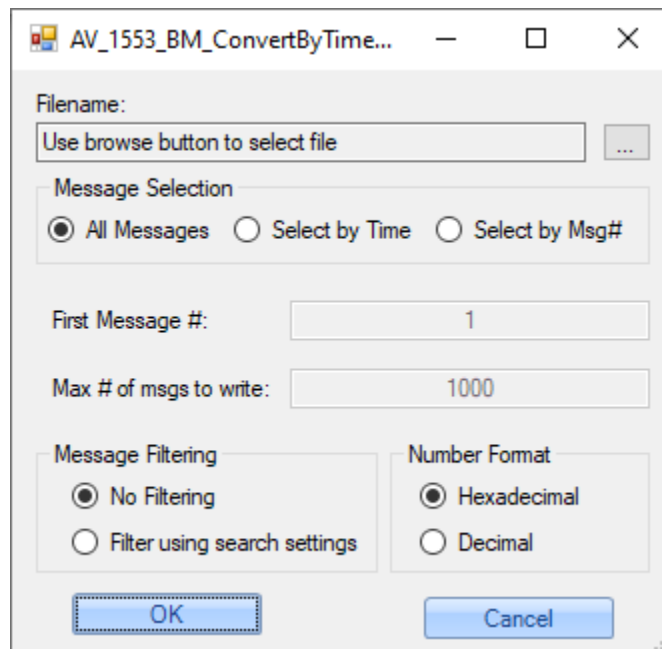

A browse button is provided to the right of the filename field – this is used to select a file or provide a filename for a new file to store the messages. A set of radio buttons allows you to choose all of the messages in the file or to select a subset of messages specified by a start and end time or by a start message number and a total number of messages to include in the converted file. You have the option to filter messages using the search settings – if this is selected then only those messages that match the conditions defined in the Search Tool will be written to the file. Lastly if converting to a CSV format you can select whether the data format will be hexadecimal or decimal values.

“Settings” – Provides a pull-down menu with the following options:

“Link with BM 1553 Data Viewer” [Check Option] – when the viewer is opened it is linked to the parent Snapshot Viewer window so if the user uses the vertical scroll bar on the Snapshot Viewer to change the starting message the Graphical Viewer will change to place the same starting message at the beginning of the Message Display Area. Also, if the beginning message of the Graphical Viewer is changed then the Snapshot viewer will also display that same message as well. Unchecking this option allows the two windows to scroll through the data independently.

“Show Search Tool” [Check Option] – This option will be disabled when the Graphical Viewer is linked to the Snapshot Viewer window as it will react to the Search Tool of the Snapshot Viewer. When unlinked the user can select this option to show the Search Tool, identical to the one on the Snapshot Viewer to find messages. This tool will appear on the right side of the Graphical Viewer, see the Snapshot Viewer Search Tool above on its use.

“Message Colors” – Choosing this opens a dialog that allows the user to select the color used to display the different message types in the Message Display region of this dialog.

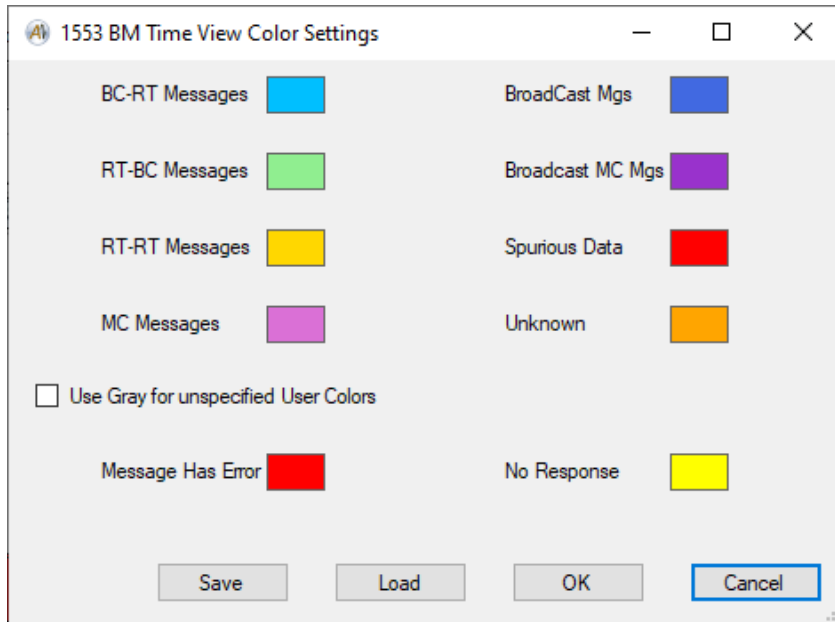

Clicking on one of the color rectangles opens a color select dialog allowing the user to choose the color for the message. The “Use Gray for unspecified User Colors” will make all messages gray that don’t have a color selected in the Users Name dialog from the Main AltaView screen.

The “Message Has Error” and “No Response” colors are used for the frames of the message.

The user may save these color selects to an XML file or load previously defined values from a saved file.

“Save Image” – Provides a pull-down menu with a single option:

“To Image File” – Selecting this will bring up a file save dialog which will save the Graphical Viewer display to an Image file. The filter option of the dialog can be used to save the image as either a JPEG, PNG or GIF file format.

“Load Conversions” – The user can load data conversion information from an XML which was saved from the “Data Table” dialog of AltaView. Message data that has conversions specified for it will have the converted data displayed in

black text above with the raw data for the 1553 message when hovered over in the Message Display Area.

```
Message #158527  
[2023] (314) 15:29:18.612.203.780 IM Gap:10.5µs  
BUS A - CMD: 1070:1C90 (2-R-3-16,3-T-4-16) RTRT  
Rsp Time 6.5us STS: 1800  
Longitude:133.12 Deg  
Latitude:12.81 Degrees  
3400 3401 0501 0501 3404 3405 3406 3407  
3408 3409 340A 340B 340C 340D 340E 340F  
Rsp Time 6.5us STS: 1000  
Message Time = 409us
```

**Example of
Converted Data**

The BM Time View windows has three sections:

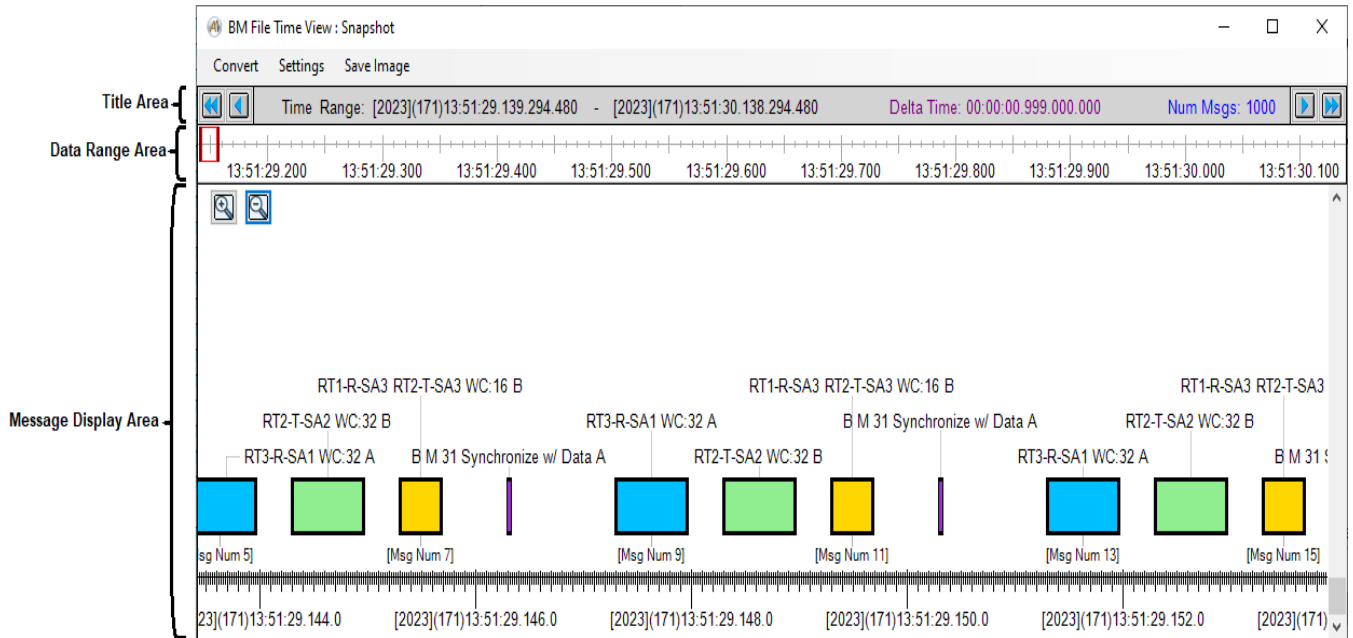

The top section is the “Title Area” which is a small light gray bar that has the time of the first and last messages in black text followed by the time difference between those two messages. The last text in blue is the total number of 1553 messages in the data being displayed. Also, there are four buttons for scrolling through the messages in the “Message Display Area”. These are as follows:

 Scroll the view 10 messages to the left.

 Scroll the view 1 message to the left.

 Scroll the view 1 message to the right.

 Scroll the view 10 messages to the right.

The middle section, just below the “Title Area” is the “Data Range Area”. This rectangular area represents the entire time of the data set. A red rectangular frame indicates the position of the current view area for the “Message Display Area”. The width of this indicator is proportional to the total view area of the data set shown in the “Message Display Area”. It will change width with the zooming in and out to coincide with the change in viewable area.





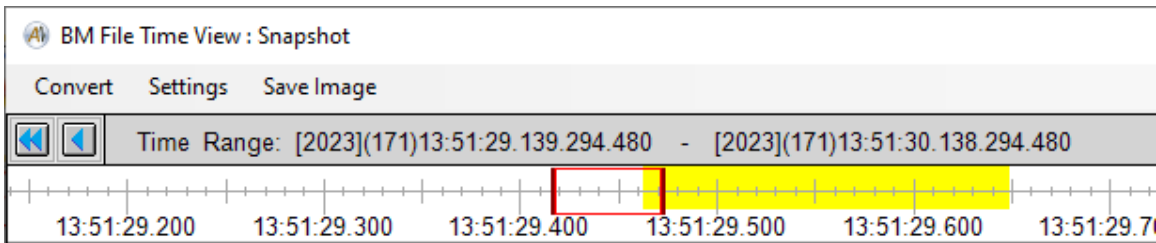

Left-clicking in the “Data Range Area” will move the location of the “Message Display Area”, so this can be used to navigate through the data viewed.

Right-clicking in the “Data Range Area” and then moving the mouse left or right while holding down the right mouse button will cause a highlighted yellow rectangle to appear as shown below.



If a Convert option is then selected the convert dialog will use the highlighted area to fill in the start and end times for the data to convert. If the Control button is held down when first right-clicking it will also move the red location indicator to the clicked-on point.

The final section of the display is the Message Display Area. It shows the 1553 messages on a horizontal time axis with various colored rectangles with length proportional to the time of the entire message. The following colors are used for the different message types:

	BC-RT messages : Blue
	RT-BC messages : Light Green
	RT-RT messages : Yellow
	Mode Code messages : Light Purple
	Broadcast Mode Code messages : Dark Purple
	Broadcast messages : Dark Blue
	Spurious Data : Red

If a message has an error, then the middle line of the frame will be red as well as having the original message color for the interior of the rectangle:



BC-RT message with error.

Note that these colors are the default and can be changed using the “Settings” > “Message Colors” option of the dialog discussed above.

Summary text will be displayed within the message rectangle if it is wide enough to accommodate it, otherwise the text will be shown above the message rectangle with a line connecting it. The labels will indicate the Remote Terminal (RT), Receive/Transmit mode (R/T), SubAddress (SA) and Word Count (WC) and will be followed by either an ‘A’ or ‘B’ indicating which bus the message was transmitted on. Mode Codes have a different format, there will be an ‘M’ character followed by the RT number and then a text description of the Mode Code value. A leading ‘B’ character on the label indicates that the message is a Broadcast message. Below a message text may be displayed indicating the message number, note this is the ordinal message number from the start of the data, not the internal message number recorded by the Bus Monitor.

Hovering the mouse cursor in a message rectangle causes an information box to appear that shows the same information of the message as displayed in the Snapshot Viewer:

```

Message #1103
[2023] (173) 13:21:30.560.335.900 IM Gap:317.6ps
BUS B - CMD: 1440 (2-T-2-32) RTBC
Rsp Time 8.2us STS: 1001 IN TE
48FD F914 1E75 40B8 DC17 4D9C B3E5 314F
1B07 5C76 7203 CEF9 FE87 2908 56D2 1382
4D1C 83BA 351D F74D D6AA F207 17C2 CB36
21EA 671C 8786 DA7F 129D 3C08 3331 0BEC
Message Time = 686.2us
  
```

RT2-T-SA2 WC:32 B



[Msg Num 39]

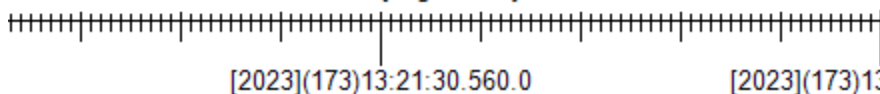

Two buttons in the upper lefthand corner of the Message Display Area allow the user to zoom in and out along the time axis. The highest resolution is 1µs per pixel width and the lowest resolution is 1 milli second per pixel width. The user can also zoom in and out by holding the Ctrl key down and scrolling the mouse wheel.

The user can also left-click in the Message Display area and while holding the left mouse button down scroll the view left and right to navigate through the data.

BM Histogram

The “Histogram” option on the BM Snapshot Viewer window opens a new window which displays a histogram of the messages in the BM buffer (it is available in the File Viewer and uses all messages in a file).

Messages for each RT are displayed within their own graph similar to the dialog below.

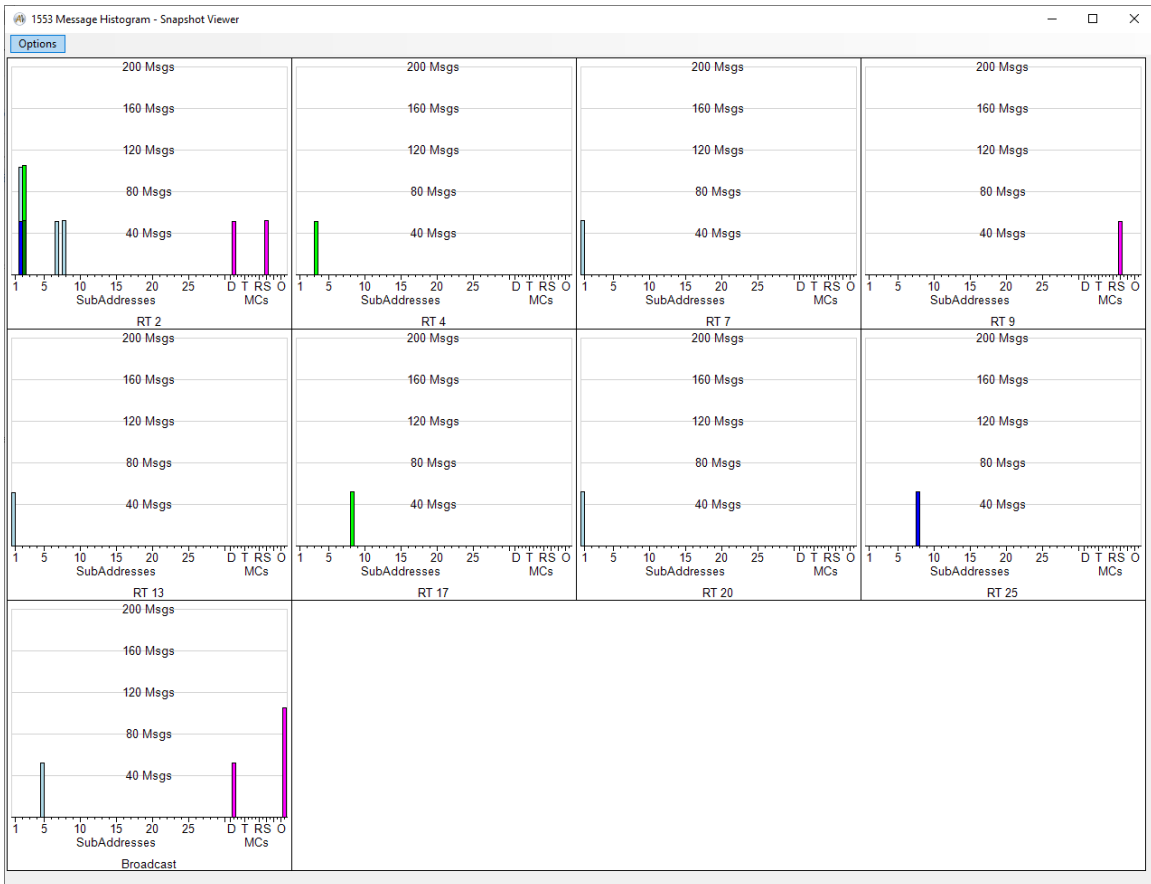

Each Remote Terminal graph displays a count of the messages broken out by subaddress and mode code. The Image below is the Remote Terminal 2 graph from above. The information is as follows:

1. The Remote Terminal (RT) number is displayed at the bottom of the graph. By default, only RTs that have messages associated with them are displayed. Under Options menu there is a "Show Empty RTs" selection which will display all 32 RTs regardless of whether they have messages or not, they will appear without any data.
2. The left side of the axis represents the SubAddress messages, subaddresses are 1 through 30 (0 and 31 being reserved for Mode Codes). Note the bars straddle the tick marks, this is because the bars to left side of the tick mark represent Receive messages while those on the right side represent Transmit messages. Also the bars may be split vertically, this split is represented by the lower, darker color being messages from Bus A and upper, lighter colors being from Bus B. In the example below for SubAddress 2 the bars indicate approximately 50 Receive messages on Bus A (Dark Blue) and about the same number on Bus B (Cyan). Then there are about 50 Transmit messages on Bus A (Dark Green) and another 50 on Bus B (Light Green). The two cyan bars to the right represent about 50 Bus B messages for both RT 7 and RT 8.
3. The Right side shows Magenta bars that represent the Mode Code Messages for the Remote Terminal.

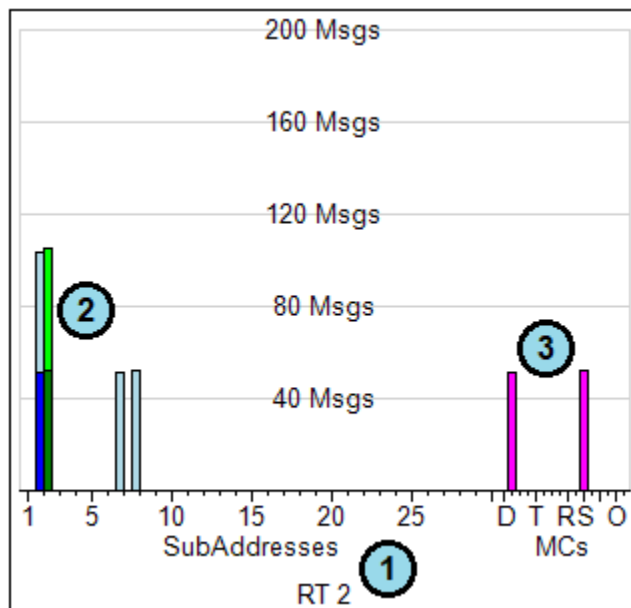

There are three different selections under the “Options” menu. They are all check box entries to act as toggles for the option. The three options are:

Display by Word Count – by default the graphs display messages by total message count, selecting this option counts the individual 16-bit words associated with the message in displaying. Normally if there are 500 messages for RT1-R-SA4 this would show up as 500 Msgs on the graph. If this option is selected the value will become 3000 Words, 500×6 words/message (Command Word, Status Word and the 4 Data Words).

Scale Each Graph – initially the graphs will be displayed with the same scale determined by the remote terminal with the most messages. Selecting this option causes each graph to auto scale to its own maximum message value.

Show Empty RTs – remote terminals that have no messages associated with them are not displayed by default. Selecting this option will display all 32 remote terminals (0-30 and Broadcast) regardless if they contain data or not.

Another feature of the histogram is that it will use the Search Tool of the parent dialog as a filter for the data. So if you only want Bus A messages displayed you can select the “Bus” A value from the Command Tab Bus combo box menu. All options on the Command, Status, Data and Errors tab will be used as data filters, the selections on the “Other” tab will not filter the data. The histogram will automatically update when filter selections are made.

BM Activity Viewer

The “Activity” button on the BM Control Panel provides an alternative view of the activity on the bus. This displays information for all RT addresses (0-31).

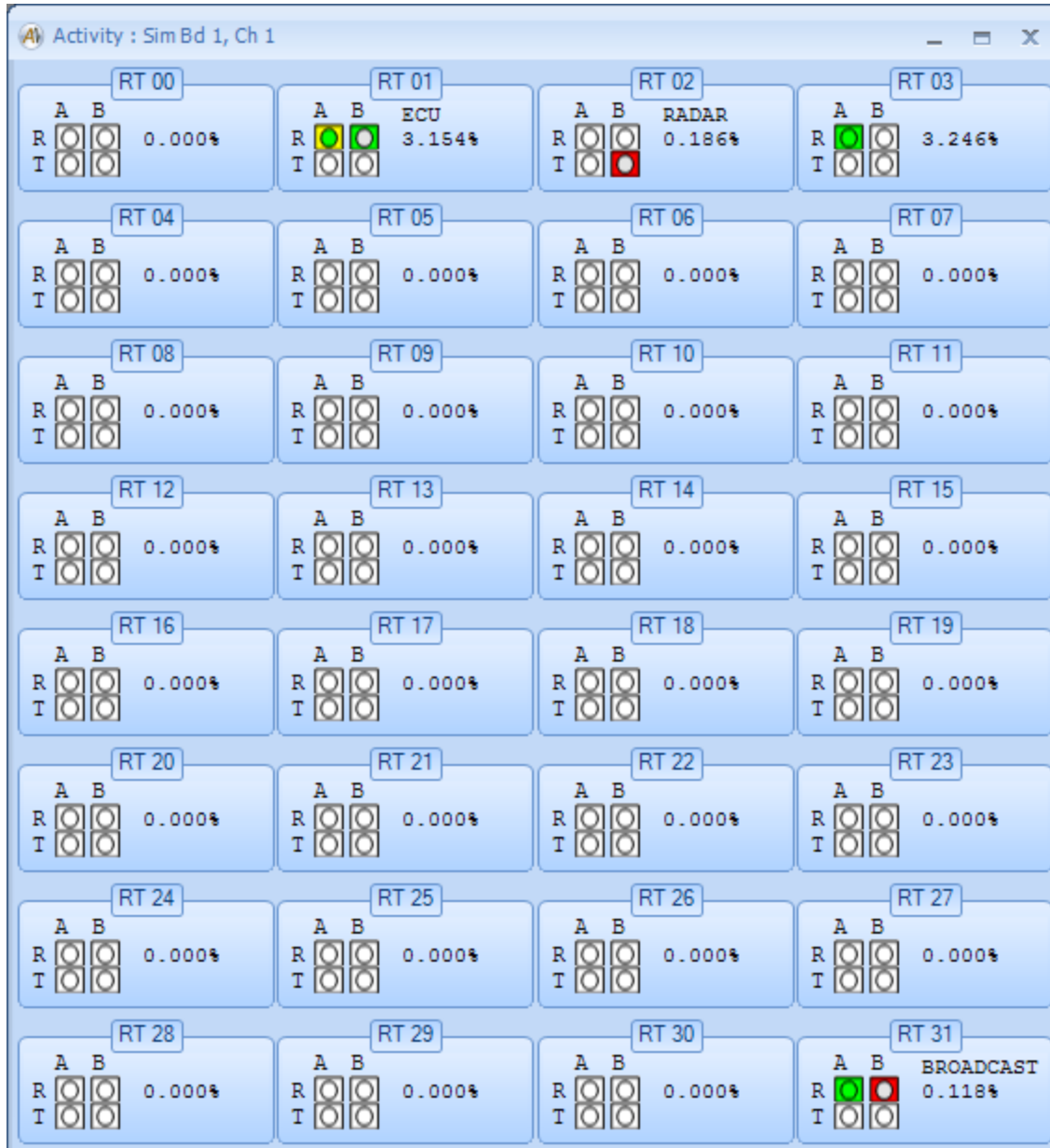

For any given RT address, four activity icons show activity by Receive and Transmit on Bus A and Bus B. The percentage bus loading is also shown for each RT. If you left-click on one of the RT panels, the view changes to show activity for all Sub-Addresses (0-31) for that RT address.

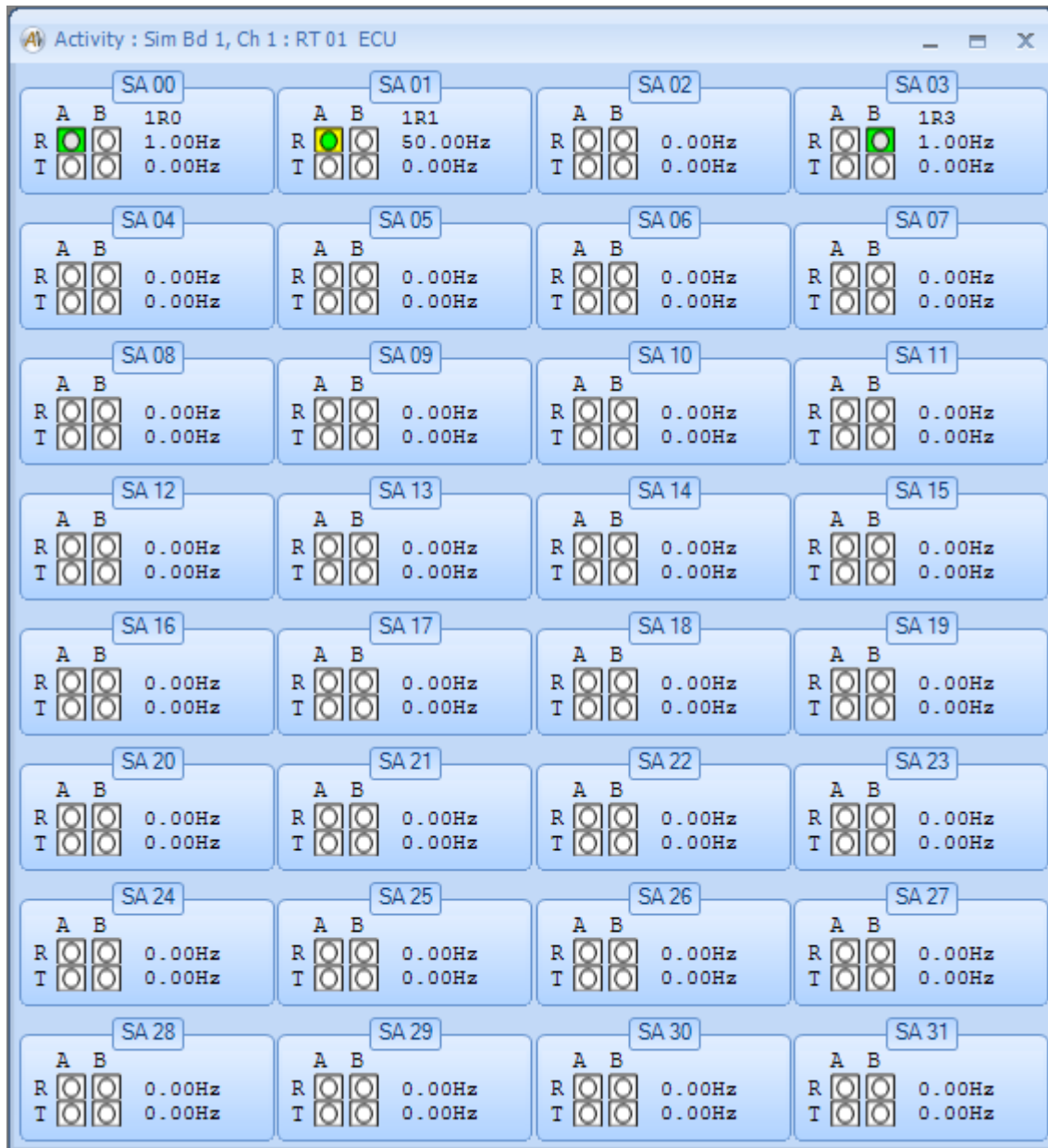

As for the RT level, four activity icons show activity by Receive and Transmit on Bus A and Bus B for each SA. On the right, the current message frequency is displayed for both receive and transmit messages. If you left-click on one of the SA panels the view will switch back to the RT level.

Statistics Tab

The “Statistics” tab provides detailed counters for messages, commands, errors, etc. as shown below:

The screenshot shows the BM Control software interface. The title bar reads "BM Control : SIM-1553 Bd 1 1553 Ch 1". The main window has a red header with "Snapshot Viewer", "Linked File Viewer", and "Auto Expand". Below this is a "Discovery" tab. The left pane shows a tree structure with nodes for "SIM-1553 Bd 1 1553 Ch 1 (Running)", "BUS A", "RT 01", "Receive", "SA 01 : 40.00 Hz", "Transmit", "SA 00 : 0.52 Hz", "RT 03", "Receive", "SA 01 : 30.30 Hz", "RT 31", "Receive", "SA 00 : 0.53 Hz", "SA 02 : 0.50 Hz", "BUS B", "RT 01", "Receive", "SA 03 : 0.53 Hz", "RT 02", "Transmit", and "SA 02 : 0.52 Hz". The right pane has tabs for "Control", "Statistics", "Frames", "Filters", and "Triggers". The "Statistics" tab is active, showing a "Top Level" summary with "Frames: 0" and "Messages: 3802", and a "Clear Counts" button. Below this is another "Top Level" section for "Bus Loading: 3.48 %" with a "Save to File" button. The "Commands" section lists BCRT (3574), RTBC (38), RTRT (114), and MODE (38). The "Broadcast" section lists BCRT (38), RTRT (38), and MODE (38). The "Errors" section lists Sync (0), Bit Enc (0), Parity (76), Wd Count (0), Two Bus (0), and Wrong RT (0). The "RT Status" section lists No Response (38), ME Bit (0), Busy Bit (0), and TF Bit (114). At the bottom is a "Summary Information" section with a table:

Summary Information			
Bus Loading	3.48 %	No Responses	38
Msgs/Second	52	Errors	76
Messages	3802	Spurious Data	0

The upper panel provides a top-level count of Frames and Messages. Frame counts are only enabled if a start-of-frame message has been defined in the “Frames” tab. A “Clear Counts” button is provided here as well – this is identical to the “Clear Counts” button on the “Control” tab.

The lower panel is dependent upon the node selected in the discovery tree. In this case, we have selected the node for Bus A, RT 01 (by left-clicking on the node). The lower panel shows the bus loading and count information for the selected level. If the top-level node for the channel is selected then the count information will apply to the entire channel.

A button is provided for “Save to File”. This allows you to save the current statistics to an ASCII text file. When you click this button this will open a Save File dialog where you can specify the file name to write. When you hit OK the

statistics information will be written to the file. Below is an example of what the text file will contain:

```
***** Bus A, RT 01 *****
Bus Loading      1.99 %
Commands        8013
  BCRT          7842
  RTBC          0
  RTRT          0
  MODE          171
Broadcast
  BCRT          171
  RTRT          0
  MODE          171
Errors          0
  Sync          0
  Bit Enc       0
  Parity        0
  Wd Count      0
  Two Bus       0
  Wrong RT      0
RT Status
  No Response   171
  ME Bit        0
  BUSY Bit      0
  TF Bit        0
```

Frames Tab

The “Frames” tab allows you to define a “start of frame” message, which is used by the frame counter under the “Statistics” tab.

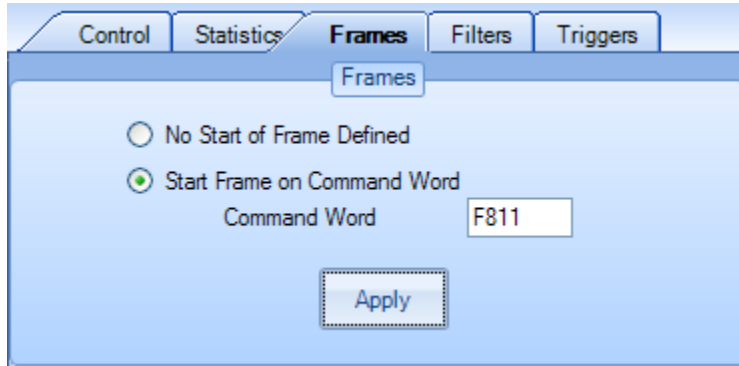

Filters Tab

The “Filters” tab allows you to define which messages to capture with the bus monitor.

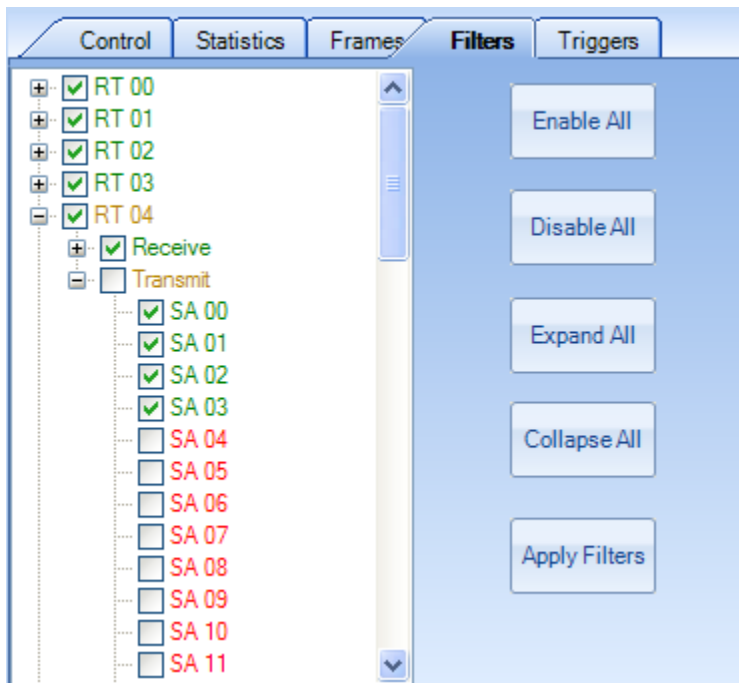

The “Enable All” button will enable the BM to capture all messages. The “Disable All” button will block all messages. The “Expand All” button will expand all nodes

of the tree. The “Collapse All” button will collapse all nodes of the tree. The “Apply Filters” button will apply the selected filters to the BM.

Triggers Tab

The “Triggers” tab allows you to define a trigger event that will start BM archiving to file. The board can also generate an output trigger signal when the trigger event occurs.

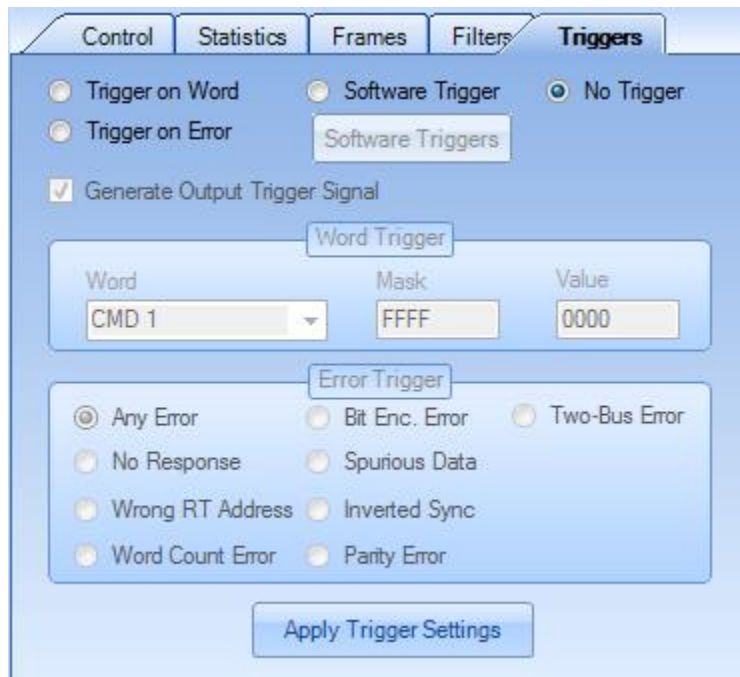

There are four basic trigger options:

1. No Trigger
2. Trigger on Word (hardware trigger)
3. Trigger on Error (hardware trigger)
4. Software Trigger

If “**No Trigger**” is selected then the BM will always trigger itself on the first message it sees and the board will not generate an output signal.

If “**Trigger on Word**” is selected, the 1553 device firmware will monitor for a user-specified data pattern. You will need to select the Word (CMD1, CMD2, STS1, STS2, or DATA1 - 32), a 16-bit Mask, and a 16-bit Value. The selected word from the 1553 message is first ANDed with the Mask then the result is compared to the Value. If the two are equal then AltaView will begin saving 1553 traffic to the selected archive file (if archiving has been enabled). The option to generate an output trigger upon each occurrence of the data pattern is also

available. NOTE: **Be sure to click ‘Apply Trigger Settings’ to finalize trigger setup.**

If “**Trigger on Error**” is selected you will need to select either “Any Error” or one of the specific error types (No Response, Parity Error, etc.). Upon the first occurrence of the error condition, AltaView will begin saving 1553 traffic to the selected archive file (if archiving has been enabled). If the option to generate an output trigger is selected, the output trigger will be asserted each time the error condition is detected in a message. NOTE: **Be sure to click ‘Apply Trigger Settings’ to finalize the trigger setup.**

If “**Software Trigger**” is selected, the Software Triggers button is enabled. This button brings up a dialog-box where you can define trigger conditions the same way you define search parameters in the BM Snapshot and File Viewers.

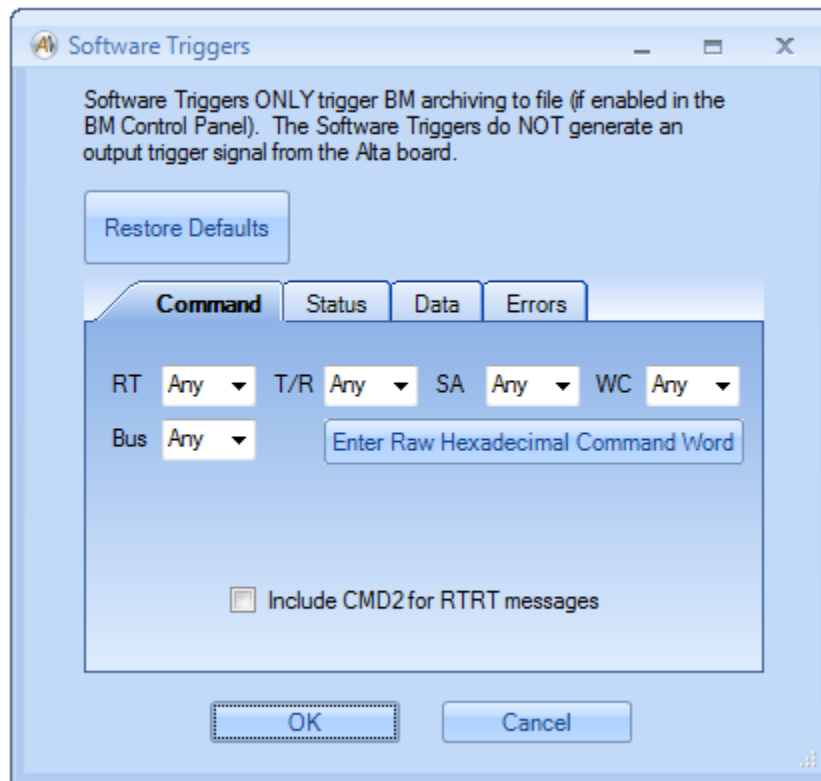

Again, a trigger event can do two things for you:

1. Start the BM archive to file.
2. Generate an output trigger signal from the board (‘Trigger on Word’ and ‘Trigger on Error’ triggers only).

Obviously, you can only start BM archive to file from the trigger if you have enabled archiving in the “Control” tab.

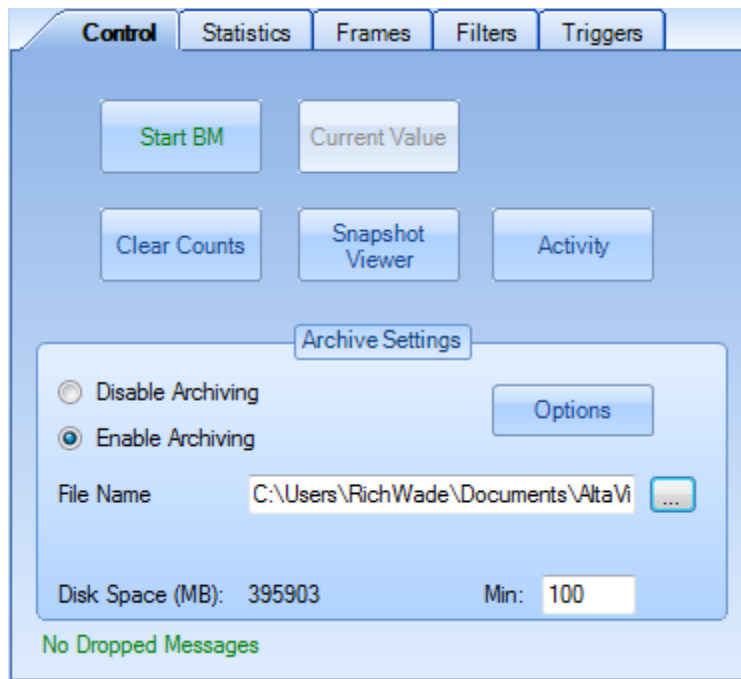

If you have enabled a trigger you will be able to set the “# Msgs Before Trigger” found in the Archiving Options dialog (open this dialog with the “Options” button on the “Archive Settings” panel. This allows you to specify the number of messages preceding the trigger message to be stored in the archive file. If this value is zero then the first message in the file will be the trigger message.

If you want the board to generate an output trigger signal every time the trigger condition occurs (‘Trigger on Word’ and ‘Trigger on Error’ options only), check the box for “Generate Output Trigger Signal”. The trigger signal will be generated shortly after the end of the message that causes the trigger to be asserted (after all Command, Status, and Data words have been sent and the board has finished processing the message).

The following oscilloscope trace shows a trigger on CMD1, looking for 0x0C02 (1-T-0-2, Transmit Status Mode Code).

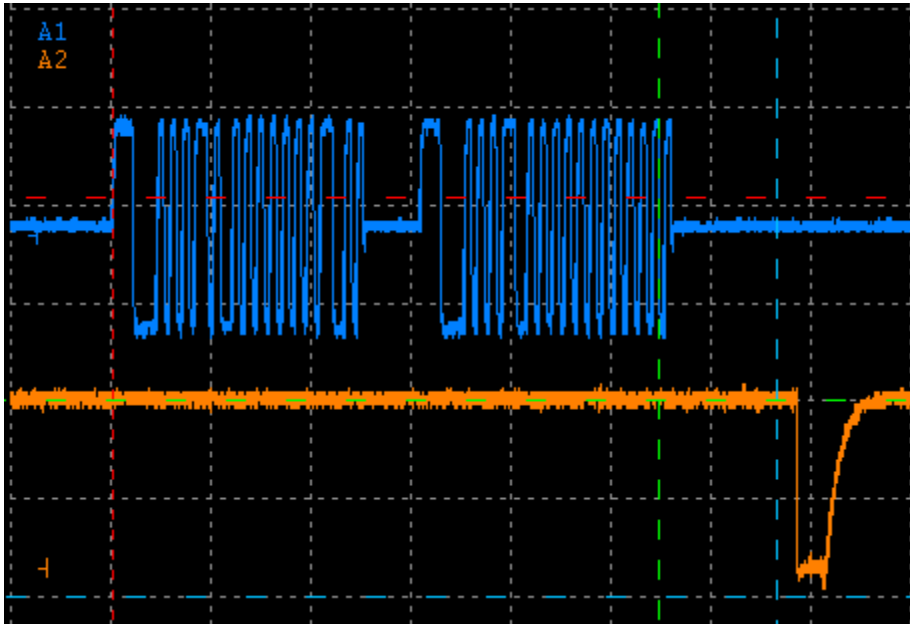

Even though our trigger is looking for the Command word, the entire message must complete before the trigger signal is generated. In this case the trigger signal is seen approximately 10 microseconds after the end of the Status word from the Remote Terminal.

NOTE – You MUST click the “Apply Trigger Settings” button for any of your settings to be used! Hardware triggers must be written to all BM CDP buffers (3000 buffers) - a status message will be displayed asking you to wait while the trigger settings are written to the device:

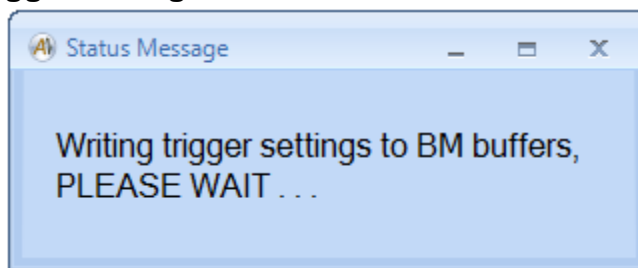

This process generally takes less than a second on PCI/PCIe boards. For ENET devices this can take longer, depending on path delay.

NOTE – You MUST start the BM before the board will generate output triggers or archive to file.

Start BM

The “Start BM” button will start the Bus Monitor for the selected 1553 device. This button does not activate any other forms or windows.

Stop BM

The “Stop BM” button will stop the Bus Monitor for the selected 1553 device. This button does not activate any other forms or windows.

File Viewer

The “File Viewer” button will bring up the 1553 BM File Viewer window (unlinked File Viewer). Note that this control is not associated with a specific device and may be used even if no devices are open under *AltaView*.

If you want a “Linked File Viewer”, which is associated with a specific 1553 device, then use the “Linked File Viewer” menu-strip option in the 1553 BM Control Panel for that device. Refer to the section on the 1553 BM Control Panel for details on this.

The File Viewer is very similar to the Snapshot Viewer, but it operates on a saved file rather than on a memory snapshot.

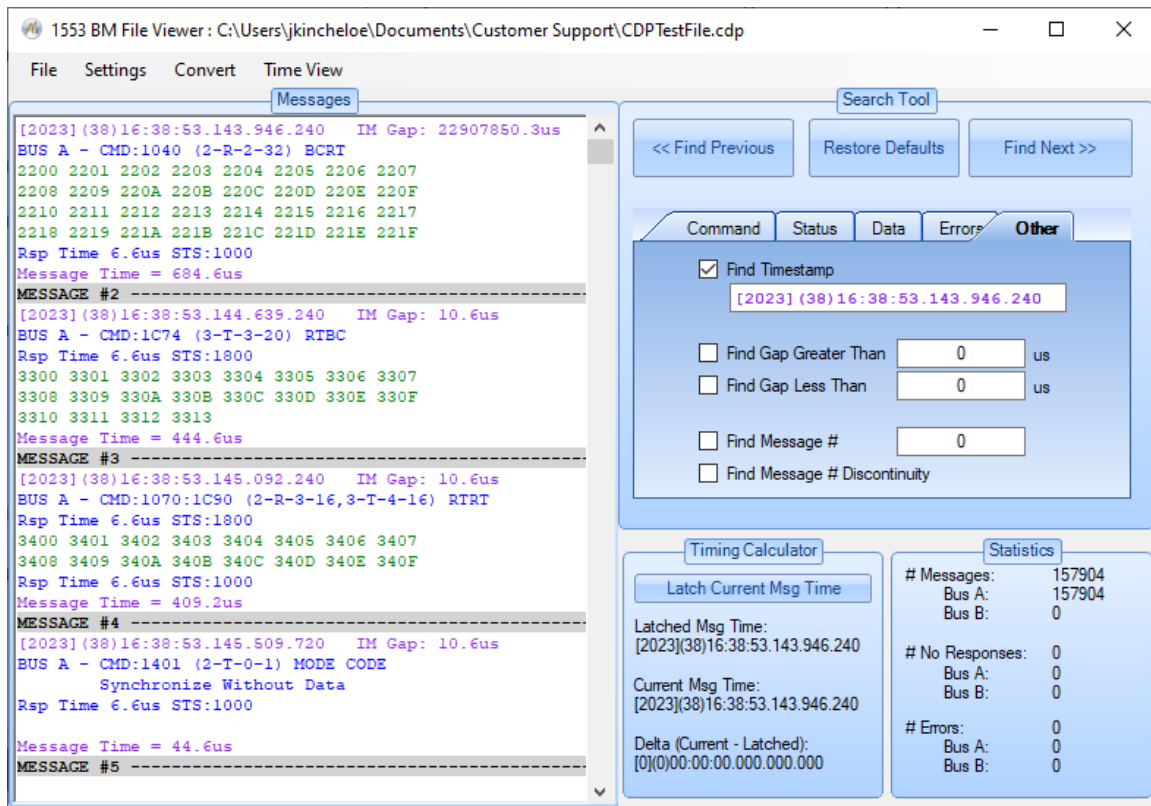

Note that the menu-strip provides a “File” option rather than the “Refresh Snapshot” option found in the Snapshot Viewer. Use the “File” menu to load a saved 1553 bus monitor file.

The Search Tool, Timing Calculator, and Statistics panels have all of the functionality found in the Snapshot Viewer. Also selecting the “Time View” option opens the Graphical 1553 Message viewer similar to the one available from the Snapshot Viewer. Its functionality is described under the Snapshot Viewer section above.

Another difference in the File View is under the Convert menu option the user can select “From CSV”. This option allows the user to convert a CSV file of 1553 messages that are in the same format as those created from CDP files in AltaView to a binary CDP format.

The “From CSV” option will open the following dialog box:

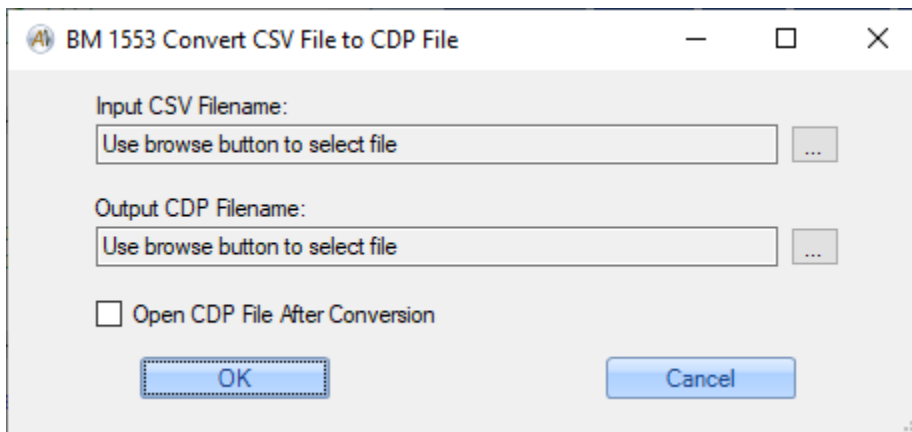

By clicking on the ellipse button to the right of the “Input CSV Filename” text box an “Open” file dialog will appear allowing the user to select the CSV that will be converted to a CDP file. It is important to select a CSV that is in the same format as the CSV files created by AltaView from a CDP file. Clicking on the ellipse button to the right of the “Output CDP Filename” text box as “Save” file dialog will appear where the user can input the output CDP filename that the converted CSV file will be saved as.

The “Open CDP File After Conversion”, if checked, will load the newly created CDP file into the File Viewer.

Find Timestamp

The File Viewer provides an additional function not available in the Snapshot Viewer – the Find Timestamp search located in the ‘Other’ tab.

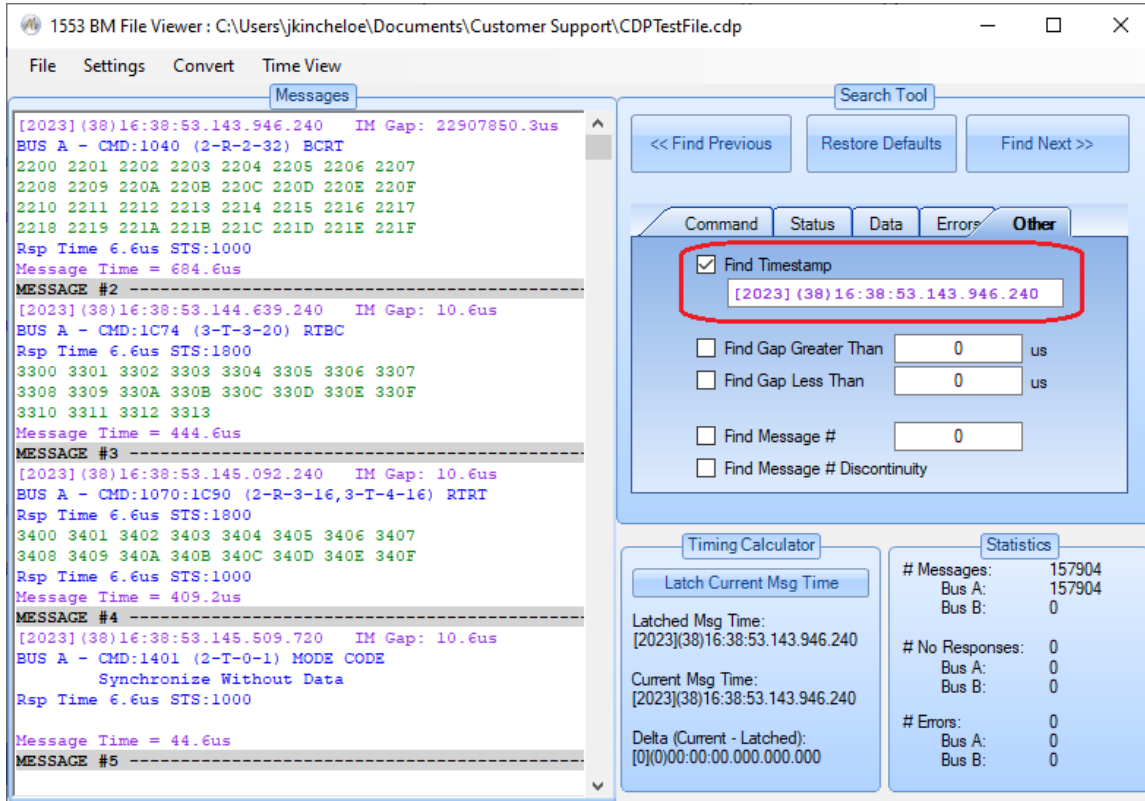

The Find Timestamp value is updated with the timestamp value of the first message displayed in the ‘Messages’ list. To search for a specified timestamp:

1. Check the Find Timestamp checkbox,
2. Enter a timestamp value to search for,
3. Click either the ‘Find Previous’ or ‘Find Next’ button.

* Note that the timestamp value to search for does not need to be specified to the full 20 nanosecond precision of a timestamp:

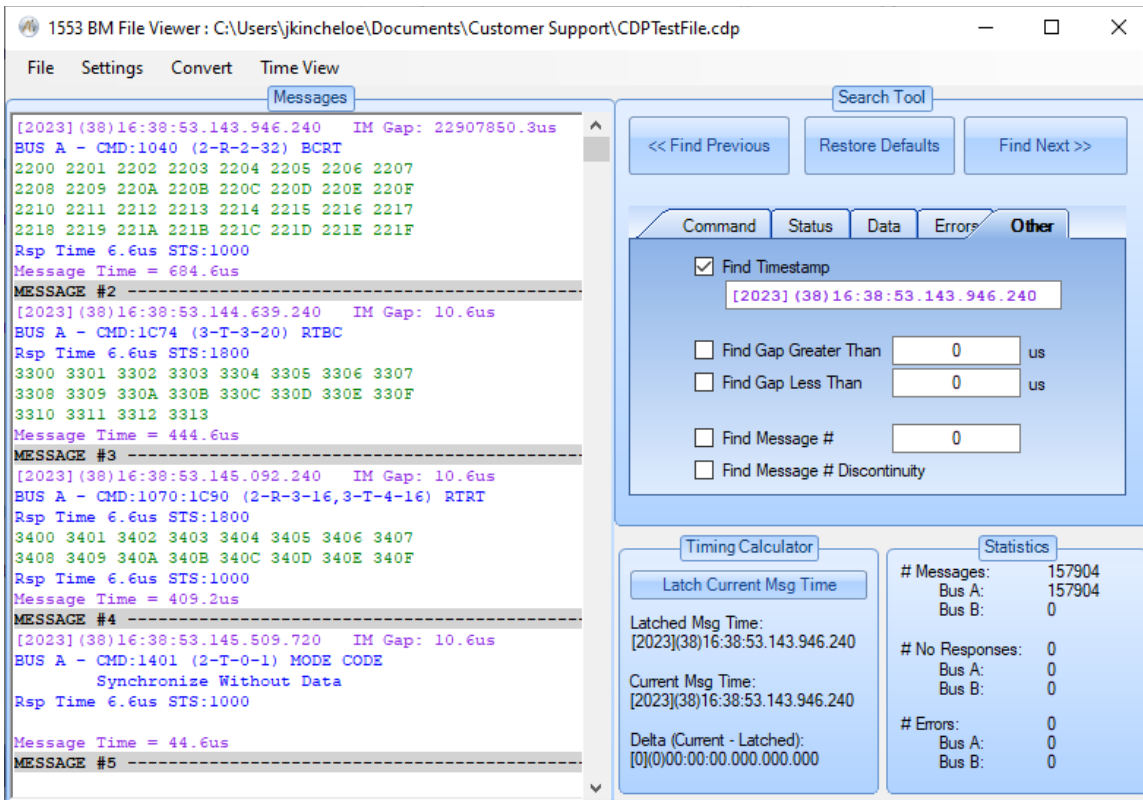

Signal Viewer

The Signal Viewer uses an A/D (analog to digital) converter to display the electrical signal on the selected 1553 bus (A or B). Note that not all Alta 1553 boards/channels include the A/D converter needed for the Signal Viewer – the “Signal Viewer” button is only enabled if it is present on the selected channel. **If the device is not enabled for full analyzer operation the Signal Viewer feature is disabled.**

NOTE: On versions 4.0.0.0 and earlier Windows 7 “Aero” themes (with “glass effects” and other gee whiz graphics features) can cause the Signal Viewer to flicker a lot as the display updates while the viewer is running. This is not a problem but can be annoying. You can fix this by closing **AltaView**, change to a “Basic” theme, and then run **AltaView** again – now when you run the Signal Viewer you should no longer see the flicker.

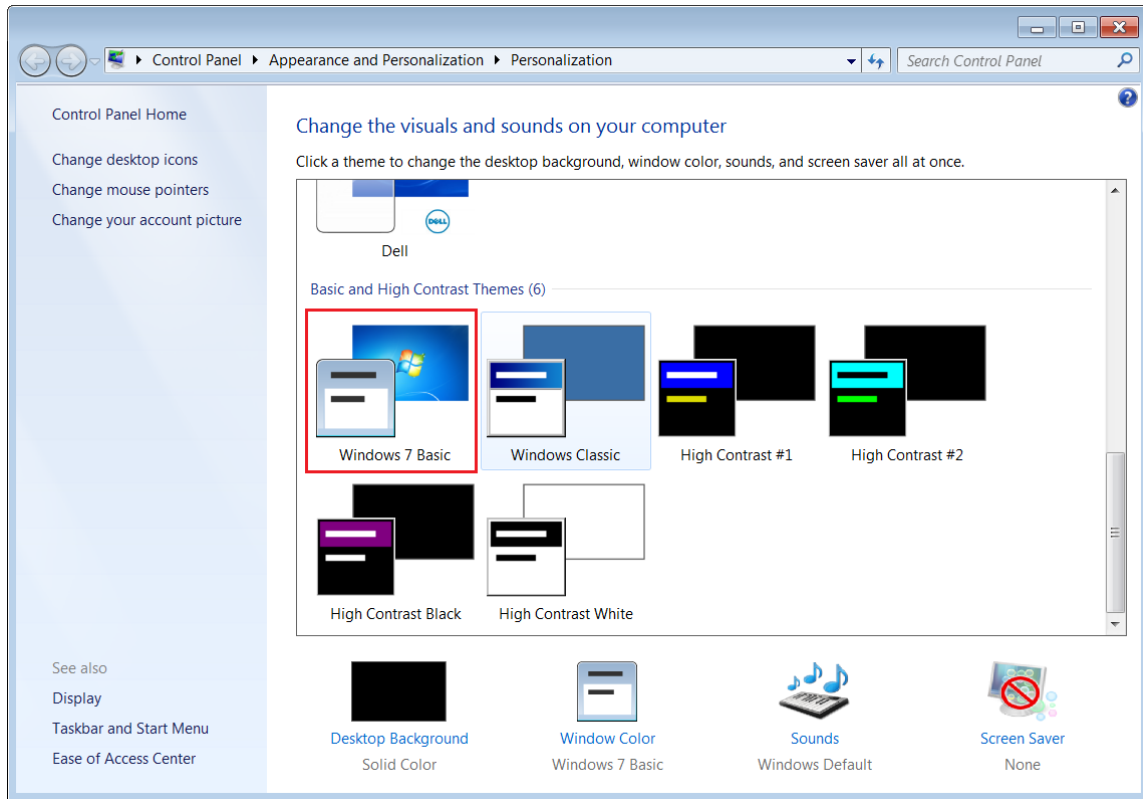

The “Signal Viewer” button will bring up the 1553 Signal Viewer window in the Capture Signal Tab.

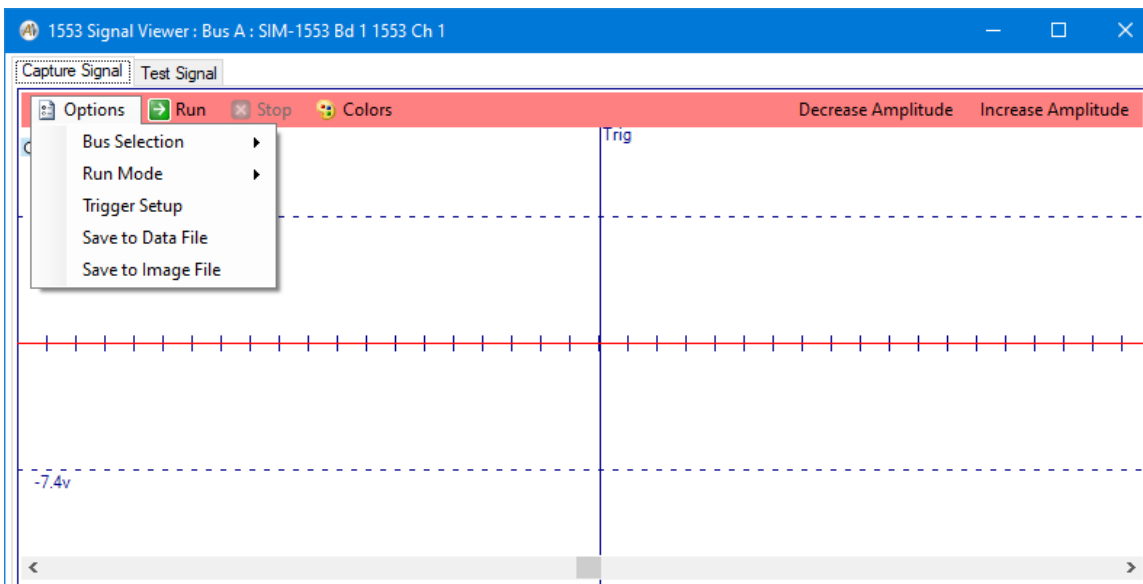

The menu-strip provides the “Options” pull-down menu to select the Bus (A or B), select Run Mode (Single or Continuous), setup Triggers, and Save waveform to file. If you save to a data file this can be used with a spreadsheet (explained below). If you save to a JPG/PNG/GIF file this saves the image of the graph.

The “Run” button starts the signal capture. The “Stop” button stops the signal capture.

The “Colors” pull-down menu provides options to change the background color (default is white), foreground color (default is dark blue), and signal color (default is red).

On the right side of the menu strip two buttons are provided to decrease or increase the displayed amplitude of the signal. The voltage reference lines (dashed lines) are marked with the voltage value based on the amplitude scale setting.

WARNING: The voltage scale is an estimate that should be accurate to within 1V. Use an oscilloscope for more accurate measurements.

The vertical tick-marks on the zero-voltage line indicate time in one microsecond steps – each tick-mark represents one microsecond.

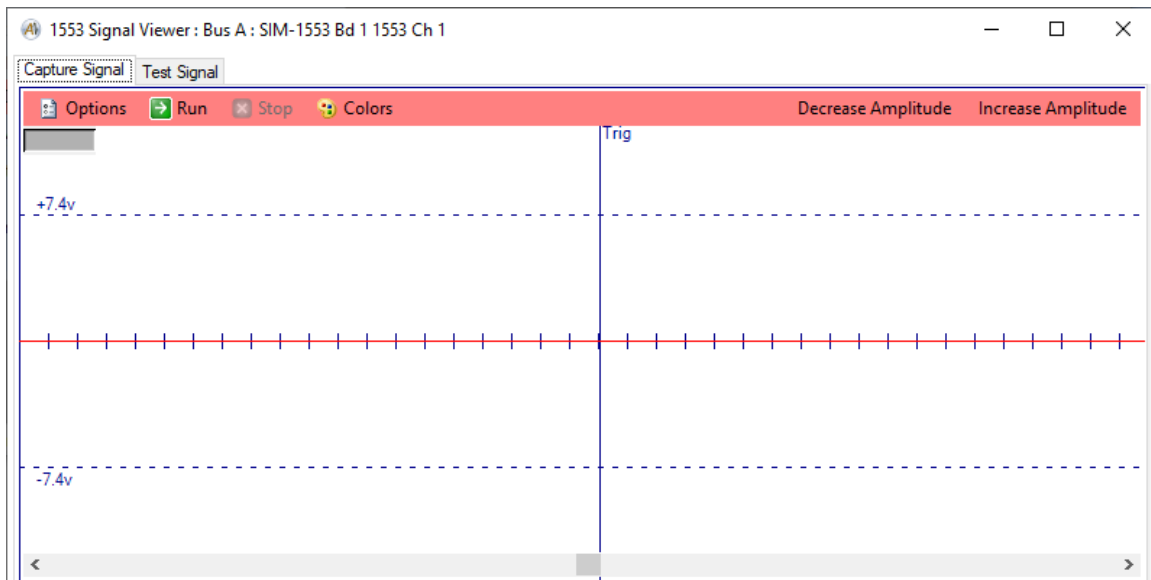

The Signal Viewer will capture 2048 samples at a rate of 20MHz, or 50 nanoseconds per sample. Therefore the sample buffer contains 102.4 microseconds of data. Each sample is an 8-bit value representing the differential

voltage on the 1553 bus, where the maximum value is 30 volts. The horizontal scroll-bar at the bottom of the window allows you to move through the 102.4 microsecond data buffer to view any part of the captured signal. Under Options, a selection is provided for **Save to Data File** – this will save the 2048 samples to a text file where each sample is a value from 0 to 255, a value of 0 represents -15 volts and a value of 255 represents +15 volts. This can be used in a spreadsheet to draw the waveform as a chart.

Note that you can also resize the window to display a larger portion of the buffer.

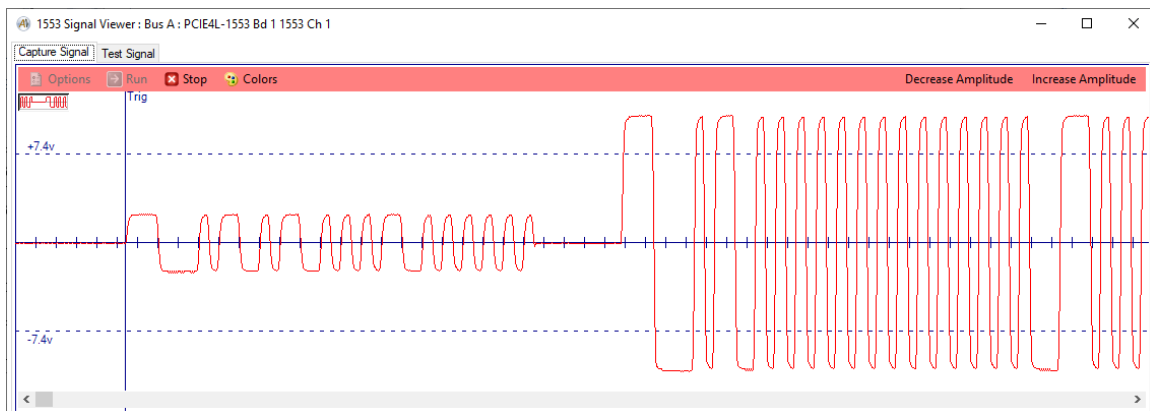

WARNING: The Signal Viewer does NOT replace a calibrated oscilloscope for voltage or timing measurements on the 1553 bus. The Signal Viewer provides simple voltage and timing scale markers. If more precise information is needed about the electrical signal on the 1553 bus a real oscilloscope should be used. Appendix D of the *AltaRTVal* User's Manual explains how to use an oscilloscope on the 1553 bus.

WARNING: You can use two instances of the 1553 Signal Viewer to simultaneously see the signals on Bus A and Bus B. However, the two viewers are triggered independently so the two viewers will show signals at different times, they are NOT time correlated (as would be the case with a two channel oscilloscope using a common trigger).

Test Signal Tab

Test Signal Tab has the same capabilities as above with added functionality to evaluate Signals against a Reference Signal.

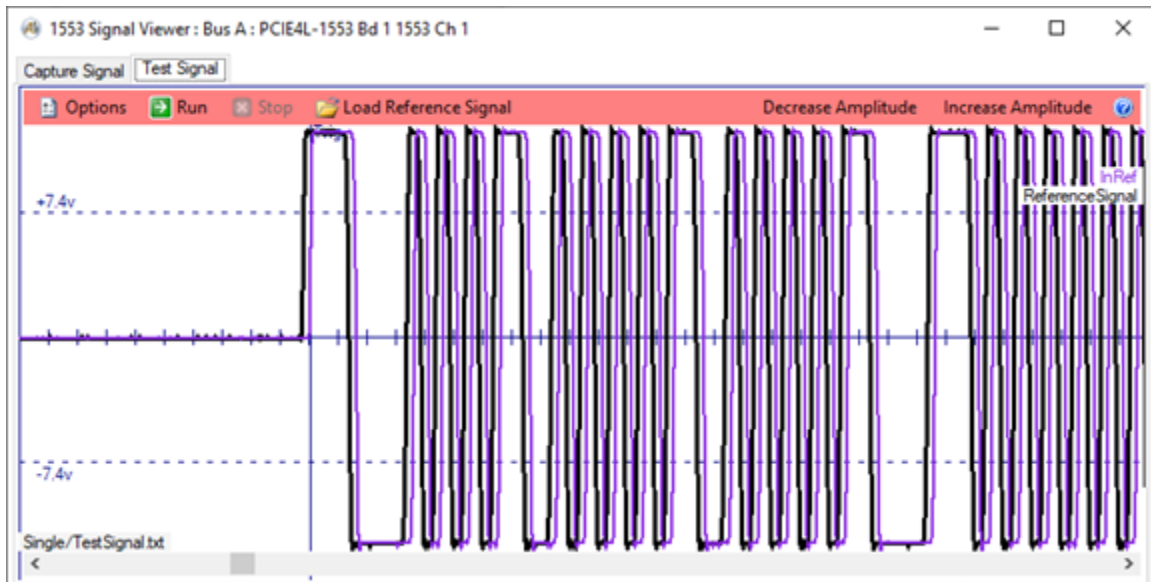

The Options button on Test Signal Tab has another option under the Run mode. This is Load Test Signal button which allows a signal's data saved previously to be used as the signal to compare to the Reference signal. The Test Signal will be drawn in Purple.

“Load Reference Signal” button Loads the reference from a file of saved data values and graphs it as a black line. The reference signal line can be removed from the graph by choosing the “Clear Reference Signal” under the Options menu.

When working with A Single Signal from a 1553 channel it is best to synchronize the signal with a reference signal. This can be done on the Signal Capture Trigger Setup by selecting the Trigger to Any Command radio button and setting the trigger position to 0%. This synchronizes the reference signal and the test signal for a more accurate comparison.

In the “C:\Program Files\Alta Data Technologies\Alta Software\AltaView\Win64\bin\” directory are a configuration file and three saved signal files that can be used to test the functionality and capabilities of the Test Reference Signal.

The AltaView configuration file “Brdcst MC Sync Data.xml” sets up a Bus Controller with a single Broadcast Sync with Data Mode Code to transmit, this will be convenient because you will be able to see the entire two 32-bit word message in the Signal Viewer Window and since it is a broadcast message no

Status response is required from a remote terminal. The configuration also opens the Signal Viewer Window.

The three saved signal files are:

“Good Signal – Terminated.txt”, this is a file of 2048 byte integers (0-255) which represent voltages from -15v to 15v (conversion: volts = $(\text{value} * 30) / 255 - 15$). This signal represents a BC message on a properly terminated bus.

“Bad Signal.txt” – This signal represents a BC message on a properly terminated bus with both strong and weak signal words.

“Bad Signal – no Terms.txt” – This signal represents a BC message on an unterminated bus.

These test signal files may be used as either the reference signal with which to compare an actual device signal generated using the provided AltaView configuration file or as a saved test signal to compare with another reference signal file.

Trigger Setup

The Trigger Setup item under the Options menu provides multiple options for triggering on Signal Capture Data.

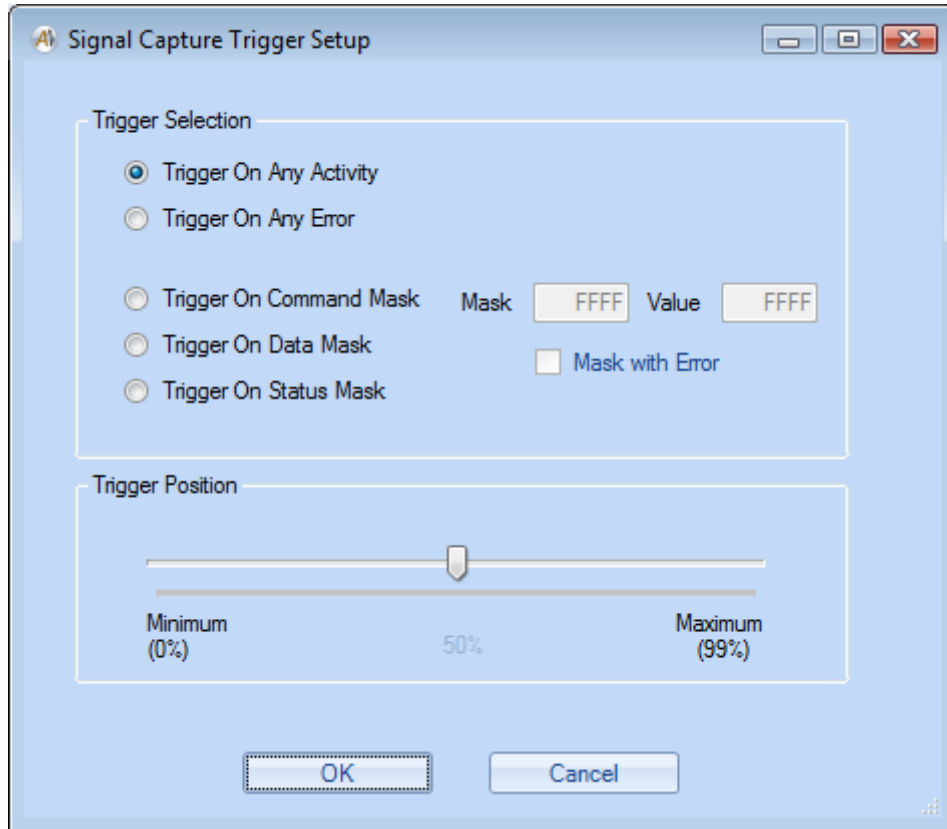

NOTE: All Triggers, except for Trigger on Any Activity, are captured at the end of the 1553 word/event from which the event occurred (so the trigger is marked at the end of the word). For Trigger on Any Activity, the trigger is marked at the position where activity is first detected.

Trigger on Any Activity

This option will cause the signal capture detection circuit to trigger on any activity detected on the 1553 stub.

Trigger on Any Error

This option will cause the signal capture detection circuit to trigger on any 1553 protocol error detected on the 1553 stub.

Trigger on Command Mask

This option will cause the signal capture detection circuit to trigger on a BC Command Word when the Mask\Compare equals TRUE.

Trigger on Data Mask

This option will cause the signal capture detection circuit to trigger on a Data Word when the Mask\Compare equals TRUE.

Trigger on Status Word Mask

This option will cause the signal capture detection circuit to trigger on a RT Status Word when the Mask\Compare equals TRUE.

Trigger on Mask with Error

If this checkbox is checked, the Signal Capture will trigger on Mask\Compare equals true AND any 1553 protocol error detected on the 1553 stub.

Trigger Position

The Trigger Position setting sets the trigger position in the Signal Capture Buffer. The Signal Capture Buffer contains 2048 positions, so if the trigger position is set to 50% for example, this would represent position 1024.

Each position represents a 50 nSec time value, so the Signal Capture buffer can contain $(2048 * 50\text{ns}) \sim 102 \text{ uSec}$ worth of data. For example, if the trigger position was set to 50% (position 1024) this would provide around 51uSec worth of pre-trigger data and 51us of post-trigger data.

Data Table

The 1553 BM Data Table can display selected data parameters in engineering units. **If the device is not enabled for full analyzer operation the Data Table feature is disabled.** Initially, you will have an empty table with one blank row.

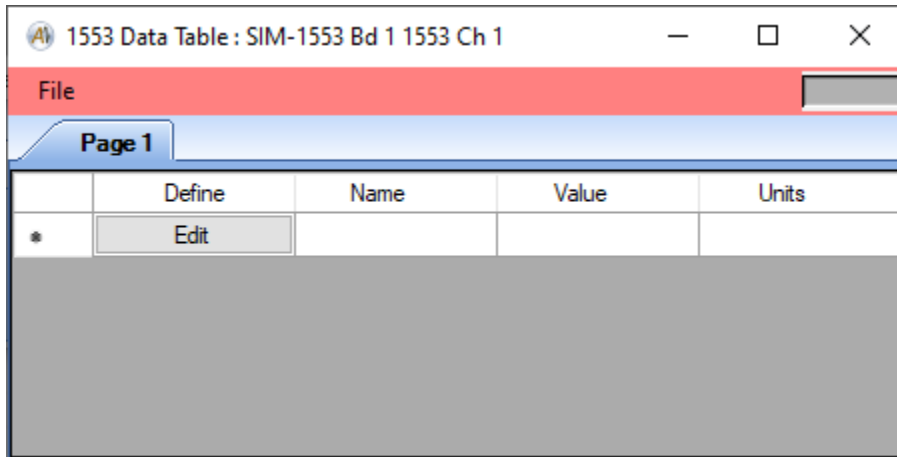

You can define a data parameter by clicking on the “Edit” button on the blank row. This will bring up the Parameter Definition dialog-box.

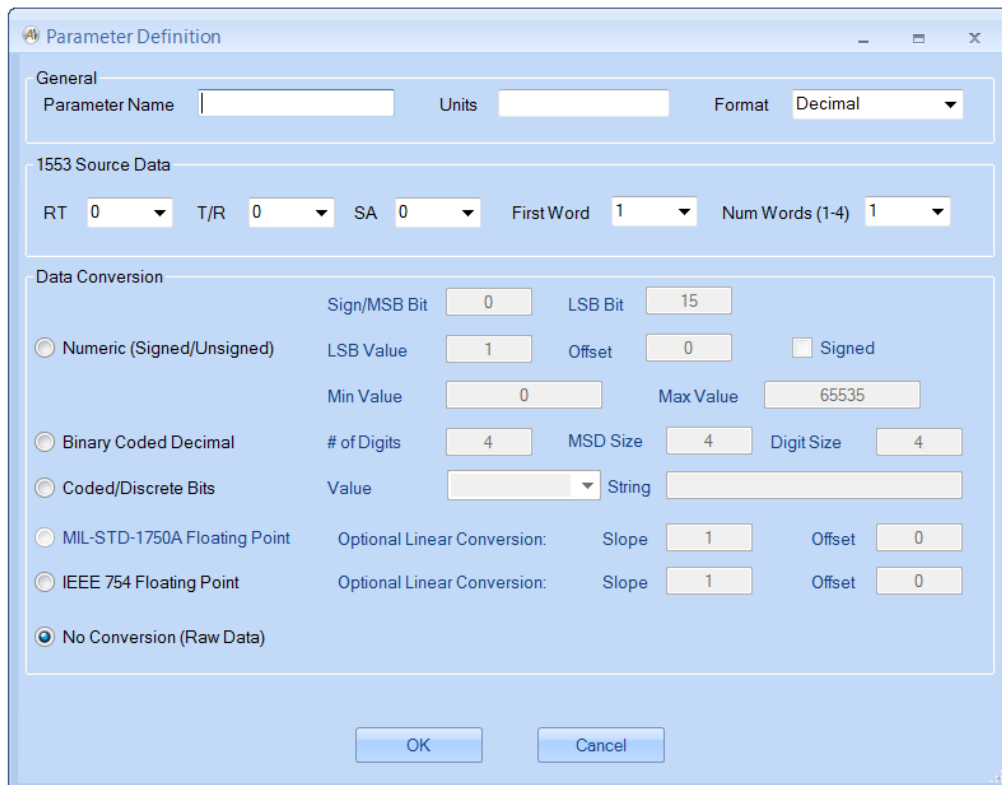

Enter the desired Name and Units – these can be any text string. Format can be Decimal, Hexadecimal, or Binary.

Define the 1553 Source Data by specifying the RT (0-31), Transmit/Receive (1/0), SA (0-31), First Data Word (1-32), and the Number of Data Words (1-4). Note that a single parameter can include up to four 16-bit 1553 data words (64-bits total) – the first data word is the most significant word.

Five Data Conversion types are available – Numeric, BCD, Code/Discrete Bits, MIL-STD-1750A Floating Point, IEEE 754 Floating Point, or No Conversion.

NOTE ON BIT ORDERING – We use the bit ordering convention specified in MIL-HDBK-1553A Section 80 (Parameter Formats), where the most significant bit (MSB) in a 1553 word is bit number 0 and the least significant bit (LSB) is bit number 15.

The “No Conversion” option allows you to display the raw data word(s) as an unsigned value in Decimal, Hexadecimal, or Binary format.

The “Numeric” option allows you to define a range of bits to be displayed as a signed (2’s complement) or unsigned number. The bit range is defined from the Sign/MSB Bit through the LSB Bit, where the bit numbers start at zero – for example the full range of a 16-bit word would use bit 0 as the Sign/MSB bit and bit 15 as the LSB bit. This uses the bit-ordering convention defined in MIL-HDBK-1553A Section 80. You can specify the value of the Least Significant Bit (LSB) and you can select Signed or Unsigned. The software will display the minimum and maximum values based on your selections. Note that you can also enter an “Offset” value – this allows you to define a linear conversion ($y = mx + b$) where the slope (m) is the “LSB Value” and the offset (b) is the “Offset”. Set “Offset” to zero if it is not used.

The “Binary Coded Decimal” option allows you to define a range of bits to be interpreted as BCD digits. BCD values will always be positive, so the minimum value cannot be less than zero. The maximum value determines the location of the decimal point – for example, if we have a four-digit BCD parameter with a maximum value of 99.99, this tells us that the decimal point goes between the second and third digits. Note that you can specify the number of BCD digits, the size in bits for the most significant digit, and the size in bits of the other digits – normally all BCD digits will be 4-bits, but this allows you to handle cases where one or more digits use fewer bits (as is seen with some ARINC429 labels).

The “Coded/Discrete Bits” option allows you to define one or more bits as a coded field where each possible value maps to a user-defined string. For example, a given bit could represent “ON” if the bit is set and “OFF” if the bit is clear. When you select the radio-button for “Coded/Discrete Bits” you will be asked to confirm the start and end bits for the field – this is needed in order for the software to allocate the appropriate number of entries in the string table for the field.

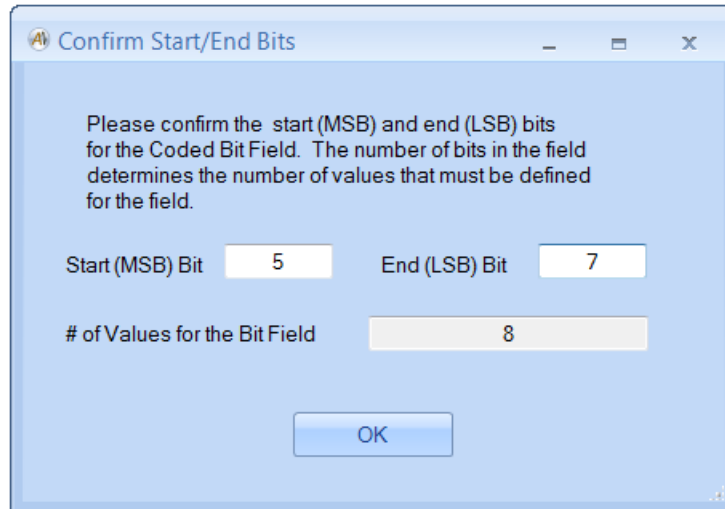

You cannot change the field size for “Coded/Discrete Bits” after the object has been created. If you need a different size you must create a new parameter with the new field size. Once you have confirmed the field size, the Parameter Definition dialog will enable the “Value” combo-box and the “String” text box. Use the “Value” combo-box to select each of the possible values for the field and enter a corresponding string in the “String” text box.

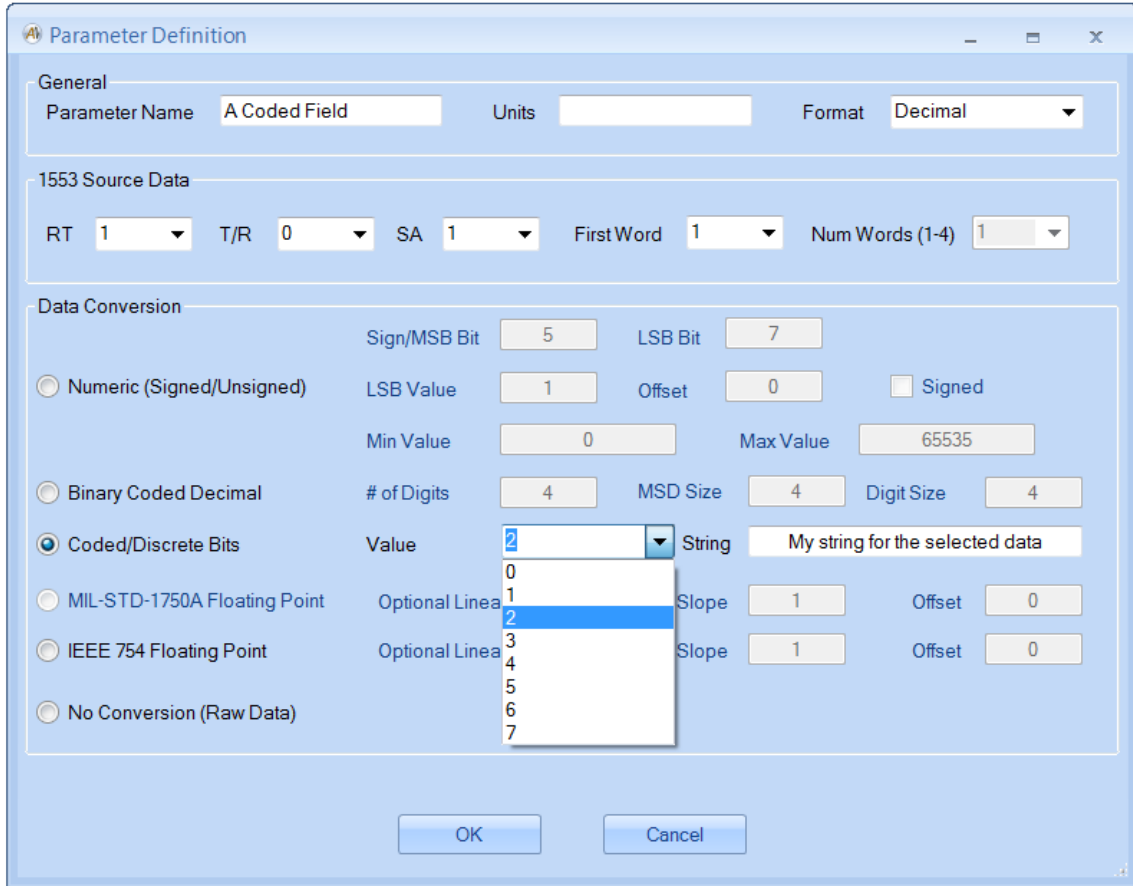

The “MIL-STD-1750A Floating Point” option allows you define 32-bit (2 word) or 48-bit (3 word) floating point values. For details on these formats, please refer to: <http://www.xgc.com/manuals/m1750-ada/m1750/c189.html#AEN322>

Note that the radio-button selection for “MIL-STD-1750A Floating Point” is only enabled if the selected number of 1553 data words is 2 or 3. Optional fields are provided for linear ($y = mx + b$) conversions on the floating point data. The “Slope” field corresponds to m and the “Offset” field corresponds to b . Set “Slope” to 1 and “Offset” to 0 if this is not used.

After you finish making entries in the Parameter Definition dialog-box and hit “OK”, your new parameter will be added to the table.

	Define	Name	Value	Units
▶	Edit	A Raw 32-bit Value	C4EE8E06	
	Edit	A Binary Value	1100 0100 1110 1110	
	Edit	A Signed Numeric	-151.22	Feet
	Edit	A BCD Value	78.39	Degrees C
	Edit	A Discrete Bit	OFF	
	Edit	A Coded Field	North	
*	Edit			

Each time you define a parameter the Data Table adds a new row. Therefore you always have an empty row at the end of the table that can be used to define a new parameter.

You can edit existing parameters by clicking on the “Edit” button for the appropriate row in the table. You can delete parameters by clicking to the left of the row to select the row then pressing the “Delete” key on the keyboard. You can sort the table by clicking on the column headings to sort by Name, Value, or Units (can sort by increasing or decreasing order). You can resize the window and you can change the widths of the columns as desired.

You can right-click on a tab-page to Add, Delete, or Rename tab-pages. This allows you to organize data parameters in functional groups.

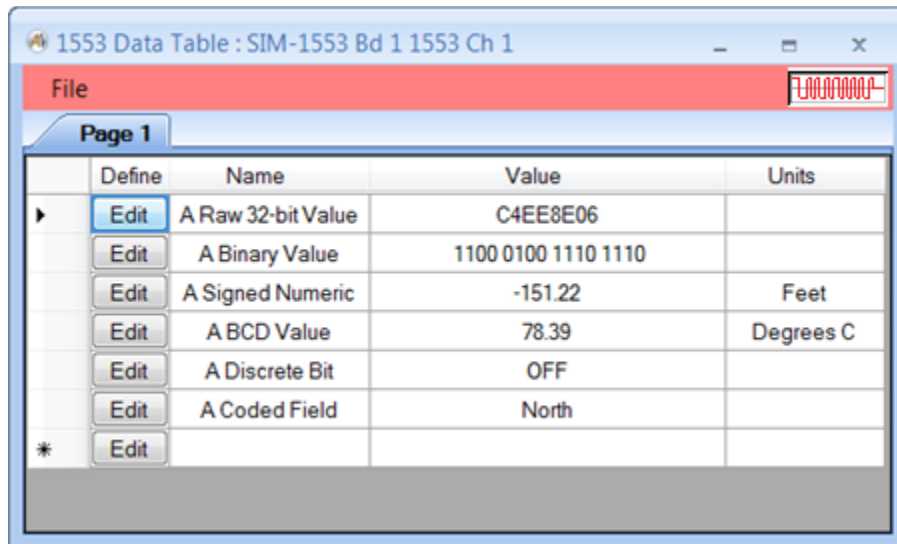

	Define	Name	Value	Units
▶	Edit	A Raw 32-bit Value	C4EE8E06	
	Edit	A Binary Value	1100 0100 1110 1110	
	Edit	A Signed Numeric	-151.22	Feet
	Edit	A BCD Value	78.39	Degrees C
	Edit	A Discrete Bit	OFF	
	Edit	A Coded Field	North	
*	Edit			

Note that you cannot delete the last remaining tab-page. The entries can also be Copy and Pasted to any tab on this dialog.

The values in the Data Table will update twice per second (2 Hz). The data comes from the 1553 BM internal current value table. Therefore the BM must be running or the Data Table will not see new data.

The “File” menu-strip item allows you to Save or Load your data table pages and definitions. This uses a XML file format.

Remote Terminal Tools

The Remote Terminal tools provide controls for RT operation. **For dual-function devices the operator will be prompted to open the device in either Remote Terminal or Bus Controller mode. If RT mode is chosen, the Bus Controller Tools are disabled and the device must be closed, then reopened to switch to BC mode.**

RT Control

The “RT Control” button will bring up the RT Control Panel for the selected 1553 device. This is the main window for all Remote Terminal operations for the device. **If the device is not enabled for full analyzer operation, the Add All RTs, Enable/Disable RT, Edit Status Bits, Set Response Time, Error on Status, Legalization, Pattern Data, and Error on Data features are disabled.**

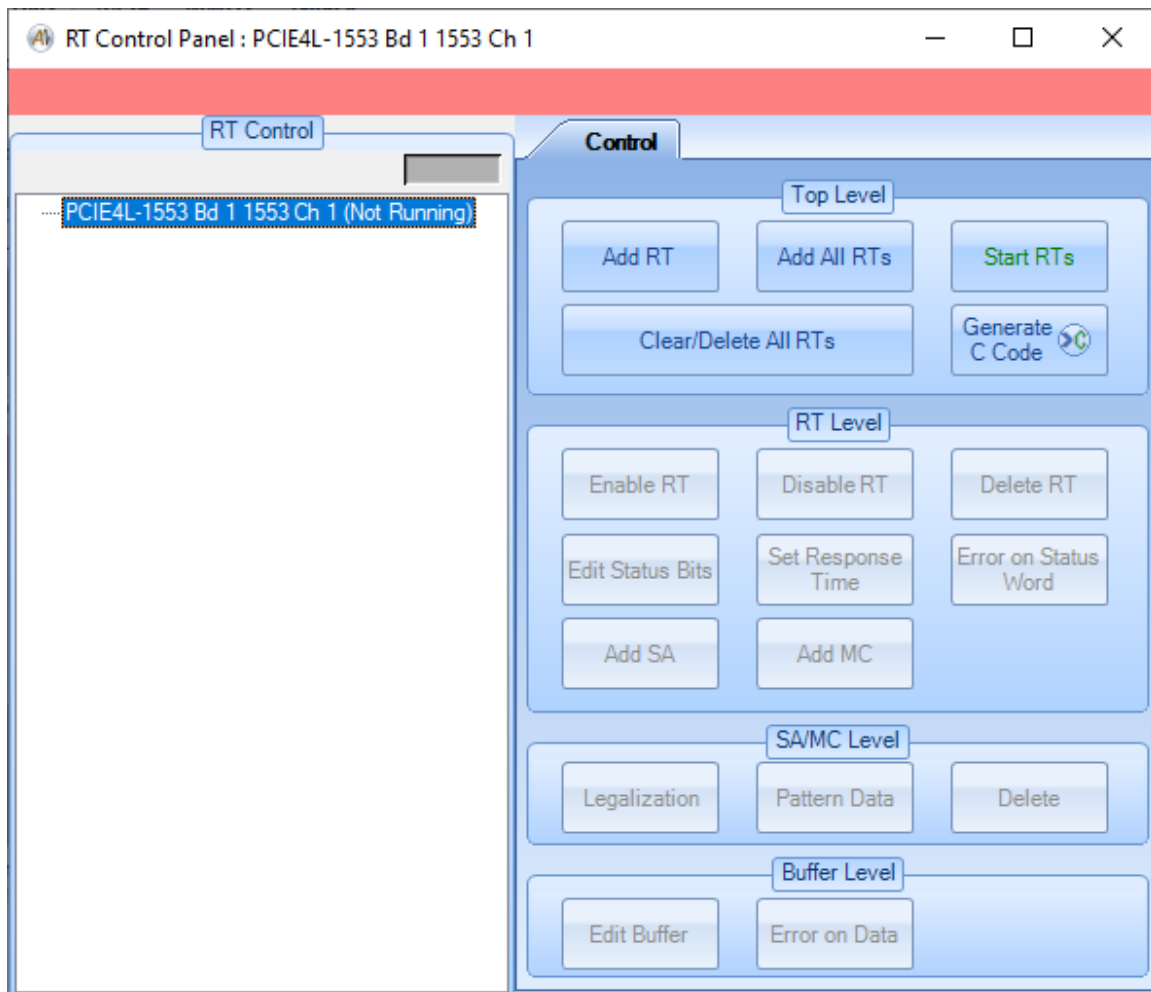

The RT Control Panel provides both control buttons and context-menus. Right-click on a node in the RT Control tree to bring up the appropriate context-menu for that node.

If no RTs are defined, the tree will only show the top-level node for the device. You can add RTs by right-clicking on the top-level node and selecting “Add RT”. This will bring up the “Add RT” dialog box.

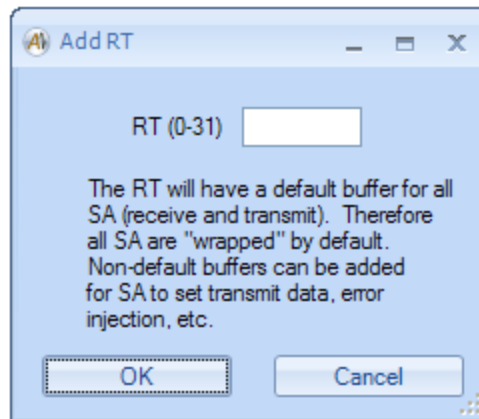

Enter the desired RT address (0-31) and click on the “OK” button. This will create an RT using the default buffers (all receive and transmit SA use the same buffer so all SA are “wrapped”). Repeat this process to add more RTs.

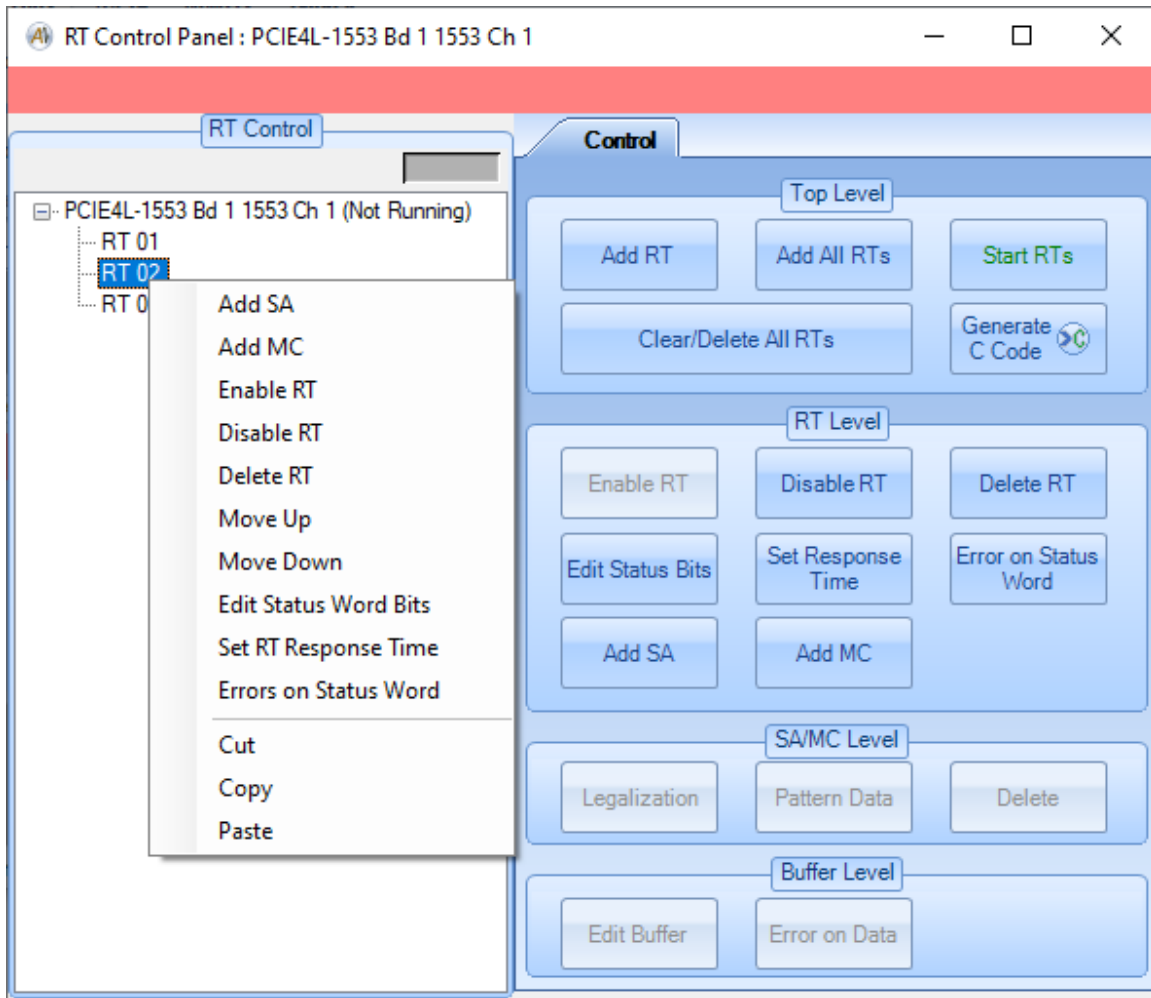

You can right-click on a RT node to bring up a menu of RT-level options. “Add SA” allocates non-default buffers by subaddress. “Add MC” allocates non-default buffers by mode code. “Enable RT” enables the RT to respond on the bus (the RT is enabled by default when it is added). “Disable RT” disables the RT so it will not respond on the bus (disabled RTs will be shown in light gray). The “Delete RT” option will remove the RT from the tree and will free all resources associated with the RT. The “Move Up” and “Move Down” options allow you to re-order the RT nodes in the tree. “Edit Status Word Bits” will bring up a dialog box that displays the status word and allows you to change it. “Set RT Response Time” brings up a similar dialog box for status response time. “Errors on Status Word” will bring up a dialog-box to define error injection options on the RT status word. Double-clicking on a RT node will bring up the “Edit Status Word Bits” dialog.

The “Cut” option will copy the subaddresses and mode codes of the RT into an internal buffer and then delete the RT entry, the user will be prompted before

deleting the RT. “Copy” does that same without deleting the RT entry. Choosing the “Paste” option will add in subaddress and mode code entries under that RT that are in the internal buffer from a previous “Cut” or “Copy” operation. Existing subaddresses and mode codes will be ignored.

If you select “Add SA” you will see the following dialog-box:

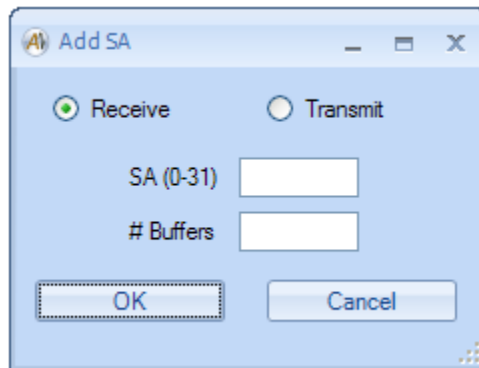

Select receive or transmit, select the subaddress number (0-31), and select the number of buffers to allocate for the SA. If more than one buffer is defined, they will be allocated as a circular linked-list – the buffers will be used in order and will start over with the first buffer when all buffers have been used.

If you select “Add MC” you will see the following dialog-box:

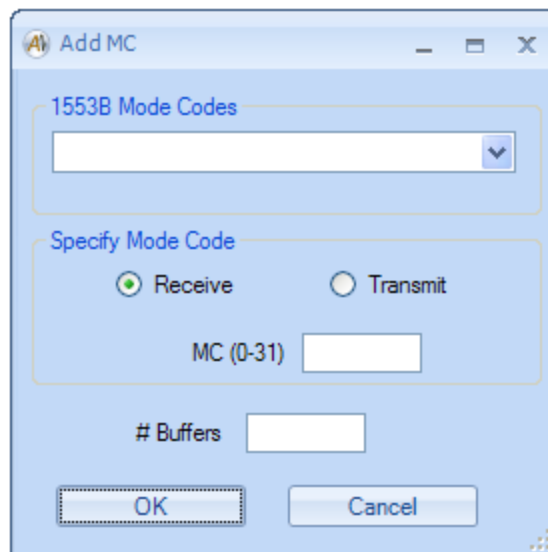

You can select standard 1553B mode codes from the combo-box or specify a mode code by receive/transmit and mode code number. You can also select the

number of buffers to allocate for the MC. If more than one buffer is defined, they will be allocated as a circular linked-list – the buffers will be used in order and will start over with the first buffer when all buffers have been used.

If you select “Edit Status Word Bits” you will see the following dialog-box:

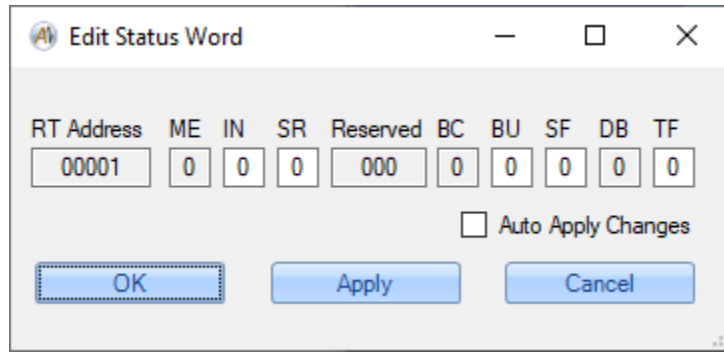

Some fields in the status word cannot be changed – these are RT Address, ME, Reserved, BC and DB shown in gray and are read-only. The other bits can be set to 1 or 0, these fields will toggle between 1 and 0 when clicked. If the “Auto Apply Changes” check box is set then any changes to the status bits will be applied as soon as they are clicked without having to also click the “Apply” or “OK” buttons. The “OK” button will apply the changes and close the dialog. The “Apply” button will apply the changes and keep the dialog open. The “Cancel” button closes the dialog without applying the changes unless the “Auto Apply Changes” check is checked since those changes are applied as soon as they are clicked.

If you select “Set RT Response Time” you will see the following dialog-box:

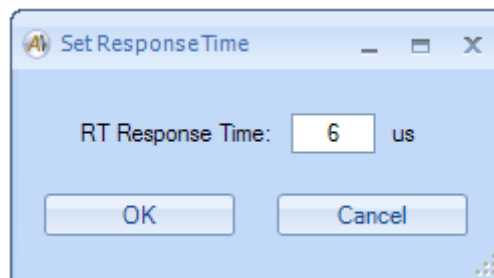

This lets you assign the RT status response time (in microseconds).

If you select “Errors on Status Word” you will see the following dialog-box:

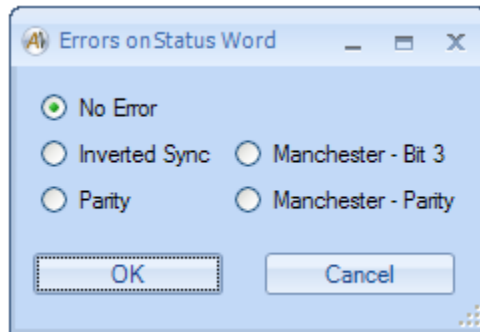

Select the desired error to inject on the RT status word using this dialog-box. The error will occur on EVERY status word sent by the RT.

After adding SA or MC for the RT, you will have SA/MC and Buffer nodes in the RT Control tree.

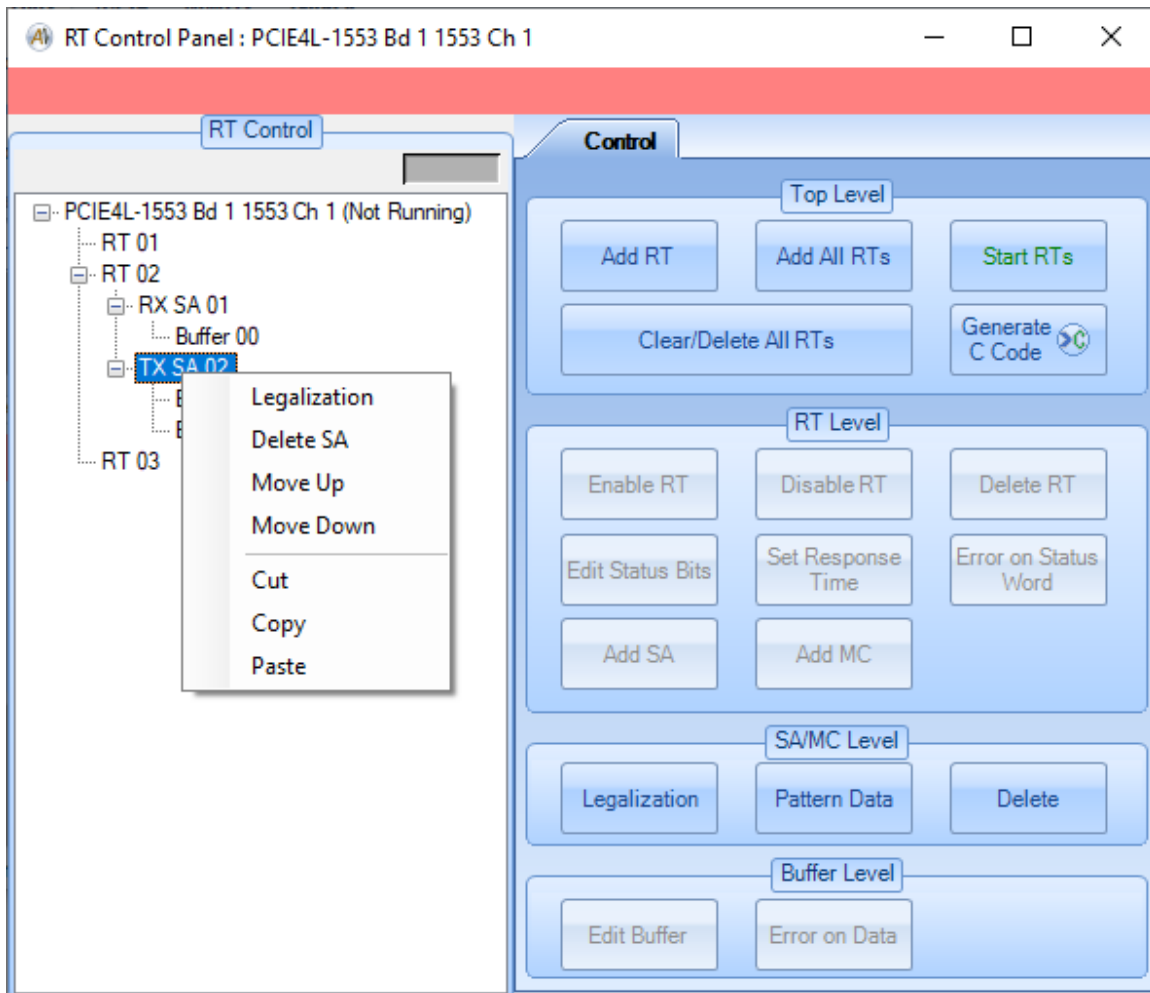

Right-clicking on a SA or MC node will give you the options “Delete SA”/“Delete MC”, “Move Up”, “Move Down”, and “Legalization”. “Delete SA”/“Delete MC” removes the SA/MC from the tree and frees all resources associated with the SA/MC. The “Move Up” and “Move Down” options allow you to reorder the SA/MC nodes in the tree. Double-clicking on a SA/MC node will bring up the “Legalization” dialog. The “Cut” option copies the selected SA/MC into an internal buffer and then delete the SA/MC, the user will be prompted to confirm the deletion of the SA/MC. “Copy” copies the selected SA/MC into the internal buffer without deleting it. “Paste” adds an SA or MC entries in the internal buffer as sibling entries if they do not already exist under the parent RT node.

The “Legalization” option brings up a dialog-box to define the legal word counts for the subaddress.

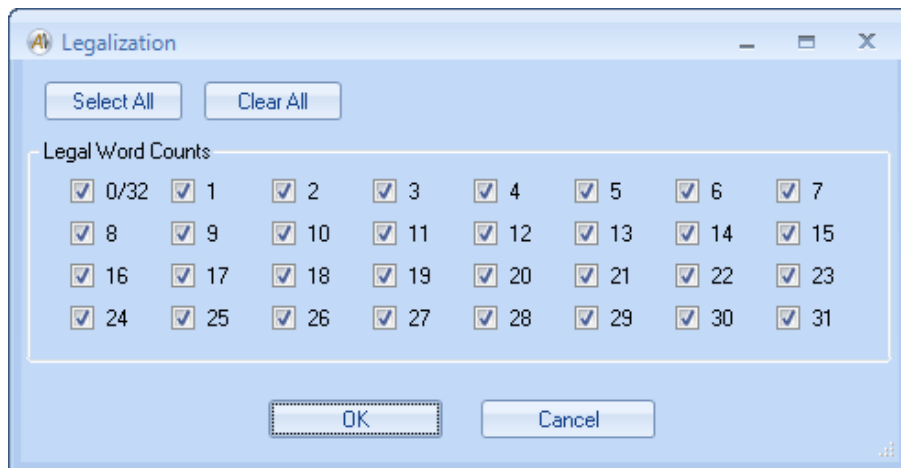

If the box is checked for a given word count, then that word count is legal. Unchecked word counts are illegal.

The “Pattern Data” button is enabled only if you have selected a TX SA with multiple buffers and the device is enabled for full analyzer operation. This is used to load a set of multiple data buffers with a pattern of data, rather than manually editing each buffer. This button gives you a dialog box to define the data word and data pattern to apply.

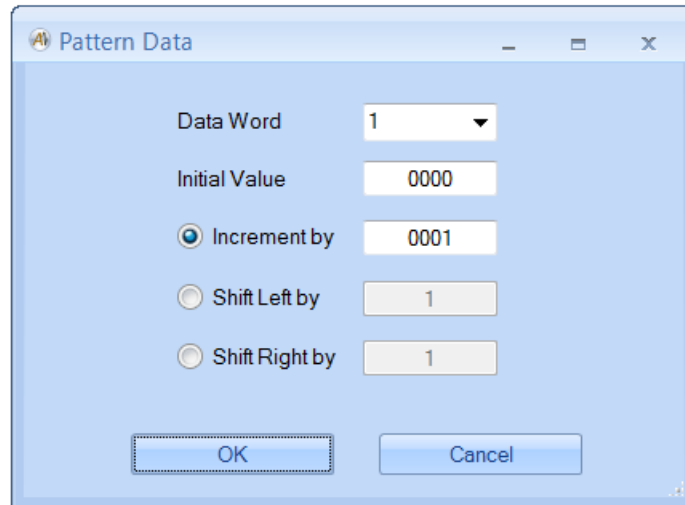

The supported patterns are Increment, Shift Left, and Shift Right. Each time you apply a data pattern it effects one data word. You could do this multiple times to define different data patterns to different words.

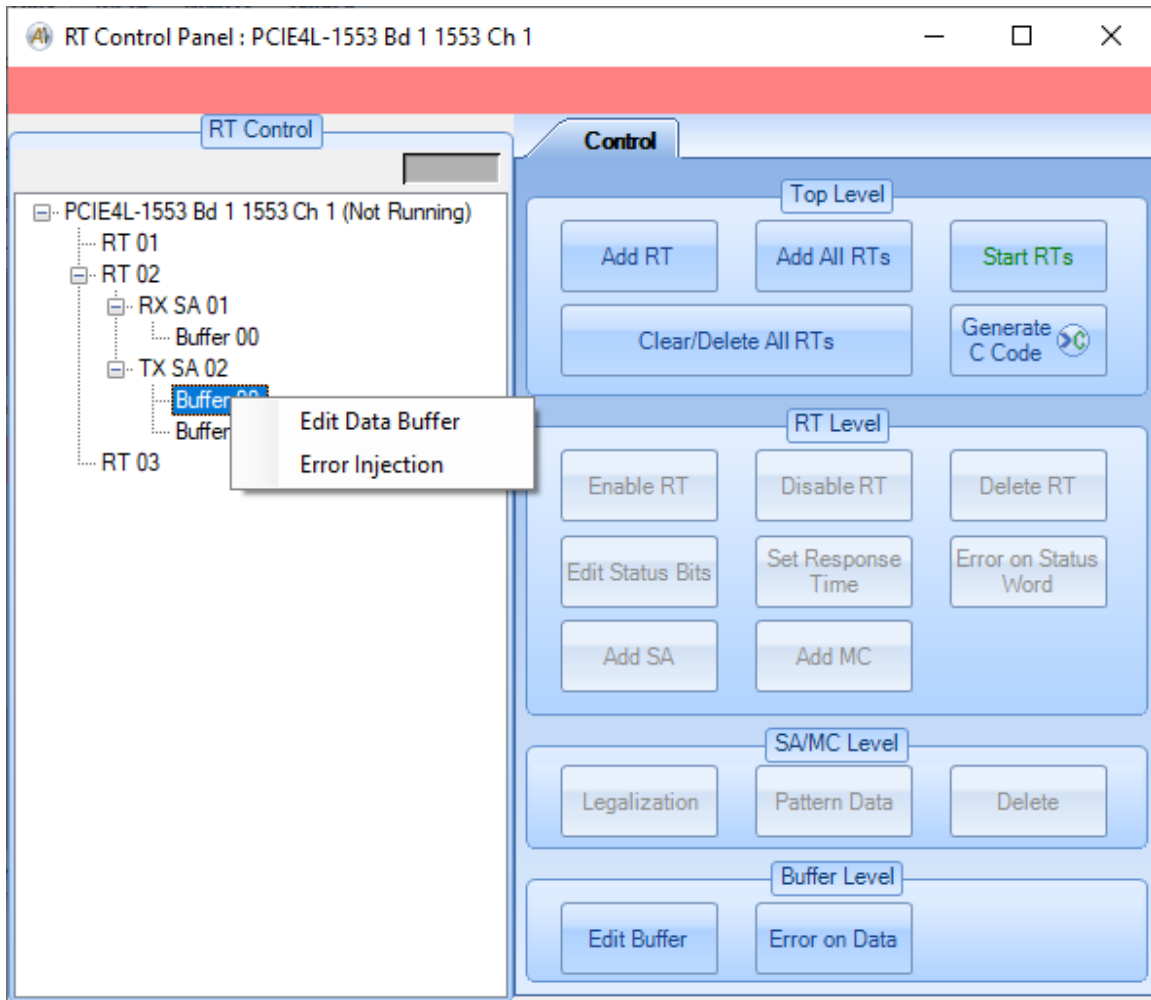

Right-clicking on a Buffer node will give you the options “Edit Data Buffer” and “Error Injection”. Note that the “Error Injection” option is only provided for Transmit buffers. Double-clicking on a Buffer node will open the “Edit Data Buffer” dialog for that buffer.

If you select “Edit Data Buffer” this will bring up a dialog-box that displays the current data words in the buffer and gives you the option to change them.

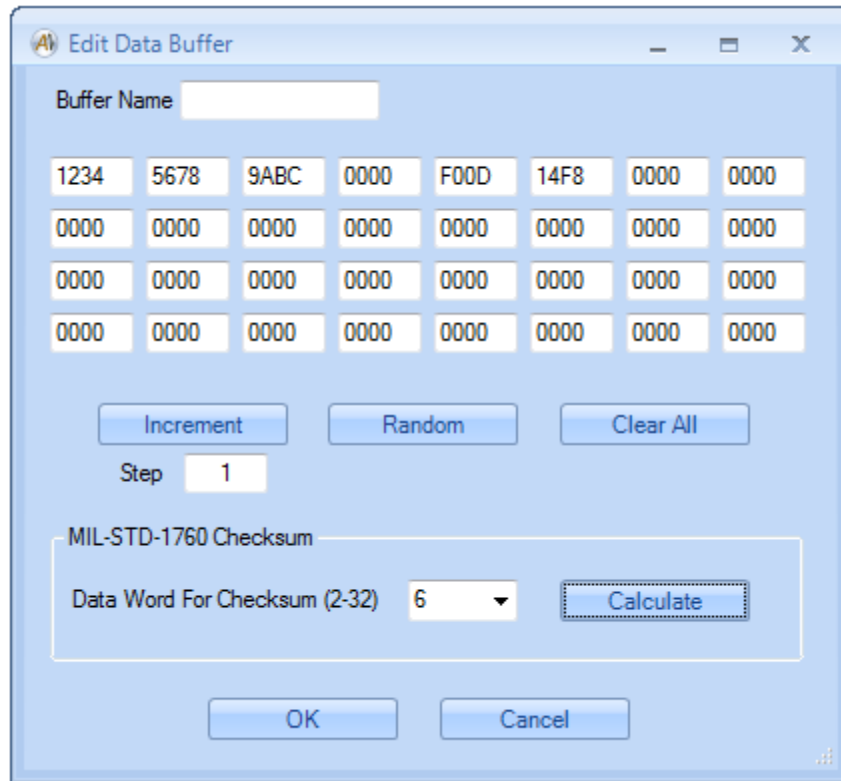

The “Increment” button starts with the first data word and sets all other data words to an incrementing pattern (increments each data word by the Step value) – if the Step value is 1 and the first data word is AB00, then the other data words will be set to AB01, AB02, AB03, etc. The “Random” button sets all data words to random values. The “Clear All” button sets all data words to 0000. The “MIL-STD-1760 Checksum” box allows you to select a data word (2-32) to contain the checksum – when you click the “Calculate” button all previous data words will be used to calculate the MIL-STD-1760 checksum (as per MIL-STD-1760C, Appendix B, section B.4.1.5.2.1) and the result will be shown in the selected data word.

The “Buffer Name” field gives you the option to define a text string for the buffer that will be displayed in the RT Control Panel tree.

If you select “Error Injection” this will bring up a dialog-box that displays the current error injection settings for the buffer and gives you the option to modify them.

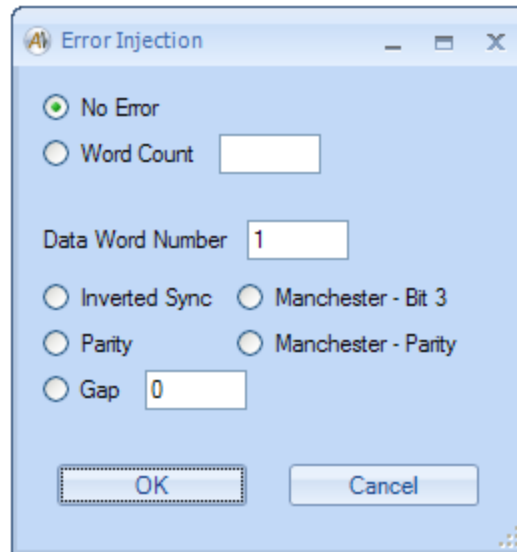

If a word count error is selected, you will enter the actual number of words to transmit in the text box to the right of the “Word Count” radio-button. This must be a value from 0 to 62.

If a word-level error is selected, you will enter the data word number to inject the error on. This must be a value from 1 to 32.

If a gap error is selected, you will enter the gap time in microseconds. This is a floating-point value with a resolution of 0.1 microseconds (100 nanosecond LSB). This must be a value from 0 to 25.5. This gap will be injected before the selected data word.

Start RTs

The “Start RTs” button will start Remote Terminal operation for the selected 1553 device. This button does not activate any other forms or windows.

Stop RTs

The “Stop RTs” button will stop Remote Terminal operation for the selected 1553 device. This button does not activate any other forms or windows.

Bus Controller Tools

The Bus Controller tools provide controls for BC operation. The 1553 Bus Controller allocates memory on the device for a maximum of 1024 BC messages. **For dual-function devices the operator will be prompted to open the device in either Remote Terminal or Bus Controller mode. If BC mode is chosen, the Remote Terminal Tools are disabled and the device must be closed, then reopened to switch to RT mode.**

BC Control Panel

The “BC Control” button will bring up the BC Control Panel for the selected 1553 device. This is the main window for all Bus Controller operations for the device. **If the device is not enabled for full analyzer operation, the Message Enable/Disable, Trigger In/Out, Error on Command, Pattern Data, and Error on Data features are disabled.**

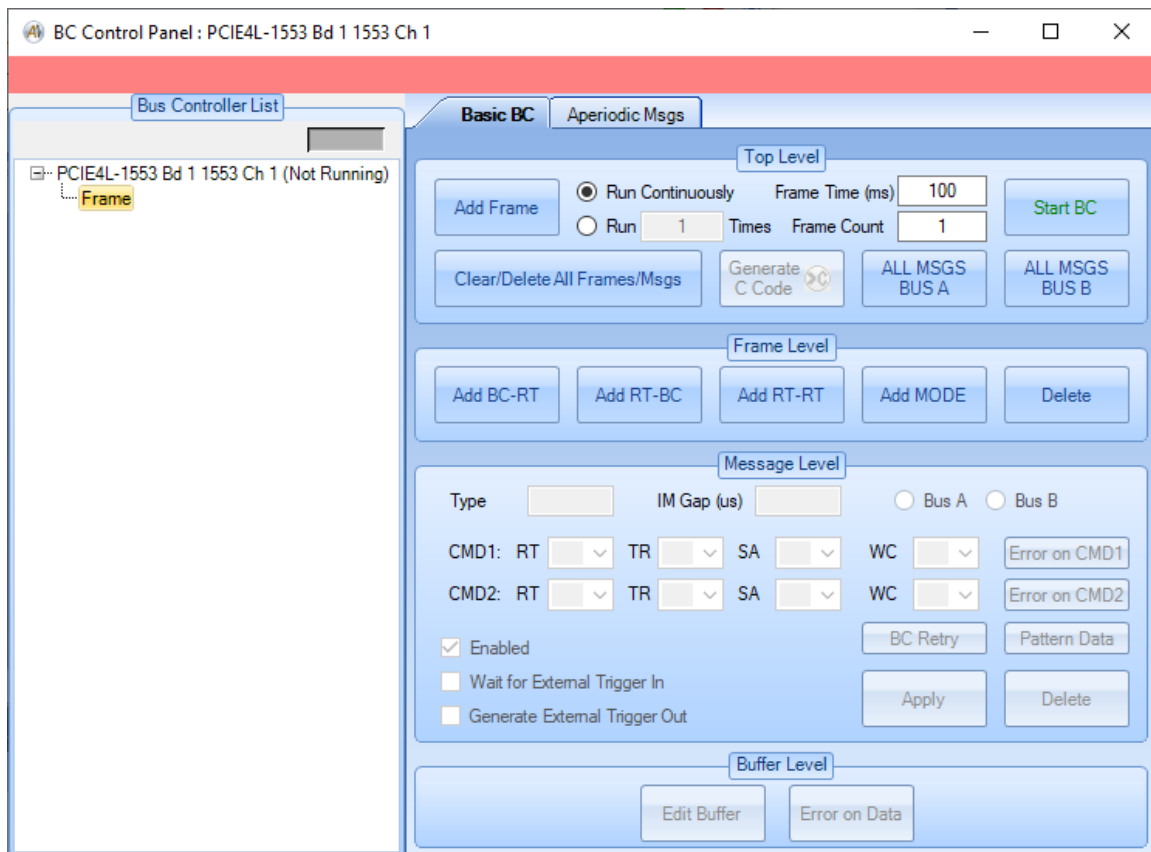

The BC Control Panel provides a tree-view on the left that displays the BC message list. Controls are provided on the right. The controls are organized by functional level – top level, frame level, message level, and buffer level.

This provides a “Basic BC” (thus the tab labeled “Basic BC”) that can send a list of messages within one or more frames. Advanced BC controls like multiple frequency messages, minor frame scheduling, etc. are not provided in *AltaView* and the user should use the Alta API to write their own programs using these features.

When the BC Control Panel is opened with no BC message list defined, *AltaView* automatically creates an empty Frame node for you. If you click on this frame node the frame-level controls will be enabled. You can use the frame-level buttons to add messages to the frame.

When you click one of the four buttons to add a message, you will see the following dialog box:

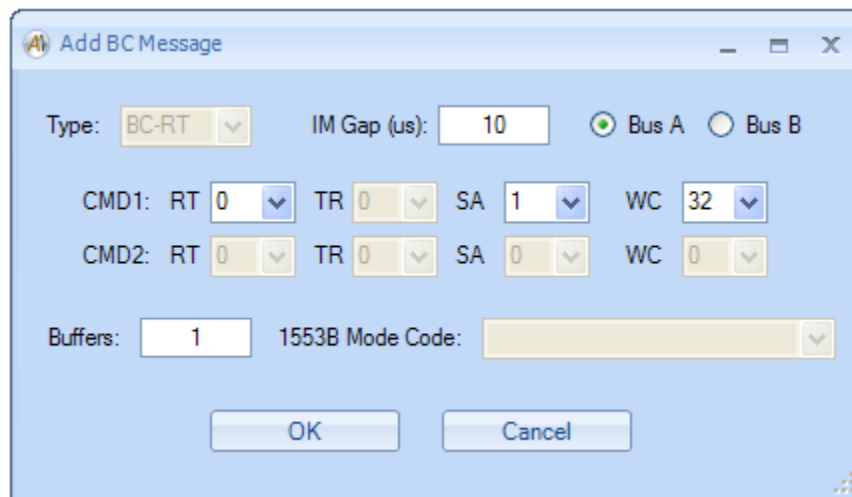

Appropriate fields are enabled or disabled based on the selected message type (BC-RT, RT-BC, RT-RT, or MODE). For MODE messages, a combo-box is provided to select standard 1553B mode codes. You can set the inter-message gap (time from the end of the previous message to the start of this message). You can select the bus for the message (bus A or bus B). You can also specify the number of BC buffers to allocate for the message.

Once you have created messages, the tree will show frames, messages, and buffers. Clicking on a node in the tree enables the appropriate buttons on the right side of the BC Control Panel.

The “Aperiodic Msgs” tab can be used to define aperiodic message lists that can be injected into the regular (periodic) message list while the BC is running.

BC Control Panel – Basic BC – Top Level

The following shows what the BC Control Panel looks like at the top level:

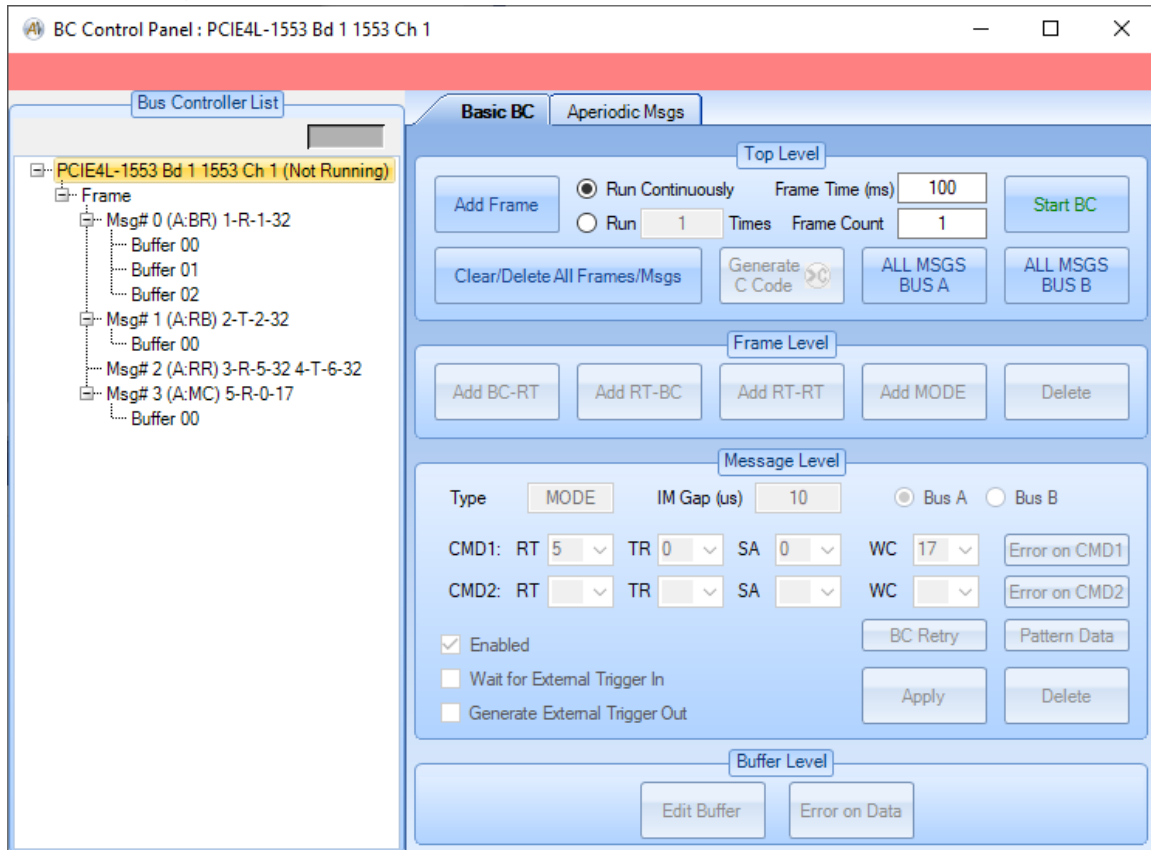

The top level controls allow you to configure the BC to run continuously or run a specified number of frames, set the frame time, add frames to the BC list, and start or stop the BC. The frame time can be a real number rather than an integer – for example, you can set a frame time of 12.5 milliseconds to get an 80 Hz frame rate. If “Run Continuously” is selected the BC will run the list repeatedly until stopped. If “Run” is selected, the BC list will send the number of frames specified by the text box and the BC will stop. The frame time is in units of milliseconds. When the BC is running the “Frame Count” will show the number of frames that have been executed.

The “ALL MSGS BUS A” button will set all messages in the main BC message list to be transmitted on Bus A.

The “ALL MSGS BUS B” button will set all messages in the main BC message list to be transmitted on Bus B.

The “Delete All Frames/Msgs” button clears the main BC message list and also clears all Aperiodic message lists. This button completely resets the Bus Controller object.

The “Generate C Code” button creates a C example program file from the Bus Controller List BC messages, the user will be prompted for the output file name. The generated file can be built using the instructions for building example programs in the AltaAPI User’s Manual. The generated C example program will include any Aperiodic Messages defined on the “Aperiodic Msgs” tab as well.

BC Control Panel – Basic BC – Frame Level

If a frame node is selected, the frame level controls will be enabled.

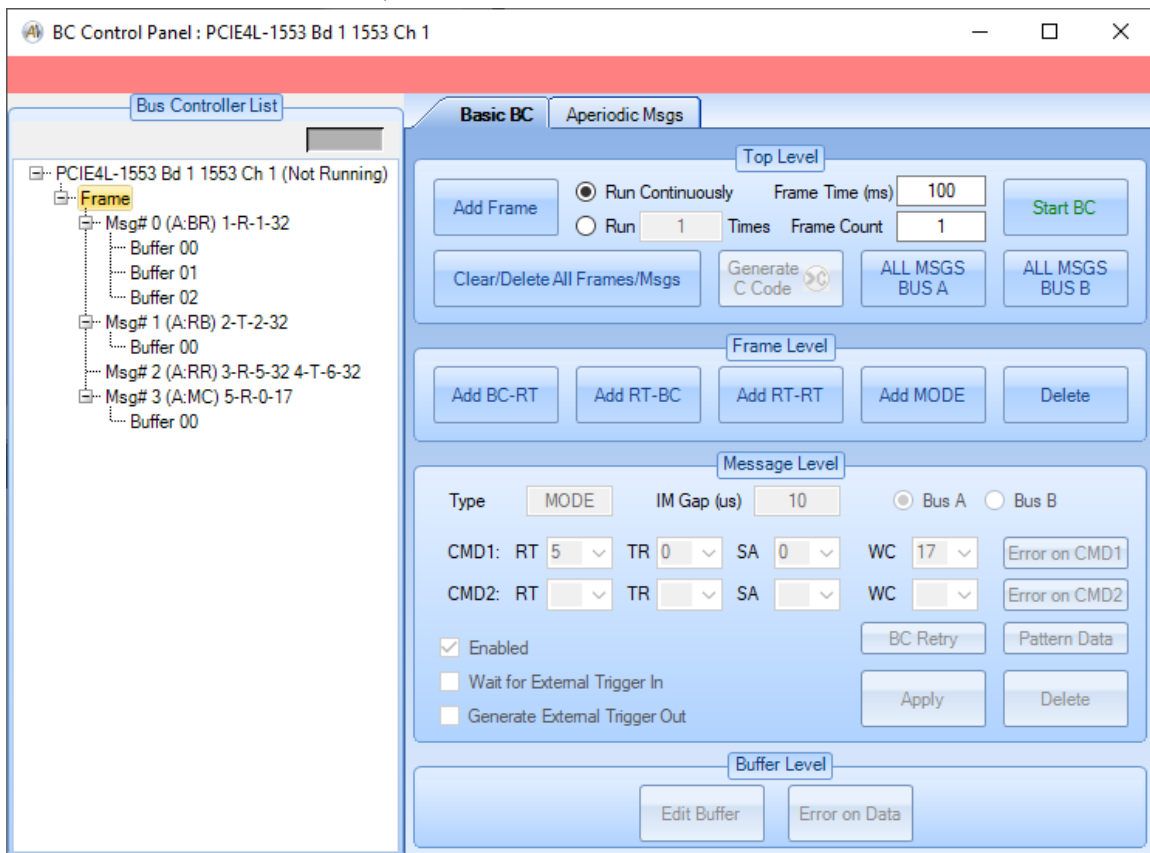

The frame level controls allow you to add messages to the frame or to delete the selected frame.

BC Control Panel – Basic BC – Message Level

If a message node is selected, the message level controls will be enabled.

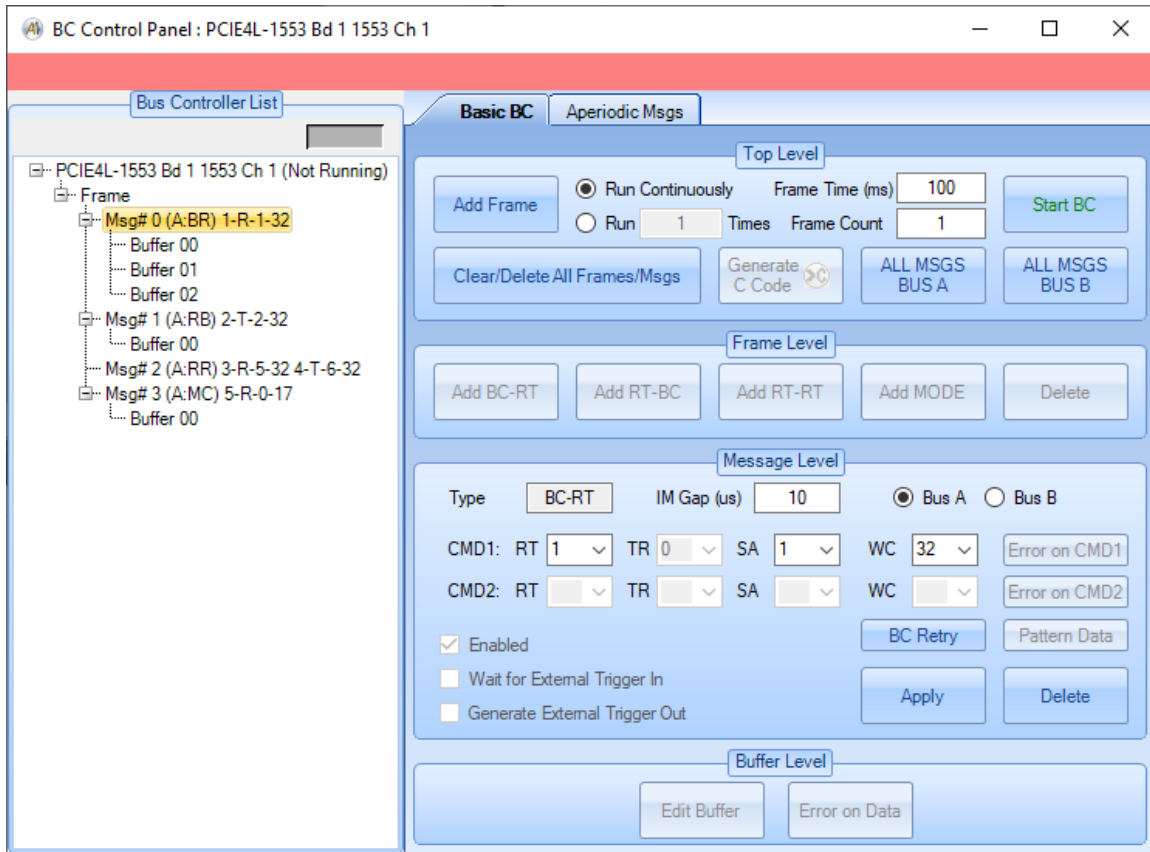

The message level controls allow you to edit or delete the selected message. ***If you edit the message, your changes do not take effect unless you click the “Apply” button.***

The “BC Retry” button opens a dialog that allows you to set retry options on the message.

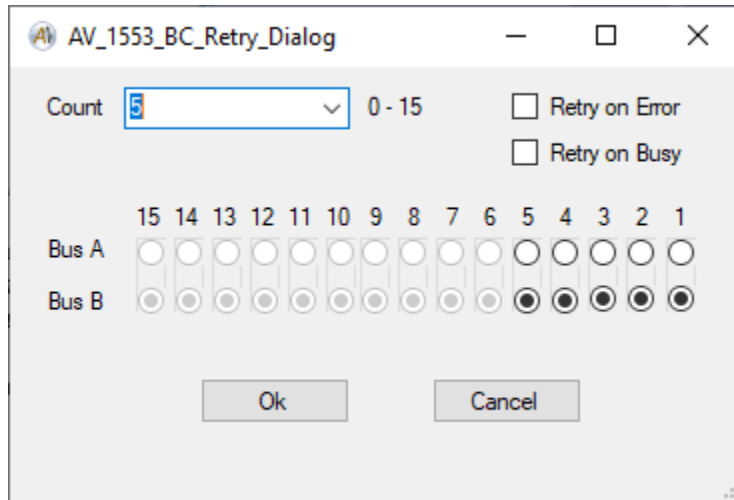

The “Count” combo selection allows you to choose how many retries will be attempted before the message is no longer sent. Two check boxes select on what condition the retry will occur, “Retry on Error” and “Retry on Busy”. The “Retry on Error” will resend the message as long as an error on it is detected, the “Retry on Busy” will retry the message if the RT returns a “Busy Bit” value of 1 in its status word. If neither of these is checked, no retries will occur regardless of the “Count” value selected. Also, if the “Count” is set to zero no retries will occur regardless of the checked state of the check boxes. The radio buttons below indicate on which bus the retry attempts will be made.

The “Pattern Data” button is enabled only if you have selected a BCRT message with multiple buffers and the device is enabled for full analyzer operation. This is used to load a set of multiple data buffers with a pattern of data, rather than manually editing each buffer. This button gives you a dialog box to define the data word and data pattern to apply.

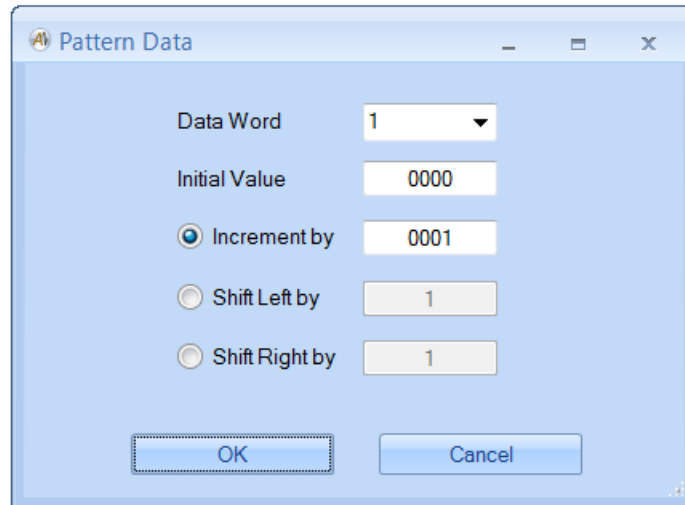

The supported patterns are Increment, Shift Left, and Shift Right. Each time you apply a data pattern it effects one data word. You could do this multiple times to define different data patterns to different words.

BC Control Panel – Basic BC – Buffer Level

If a buffer node is selected, the buffer level controls will be enabled.

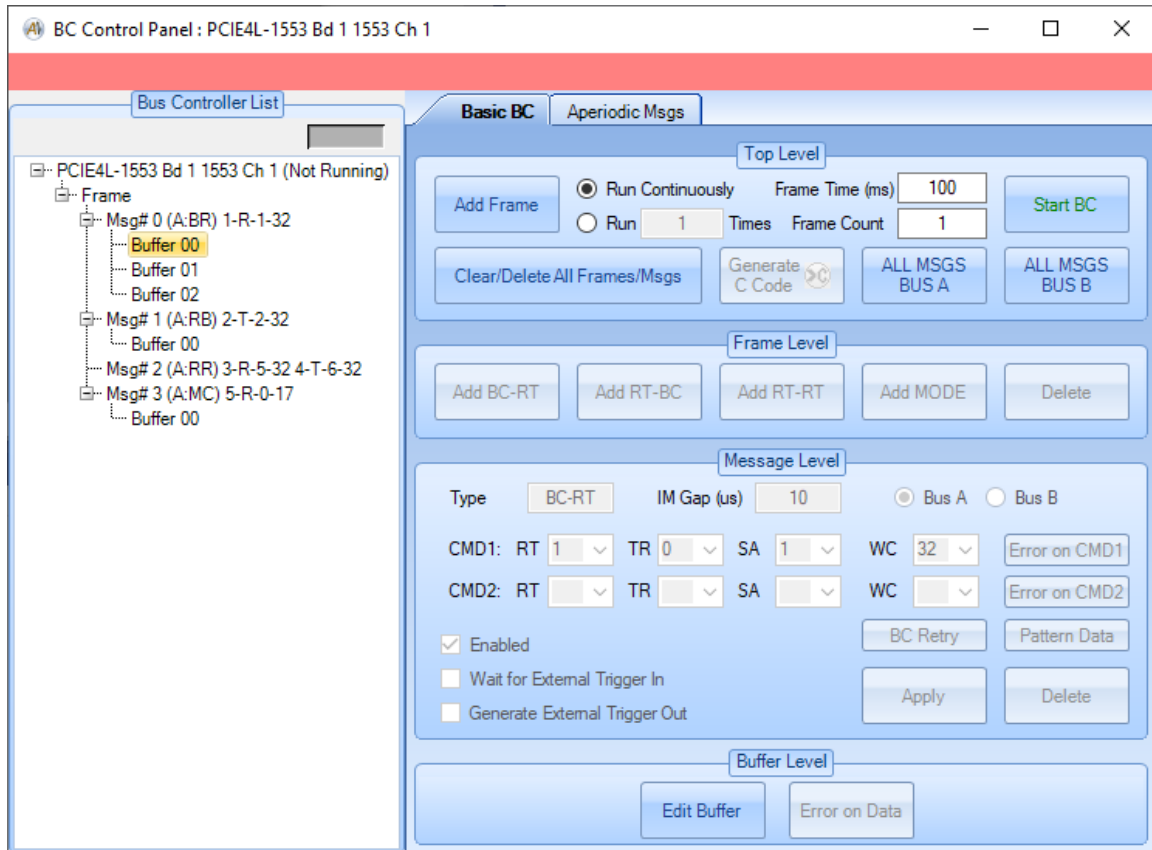

The buffer level controls allow you to edit the selected buffer and (for BC-RT buffers) inject errors in the buffer. Double-clicking on a Buffer node will open the “Edit Data Buffer” dialog for that buffer.

If you click on the “Edit Buffer” button you will see the following dialog box:

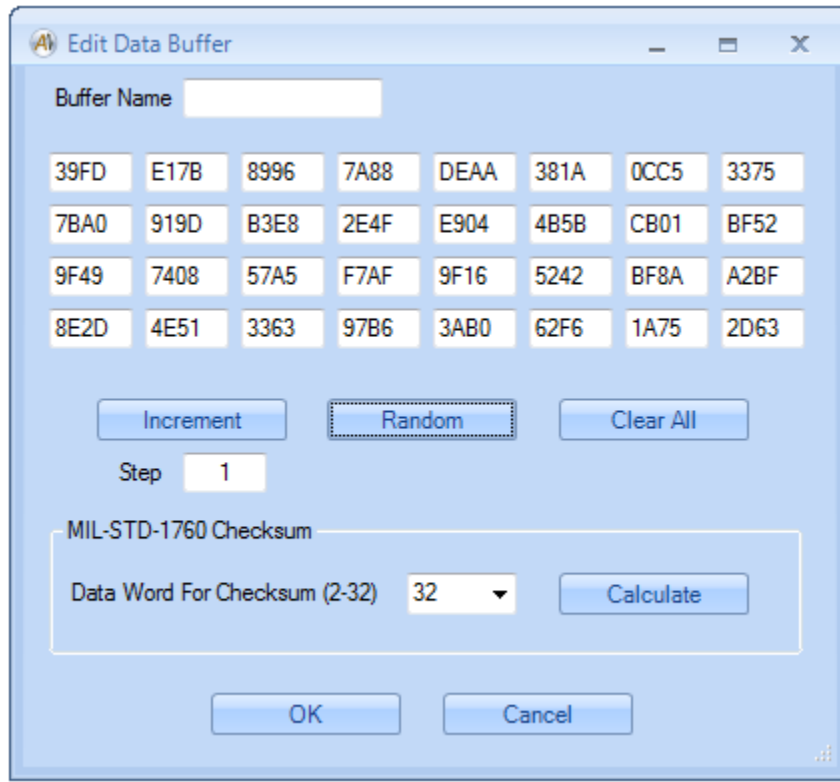

This allows you to change the data word values. The values are in hexadecimal format. The “MIL-STD-1760 Checksum” box allows you to select a data word (2-32) to contain the checksum – when you click the “Calculate” button all previous data words will be used to calculate the MIL-STD-1760 checksum (as per MIL-STD-1760C, Appendix B, section B.4.1.5.2.1) and the result will be shown in the selected data word.

The “Buffer Name” field gives you the option to define a text string for the buffer that will be displayed in the BC Control Panel tree.

If you click on the “Error on Data” button you will see the following dialog box:

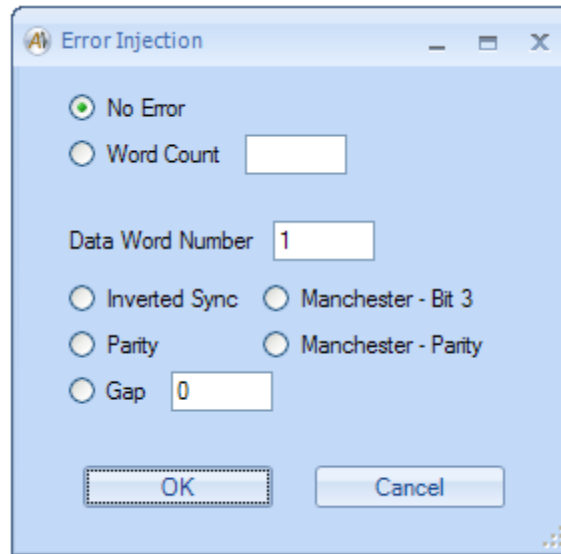

This is identical to the Error Injection dialog box used with RT buffers.

BC Control Panel – Basic BC – Bus Controller List

A context menu in the Bus Controller List allows for the Cut, Copy and Paste of items in the list. Right clicking on an item will display the context menu as shown below:

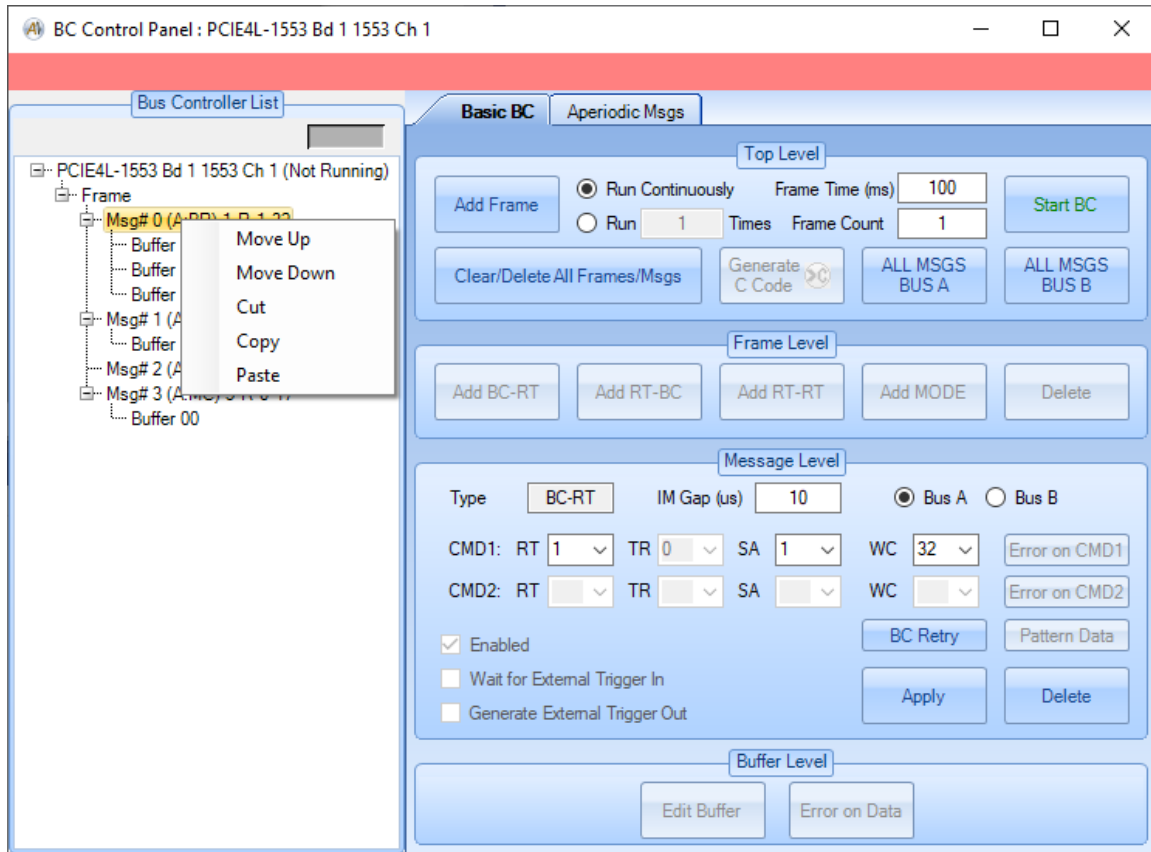

Copy creates a copy of the item in an internal clipboard to the dialog. Only Frames, messages and buffers can be copied, the root board node cannot be copied.

Cut is similar to copy except that upon its selection the item is deleted, once deleted it cannot be recovered. The top-level board node cannot be cut, also the last frame in the list or the last buffer of a message cannot be cut.

Paste creates a new copy of the previous cut or copied item. The paste operation can be repeated to continue to create new copies of the item. The rules for pasting are as follows, an item can be pasted to a node of the type one level above the cut/copied item, in this instance the new item is pasted in the first position following the item on which it was pasted. For example, if a message is copied and then pasted onto a frame the new copy will be created as the first

message of that frame. A message cannot be pasted on the root board level or on a buffer.

Also, an item may be pasted on an item of the same type, when this is done it will be copied immediately following the item. Thus, if a message is pasted on another message a new message will be created after the message it was pasted to.

Copy/Cut on a frame will copy all messages with in the frame. A BC-RT and RT-BC message buffer can be copied with the message it was copied from or to another BC-RT or RT-BC message, it cannot be copied to a Mode Code message, likewise Mode Code buffers can only be copied to other Mode Code messages, not to a BC-RT or RT-BC message.

BC Control Panel – Aperiodic Msgs – Top Level

The following shows what the BC Control Panel looks like for the Aperiodic Msgs tab at the top level:

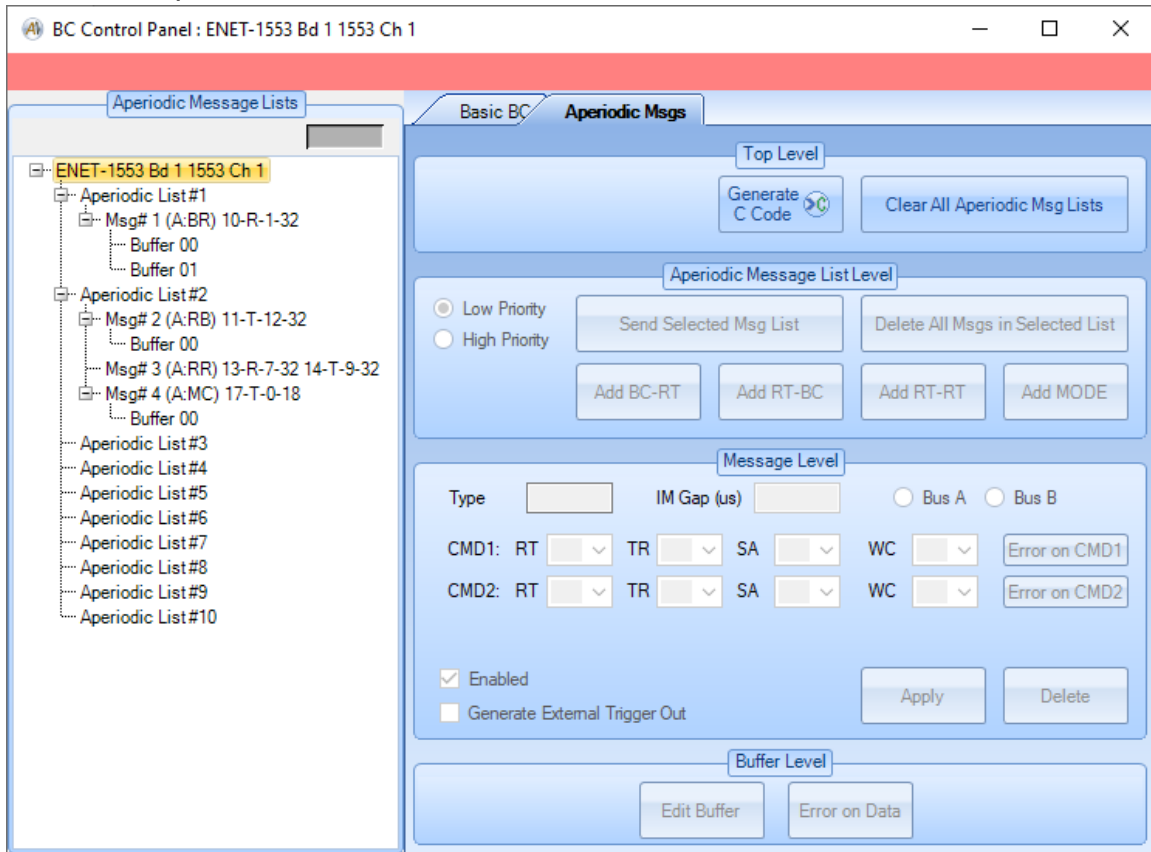

The top level aperiodic message controls allow you to clear all the Aperiodic Message lists.

The Generate C Code button calls the same C example creating code which includes the messages defined on the Basic BC and Aperiodic Msgs tabs of this dialog (see the Generate C Code button description for the Basic BC tab above).

BC Control Panel – Aperiodic Msgs – Aperiodic List Level

If an Aperiodic List node is selected, the Aperiodic Message List Level controls will be enabled.

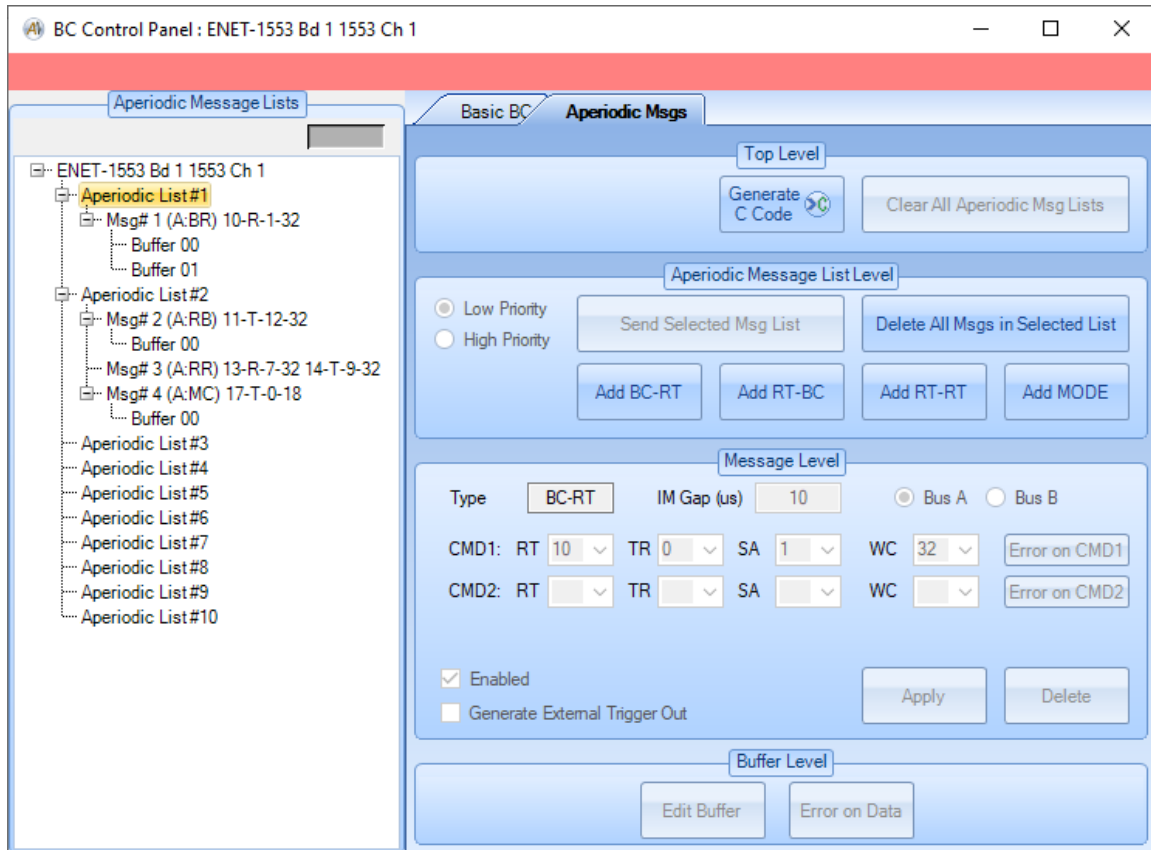

The frame level controls allow you to add messages to the aperiodic list, delete all messages in the selected list, or send the selected list. The radio buttons allow selection of either Low Priority or High Priority. If Low Priority is selected, then the aperiodic message(s) will be sent after the next FRAME completes. If High Priority is selected, then the aperiodic message(s) will be sent after the next MESSAGE completes.

Note that the Priority radio buttons and the “Send Selected Msg List” button are only enabled if the BC is running – aperiodic messages are injected into a RUNNING list of messages. You cannot send aperiodic messages if the BC is not running.

Right-clicking on an Aperiodic List entry will bring up a context menu with Cut, Copy and Paste options. Cut will copy all messages in the selected Aperiodic List into an internal buffer and then delete them all from the list. Copy will do the similar copy of the messages into the internal buffer without deleting them. Paste

will copy any messages in the internal buffer into the top of the currently selected Aperiodic List. Note subsequent Cut/Copy operations will over write the internal buffer with the newly selected messages.

BC Control Panel – Aperiodic Msgs – Message Level

If a message node is selected, the message level controls will be enabled.

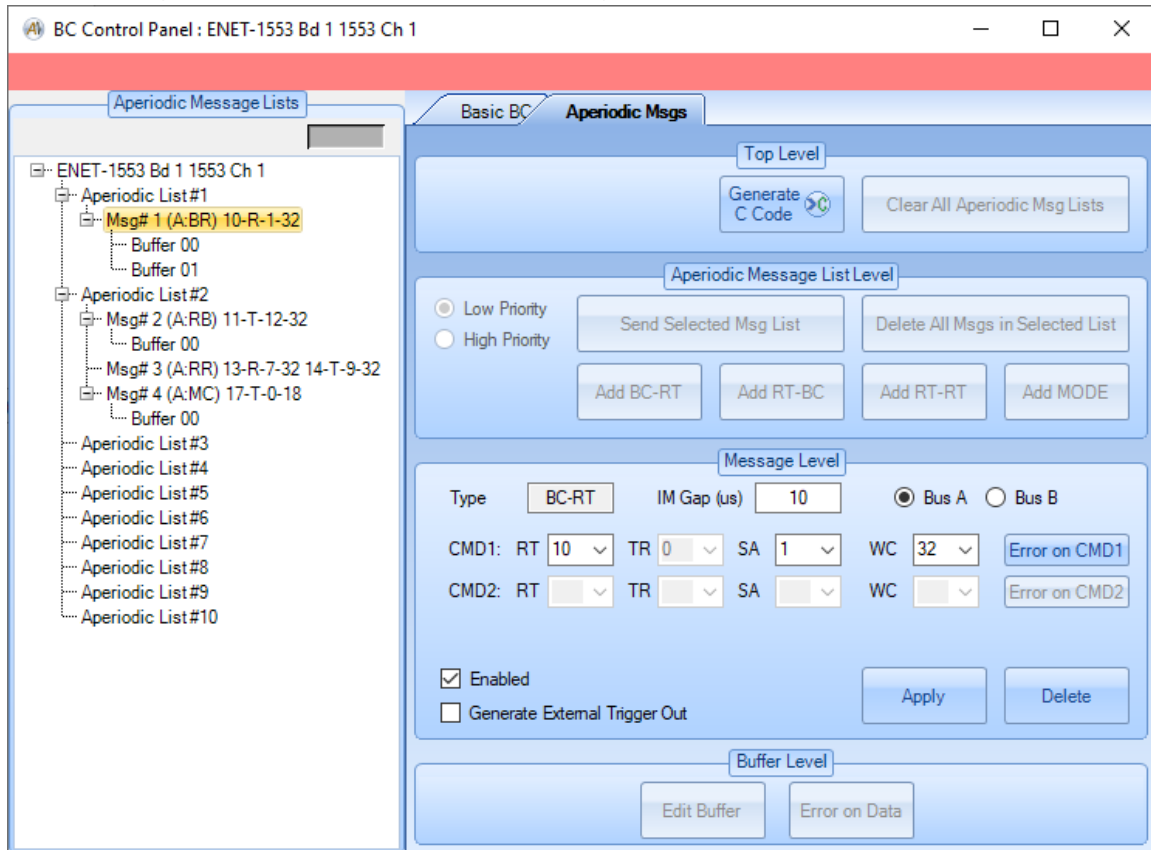

The message level controls allow you to edit or delete the selected message. ***If you edit the message, your changes do not take effect unless you click the “Apply” button.***

Right-clicking on a Message entry will bring up a context menu with Move Up, Move Down, Cut, Copy and Paste options. Selecting Move Up will move the message up entry in the currently selected list, if the message is already the first message in the Aperiodic List the operation is ignored. Move Down will move the message down one entry in the list, if the message is already the last message in the list the operation is ignored. Cut will copy the selected message into an internal buffer and then delete it from the list. Copy will copy the message into the internal buffer without deleting it. Paste will copy any messages in the internal buffer into currently selected Aperiodic List just below the currently selected message. Note subsequent Cut/Copy operations will overwrite the internal buffer with the newly selected messages.

BC Control Panel – Aperiodic Msgs – Buffer Level

If a buffer node is selected, the buffer level controls will be enabled.

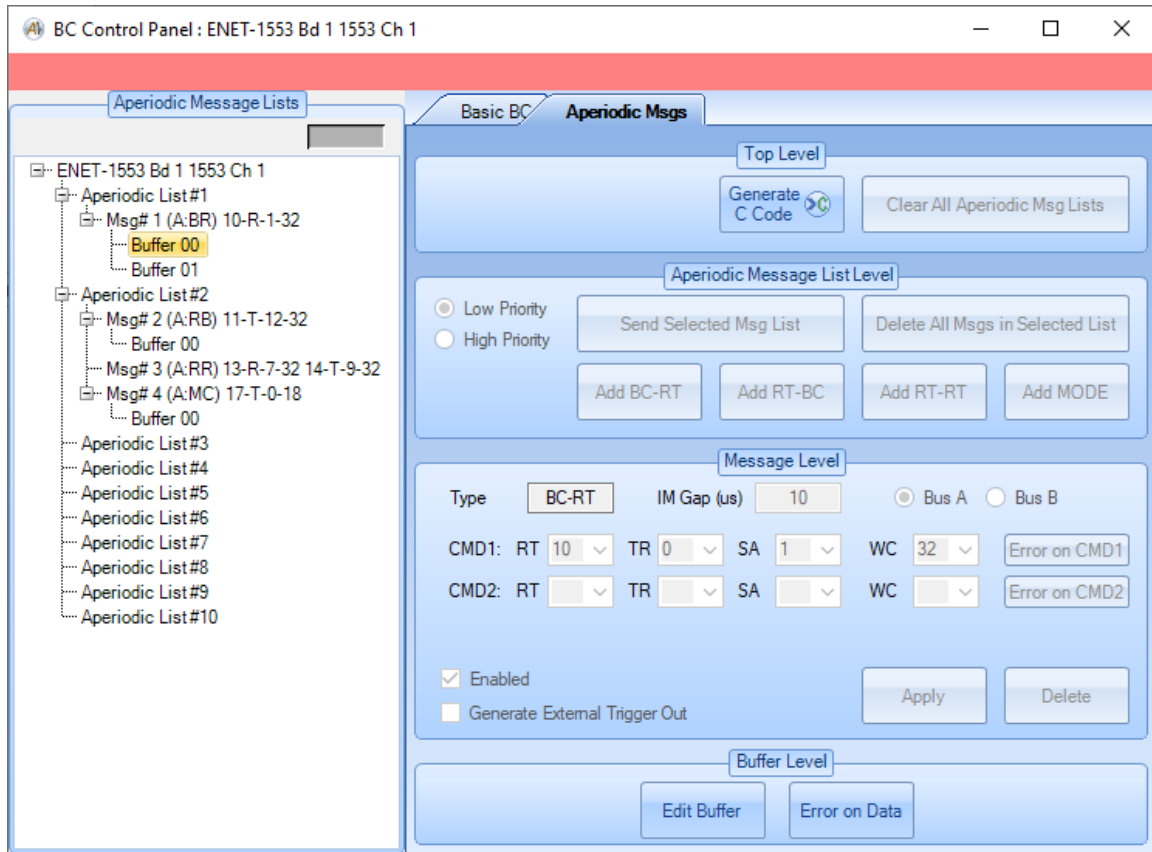

The buffer level controls allow you to edit the selected buffer and (for BC-RT buffers) inject errors in the buffer. Double-clicking on a Buffer node will open the “Edit Data Buffer” dialog for that buffer.

The “Edit Buffer” and “Error on Data” buttons function the same way on both the “Basic BC” tab and the “Aperiodic Msgs” tab.

Start BC

The “Start BC” button will start the Bus Controller for the selected 1553 device. This button does not activate any other forms or windows.

Stop BC

The “Stop BC” button will stop the Bus Controller for the selected 1553 device. This button does not activate any other forms or windows.

Playback Tools

The Playback tools provide controls for Playback operation. Playback allows **AltaView** to read CDP files (recorded by the Bus Monitor) and replay them onto the 1553 bus. **These tools are disabled if the device is not enabled for full analyzer operation.**

Note that playback is intended for “normal” messages without protocol errors – it is difficult to accurately playback messages with errors. Abnormal conditions, like broadcast RTBC messages for example (things like this occur in AS4111 RT validation testing), may be discarded as invalid CDP records and the message will be skipped by playback. **Messages with errors or abnormal conditions may play back inaccurately or may be skipped altogether.**

Playback Control

The “Playback Control” button will bring up the Playback Control Panel for the selected 1553 device. This is the main window for all Playback operations for the device.

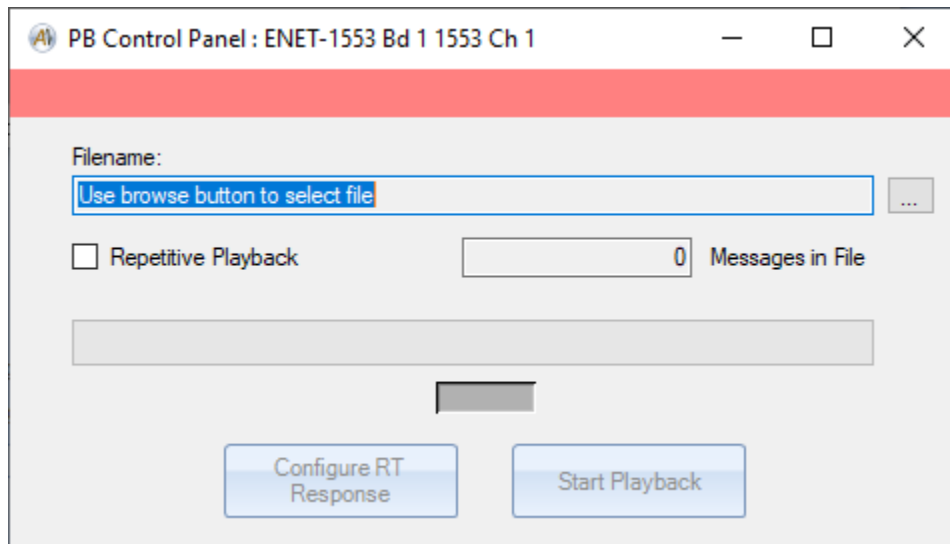

The “browse” button (located to the right of the Filename text-box) brings up a dialog-box that allows you to select a CDP file for playback. **YOU MUST SELECT A CDP FILE TO ENABLE THE CONTROLS IN THIS WINDOW.** When the file is loaded the number of messages (CDP records) in the file will be displayed.

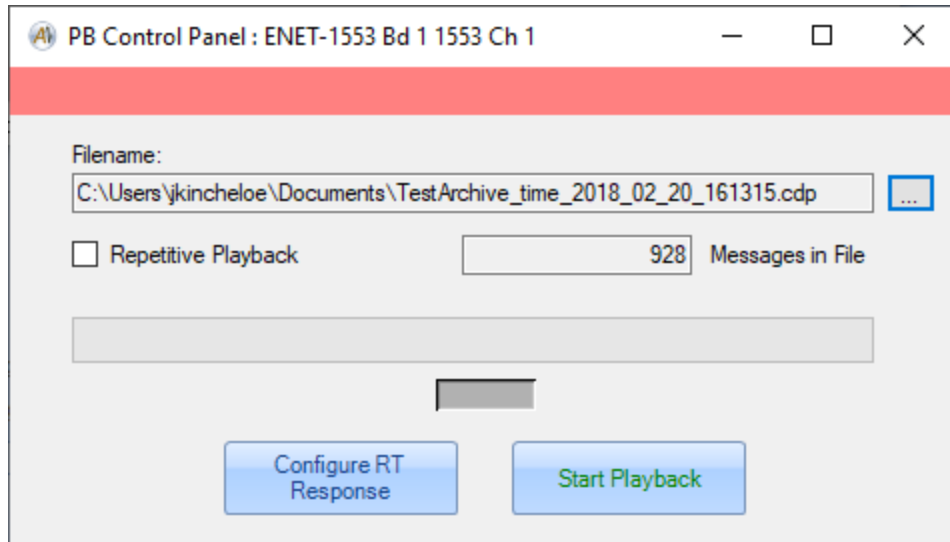

If you check the “Repetitive Playback” check-box then when playback is started it will run continuously, playing back the selected file repeatedly, until stopped by the user. If this is not checked, then the selected file will be played back only once and playback will stop when it reaches the end of the file.

The “Configure RT Response” button allows you to enable or disable playback of RT status/data words by RT address. This button brings up the following dialog-box:

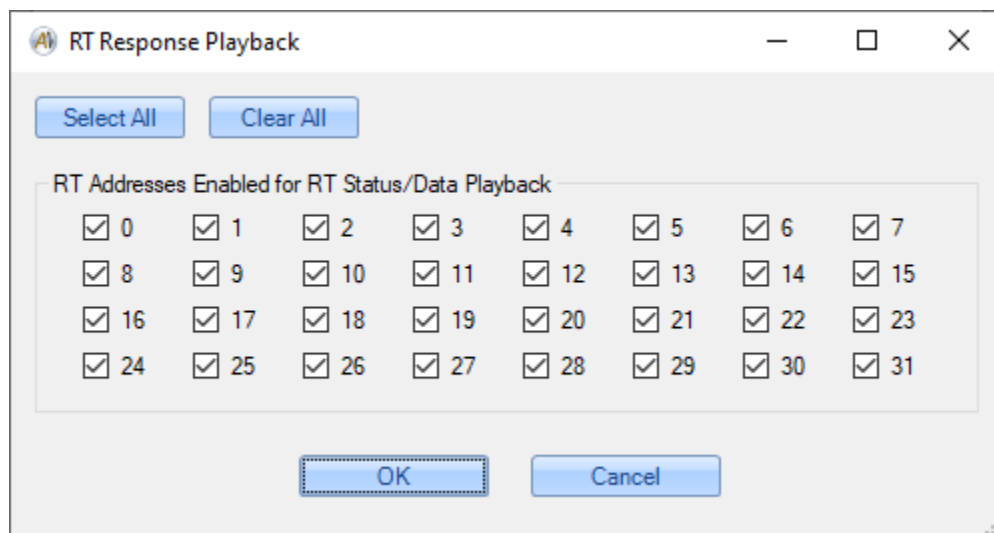

All RT addresses are enabled for playback by default. Check the RT address to enable playback of RT status/data words or uncheck the RT address to disable playback of RT status/data words. Click the “OK” button to apply the settings.

The “Start Playback” button will start transmission of messages on the 1553 bus. Once playback is started, this button changes to “Stop Playback” and if clicked again it will stop transmission of messages and reset playback to the beginning of the selected CDP file.

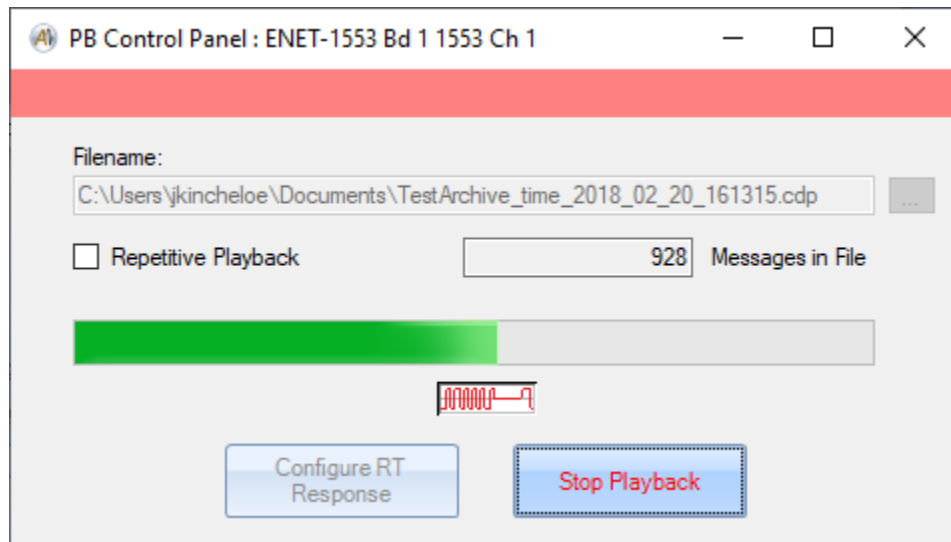

The progress bar and activity indicator in the middle of the window will show whether or not playback is running and will show how much of the file has been played back. If “Repetitive Playback” is not checked, then playback will automatically stop when the end of the CDP file is reached.

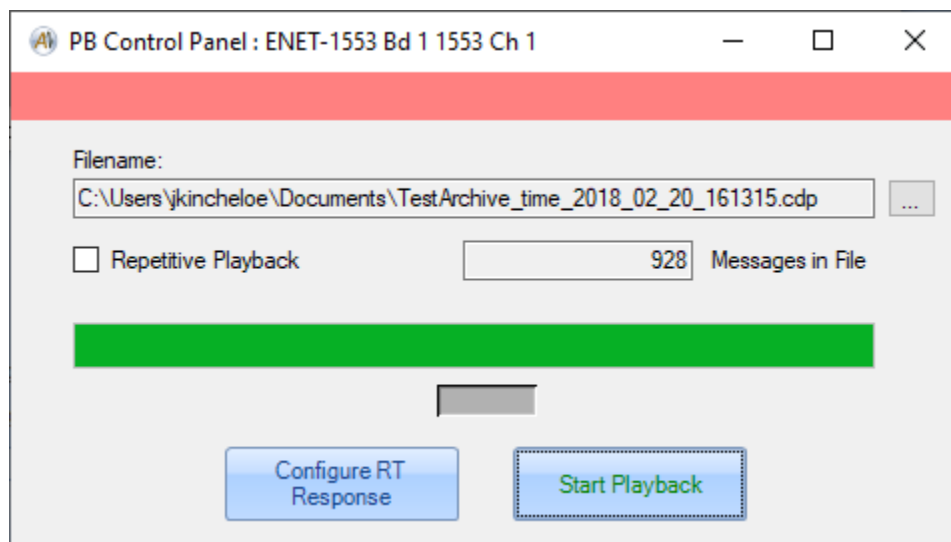

Note that you CANNOT run playback and the Bus Controller simultaneously. However, you CAN run Remote Terminals with playback (but you should disable

playback of RT status/data for any live RTs on the bus) and you CAN run the Bus Monitor with playback.

If the Playback Control Panel window is closed this will reset all playback settings and free all resources used by playback.

Start PB

The “Start PB” button will start Playback for the selected 1553 device. This button does not activate any other forms or windows. This is identical to the “Start Playback” button in the Playback Control Panel.

Stop PB

The “Stop PB” button will stop Playback for the selected 1553 device. This button does not activate any other forms or windows. This is identical to the “Stop Playback” button in the Playback Control Panel.

Synchronous Playback

Note that *AltaView* uses **Relative Timing** for playback – this means the first message in the CDP file is sent immediately when playback starts and the timing of subsequent messages is relative to the first message. Most users play back a single file and relative timing works well for this because there is no delay before the first message is sent.

When you are trying to play back two or more files with *AltaView* synchronous playback using relative timing this can skew the timing of messages between the channels. Let’s say you play back file 1 on 1553 channel 1 and you play back file 2 on 1553 channel 2. If the first message of both files originally occurred at the same time then you should not have any timing skew. However, if the first message of file 1 occurred at time X and the first message of file 2 occurred at time X+Y then there will be a skew of Y when the two files are played back by *AltaView*, because the first message of both files will be sent immediately when playback starts and the timing of all subsequent messages will be relative to the first message in that file. This may or may not be acceptable for a given application. If this is a problem for your application then do not use *AltaView* synchronous playback – an alternative would be to write your own program using the AltaAPI to implement playback with Absolute Timing. The **AltaAPI Users Manual** discusses relative and absolute timing in the section “**Playback Relative versus Absolute (AT) Time Options**”.

The EXTERNAL CLOCK feature can be used to perform synchronous playback on multiple 1553 channels and multiple boards. This allows multiple channels to start playback simultaneously and to stay synchronized because all channels use the same clock to drive the playback interval timer.

1. Configure the board-global external clock settings for all boards to be used in the synchronous playback. This is done by opening the “Global” device for the board and opening the Board-Global Control Panel – select the desired external clock options here. **DO NOT ENABLE THE OUTPUT CLOCK AT THIS POINT.**

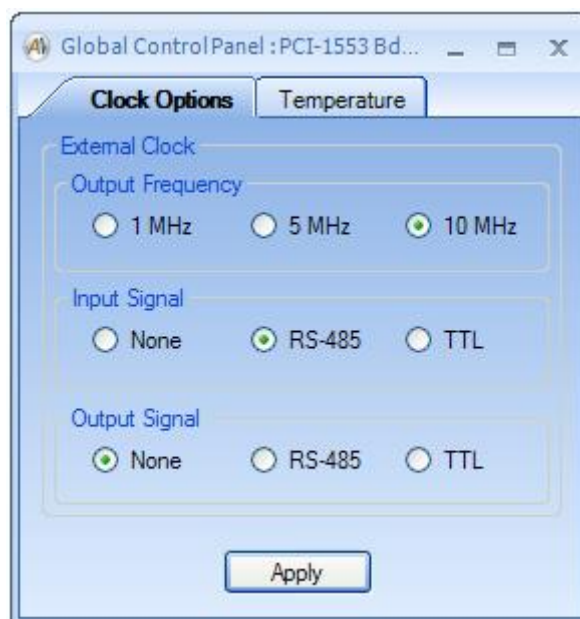

2. Configure the time options for all 1553 channels to be used in the synchronous playback. This is done by opening the 1553 channel device and opening the “Time Options” dialog-box for the device. Select the “External Clock” and select the clock frequency that matches the frequency of the external clock (selected in step 1 above).

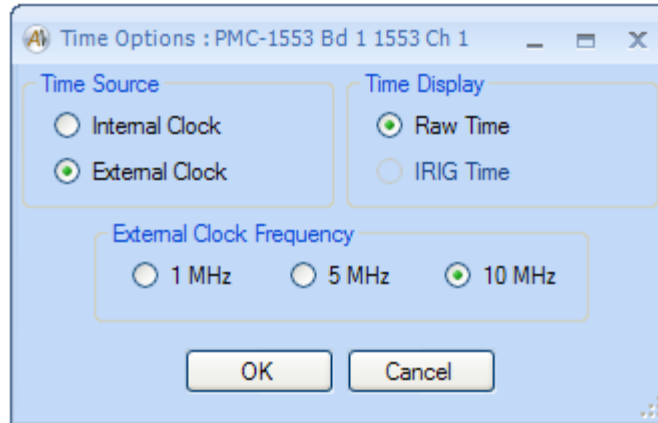

3. Configure playback for all 1553 channels to be used in the synchronous playback. This is done by opening the PB Control Panel for each channel, selecting the desired CDP file for playback, and clicking on the “Start Playback” button. **Note that playback will not start sending any messages until the external clock is started.**

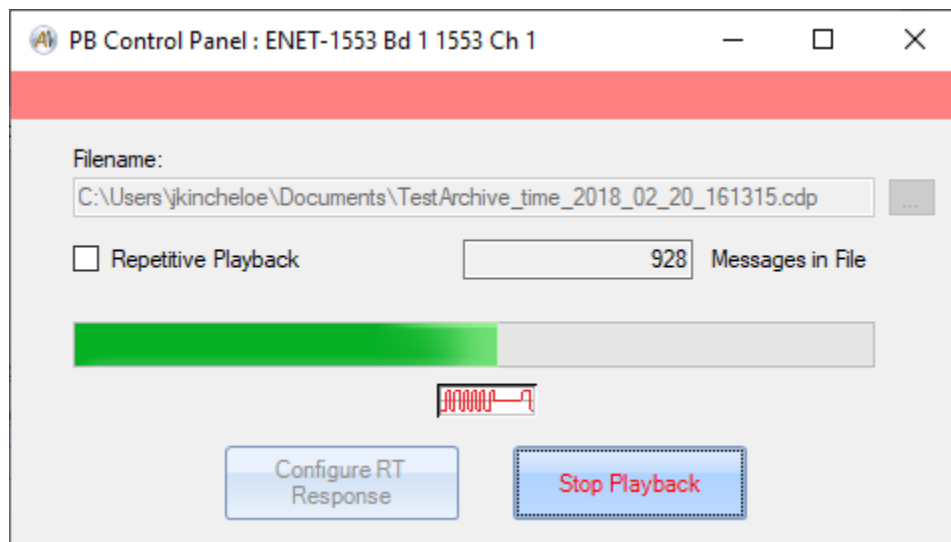

4. When all the 1553 channels are ready, go to the Board-Global Control Panel for the board that will generate the external clock signal and enable the output clock (and hit “Apply”). **This starts playback on all configured 1553 channels simultaneously and drives them all with the same clock.**

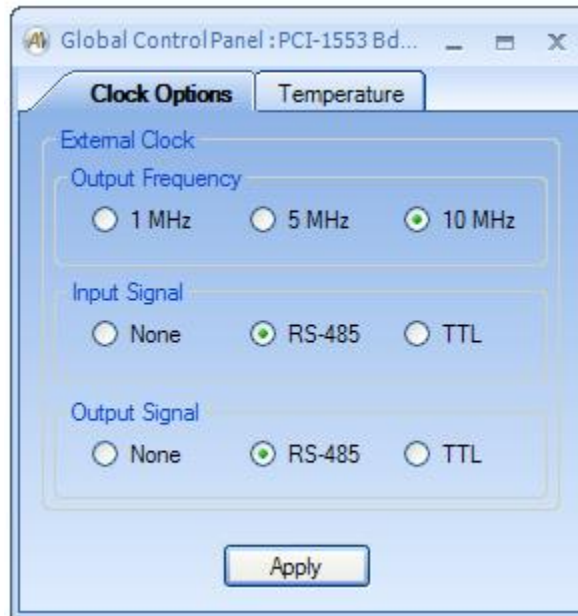

NOTE: Repetitive playback will not be synchronous after the first execution because the playback on each channel is restarted from the software level for repetitive playback, and therefore playback is not restarted on all channels simultaneously. Therefore, if you need the playback to be synchronous for multiple channels you should NOT use repetitive playback.

Chapter 4 – ARINC-429 Tools

The “A429” tab on the ribbon-bar provides tools for the ARINC-429 protocol.

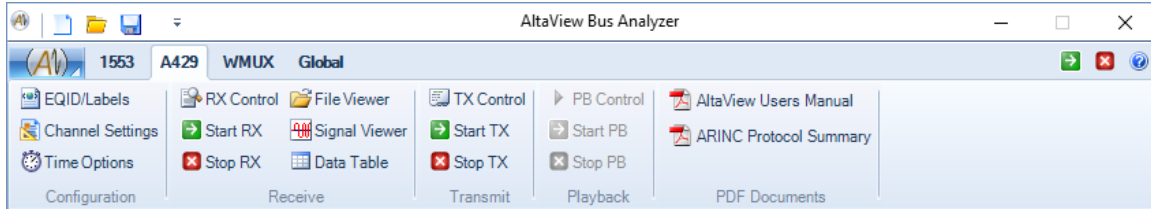

Configuration Tools

The configuration tools include the Equipment ID and Label Editor and Channel Settings.

EQID/Label Editor

The EQID/Label Editor allows the user to edit/load/save files that define equipment IDs containing sets of label definitions. These label definitions enable **AltaView** to display label data in engineering units. The equipment IDs defined here will be available in the Channel Settings tool when selecting the equipment ID to assign to a channel. **The EQID/Label Editor is disabled if the device is not enabled for full analyzer operation.**

EQID/Label definitions are stored in an XML file format. When these files are loaded they are validated against an XML schema file (AV_A429_Labels.xsd). Note that you can edit the EQID/Label definition files with any text editor if desired.

The **AltaView** configuration file will reference the specified EQID/Label definition file – it does not directly store EQID/Label definitions. Therefore you must save your EQID/Label definitions to file in order for the **AltaView** configuration file to use the definitions.

A sample set of EQID/Label definitions is provided with **AltaView** in the file **A429_Labels.xml**. Note that this is not intended to provide definitions for all possible EQID/Labels – this demonstrates most common types of labels and is provided as an example. **The user can modify this file or create a new file to define the specific EQID/Labels needed for their application.**

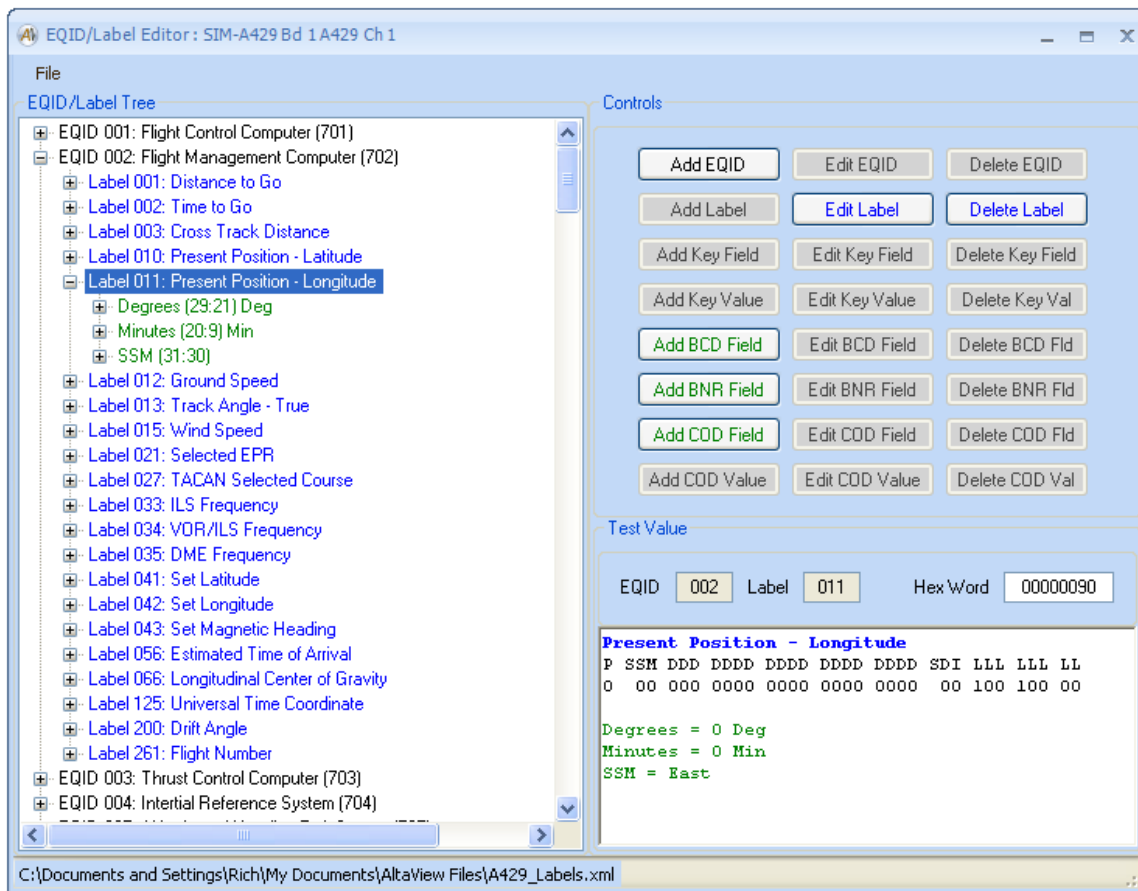

The editor shows the defined EQID and labels in a tree on the left and provides controls on the right. If a Label node is selected in the tree, the “Test Value” panel is enabled – you can enter a value in the “Hex Word” box (then click in the rich-text box below it to update the value) and this will display the interpreted label value. Controls are enabled based on the selected level in the tree.

Everything starts with an EQID node – this must be defined first. Click the “Add EQID” button to create an EQID node. Enter the desired EQID number and a name for the EQID. When you hit the “OK” button the new EQID node will be created.

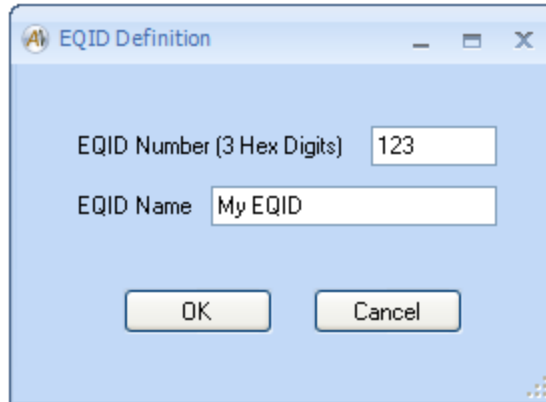

The screenshot shows a dialog box titled "EQID Definition". It contains two input fields: "EQID Number (3 Hex Digits)" with the value "123" and "EQID Name" with the value "My EQID". At the bottom, there are two buttons: "OK" and "Cancel".

If an EQID node is selected in the tree, this enables the buttons “Edit EQID”, “Delete EQID”, and “Add Label” buttons. Use the “Add Label” button to add labels to your EQID. Enter the desired Label number and name. The minimum and maximum transmit interval fields are for information only – this is not used by *AltaView* to limit label timing.

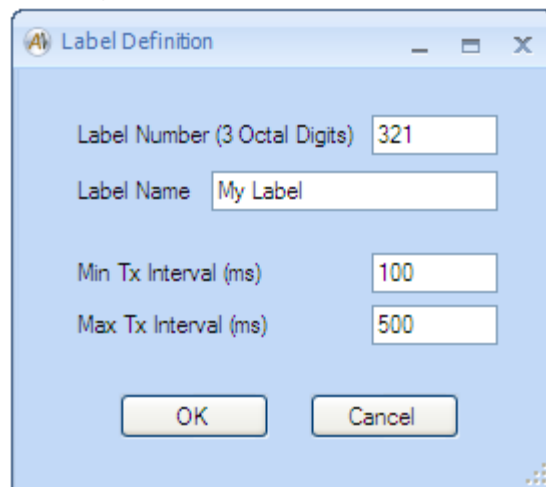

The screenshot shows a dialog box titled "Label Definition". It contains four input fields: "Label Number (3 Octal Digits)" with the value "321", "Label Name" with the value "My Label", "Min Tx Interval (ms)" with the value "100", and "Max Tx Interval (ms)" with the value "500". At the bottom, there are two buttons: "OK" and "Cancel".

If a Label node is selected in the tree, this enables the buttons “Edit Label”, “Delete Label”, and several buttons to add fields.

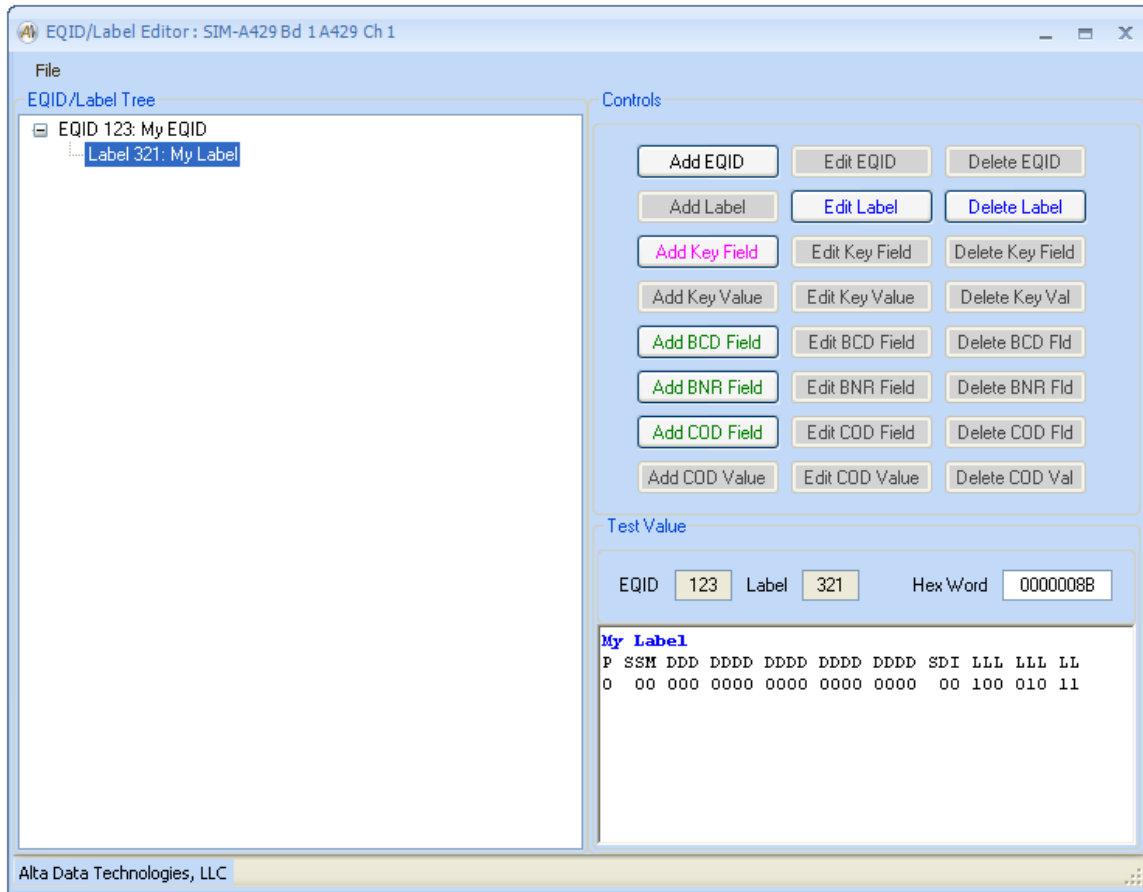

A Label node can EITHER contain a “Key Field” OR it can contain one or more standard fields (BCD, BNR, or COD fields). Most typical Labels will not need a “Key Field” and will have BCD, BNR, or COD fields under the Label node. We will discuss typical labels first. “Key Fields” will be discussed later in this section.

BCD fields are Binary Coded Decimal values with up to four bits per digit. BNR fields are binary values. COD fields are “coded bits” that can be a field of one or more bits and each possible value for the field is assigned a string to represent its meaning. COD fields are used with discrete bits and fields of bits.

NOTE ON BIT NUMBERING – ARINC-429 uses 32-bit words, where the least significant bit (LSB) is bit number 1 and the most significant bit is bit number 32. Bit 1 is transmitted first and bit 32 is transmitted last. The 8-bit label is in bits 1-8 and the parity bit is bit 32.

NOTE – AltaView supports a maximum of 16 different fields associated with a single label.

A Label can contain one or more fields. For example, Label 004 “Runway Distance to Go” contains one field (bits 29:19) with a 3-digit BCD value. This is the simplest example – the Label contains a single field.

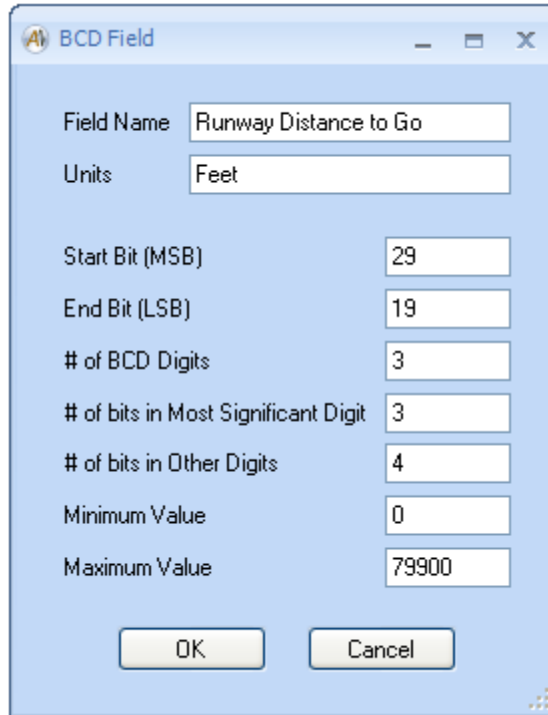

Parameter	Value
Field Name	Runway Distance to Go
Units	Feet
Start Bit (MSB)	29
End Bit (LSB)	19
# of BCD Digits	3
# of bits in Most Significant Digit	3
# of bits in Other Digits	4
Minimum Value	0
Maximum Value	79900

Note that the “Maximum Value” parameter for BCD fields tells the software where to put the decimal point. In this case, we have three BCD digits with a Maximum Value of 79900. This tells us that the least significant digit is in units of 100 Feet. If the maximum value was 79.9 then the least significant digit would be in units of 0.1 Feet.

Let's add a BNR field to our Label 321.

The screenshot shows the 'BNR Field' configuration dialog box. The 'Field Name' is 'Range to Target' and the 'Units' are 'Meters'. The 'Signed' checkbox is unchecked. The 'Start Bit (Sign)' is set to 29, the '# of Significant Bits' is 18, the 'End Bit (LSB)' is 12, and the 'Resolution (LSB value)' is 1. The 'Full Scale Range' and 'Functional Range' both have a 'Minimum Value' of 0 and a 'Maximum Value' of 262143. The 'OK' and 'Cancel' buttons are visible at the bottom.

Note that BNR values can be SIGNED or UNSIGNED. In this example we have an unsigned value (because the “Signed” checkbox is not checked). For unsigned values, the “Start Bit (Sign)” bit is included in the number of significant bits, so in this case bit 29 is a significant bit rather than a sign bit. We have specified 18 significant bits, so our end bit is bit 12 ($29 - 18 + 1$).

If we check the “Signed” checkbox, now we have a signed value and bit 29 becomes the sign bit and is no longer a significant bit. If we still have 18 significant bits, this changes our end bit to 11 ($29-18$), so now we have 18 significant bits in the value in addition to the sign bit.

Note that the fields for “End Bit (LSB)” and “Full Scale Range” (minimum and maximum) are automatically updated as you change these settings. The “Functional Range” will default to match the “Full Scale Range”, but you can edit these as desired (must be within the “Full Scale Range”).

Some Labels contain multiple fields. For example, Label 011 “Present Position – Longitude” contains three fields – Degrees, Minutes, and the SSM (Sign-Status Matrix) tells us if this is East or West longitude.

The Degrees field is defined as shown here.

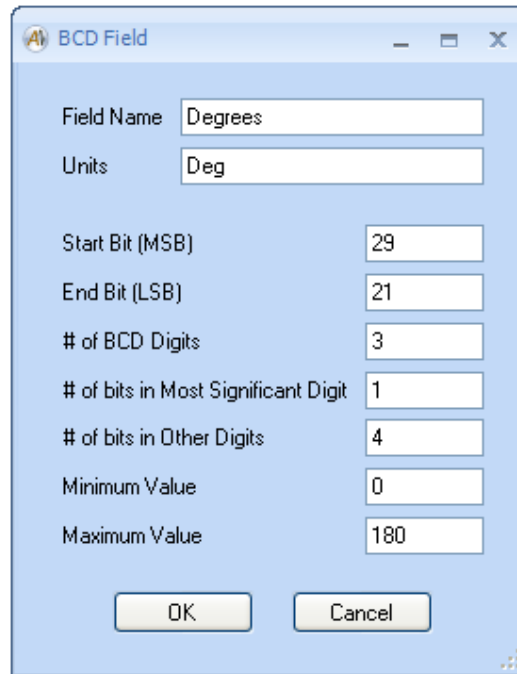

The screenshot shows a dialog box titled "BCD Field" with the following fields and values:

Field Name	Degrees
Units	Deg
Start Bit (MSB)	29
End Bit (LSB)	21
# of BCD Digits	3
# of bits in Most Significant Digit	1
# of bits in Other Digits	4
Minimum Value	0
Maximum Value	180

Buttons: OK, Cancel

The Minutes field is defined as shown here.

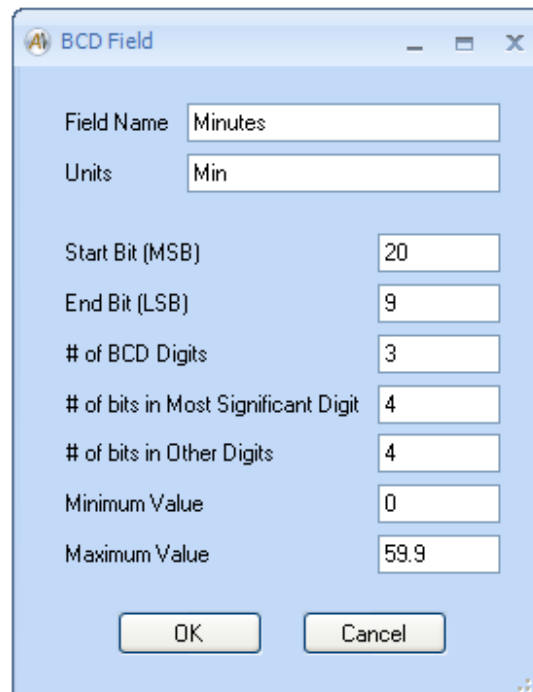

The screenshot shows a dialog box titled "BCD Field" with the following fields and values:

Field Name	Minutes
Units	Min
Start Bit (MSB)	20
End Bit (LSB)	9
# of BCD Digits	3
# of bits in Most Significant Digit	4
# of bits in Other Digits	4
Minimum Value	0
Maximum Value	59.9

Buttons: OK, Cancel

The SSM field is a COD (coded bits) field. This is a two-bit field (bits 31:30) with four possible values (00 = East, 01 = No Computed Data, 10 = Functional Test, and 11 = West). We first define the COD field to specify the field name and bits (and optionally units, which are not used in this case).

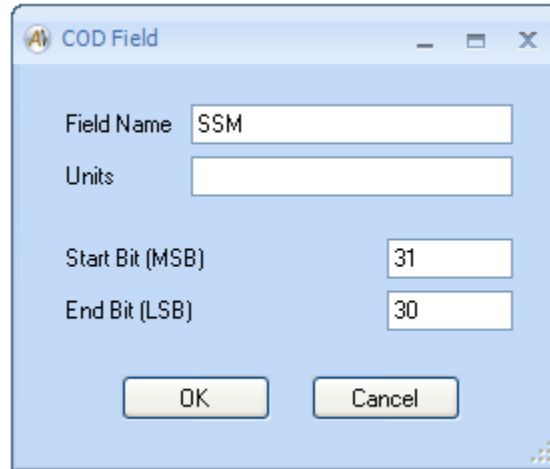

The screenshot shows a dialog box titled "COD Field". It contains the following fields and values:

- Field Name: SSM
- Units: (empty)
- Start Bit (MSB): 31
- End Bit (LSB): 30

At the bottom of the dialog are two buttons: "OK" and "Cancel".

Now we need to define each of the possible COD field values using the "Add COD Value" button.

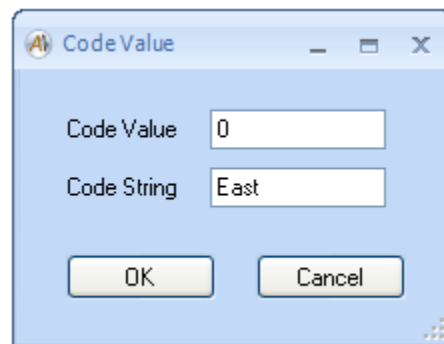

The screenshot shows a dialog box titled "Code Value". It contains the following fields and values:

- Code Value: 0
- Code String: East

At the bottom of the dialog are two buttons: "OK" and "Cancel".

Now we have three labels in our EQID. These labels use BCD fields, BNR fields, and COD fields.

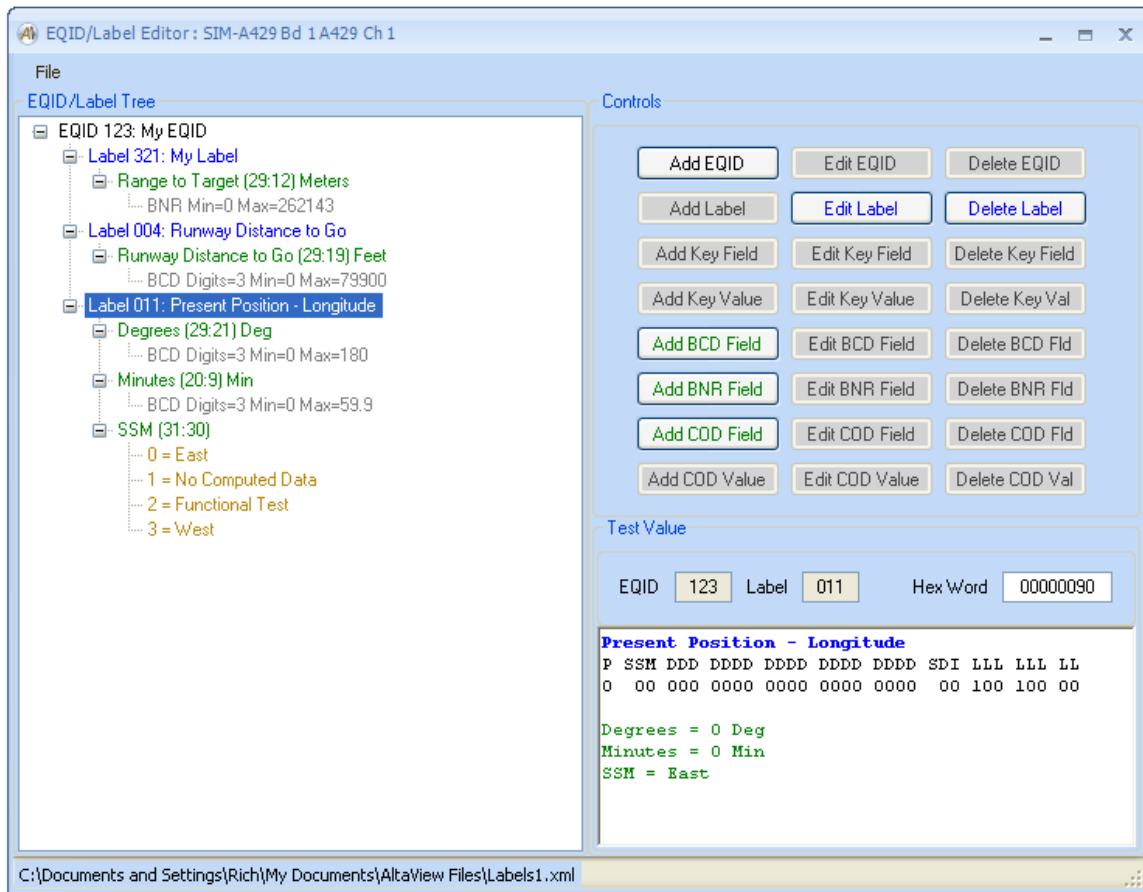

The “Key Field” is used when one field of bits in the Label determine how the rest of the word should be interpreted. For example, Label 037 “HF COM Frequency” uses bit 9 as the “Word Identifier”.

If bit 9 is 0, then there are four fields:

- Bit 9 is “Word Ident”
- Bit 10 is “SSM/AM Mode”
- Bit 11 is “USB/LSB Mode”
- Bits 29:12 are “Frequency (MHz)”

If bit 9 is 1, then there is one field:

- Bit 9 is “Word Ident”
- Bits 29:26 are “Frequency (KHz)”

We will create Label 037 and define a “Key Field” using bit 9. Each “Key Value” (0 or 1) can then contain the appropriate field definitions (BCD, BNR, or COD fields).

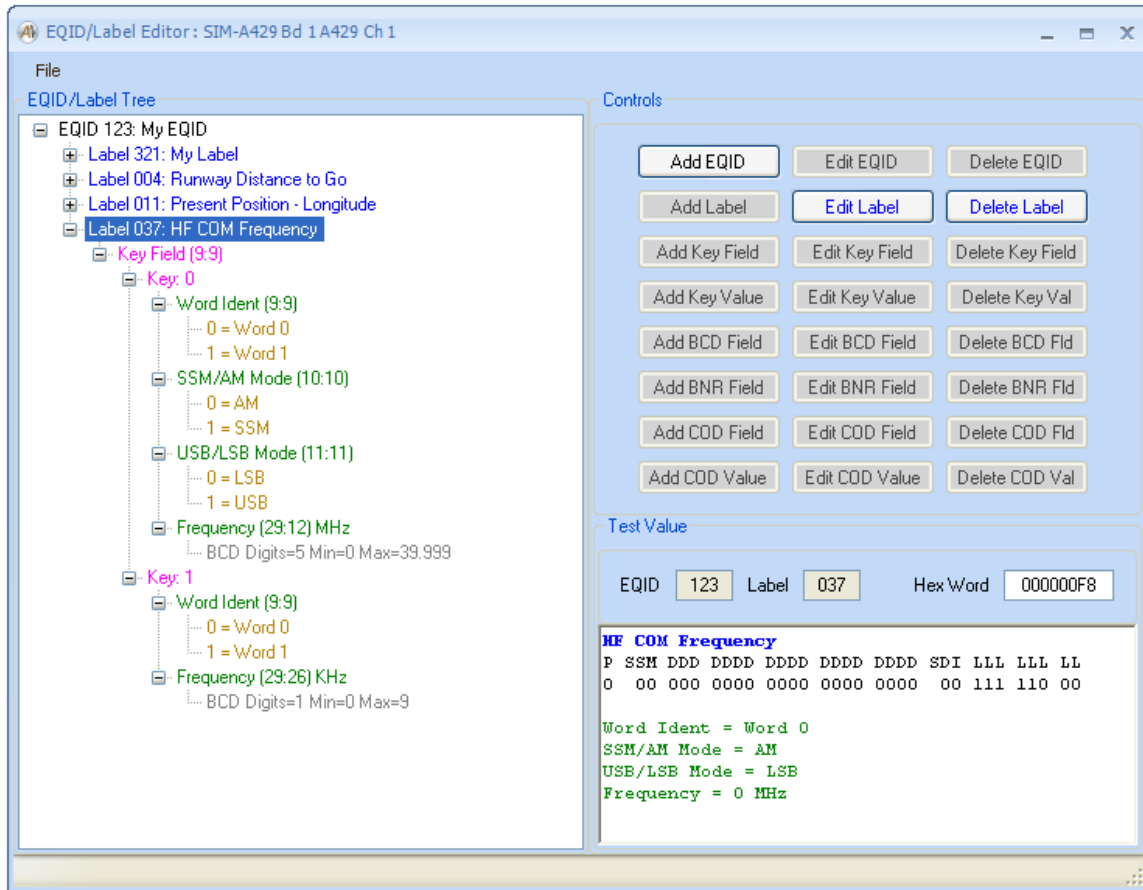

Channel Settings

The Channel Settings tool allows the user to specify the baud rate and assign an Equipment ID for each channel.

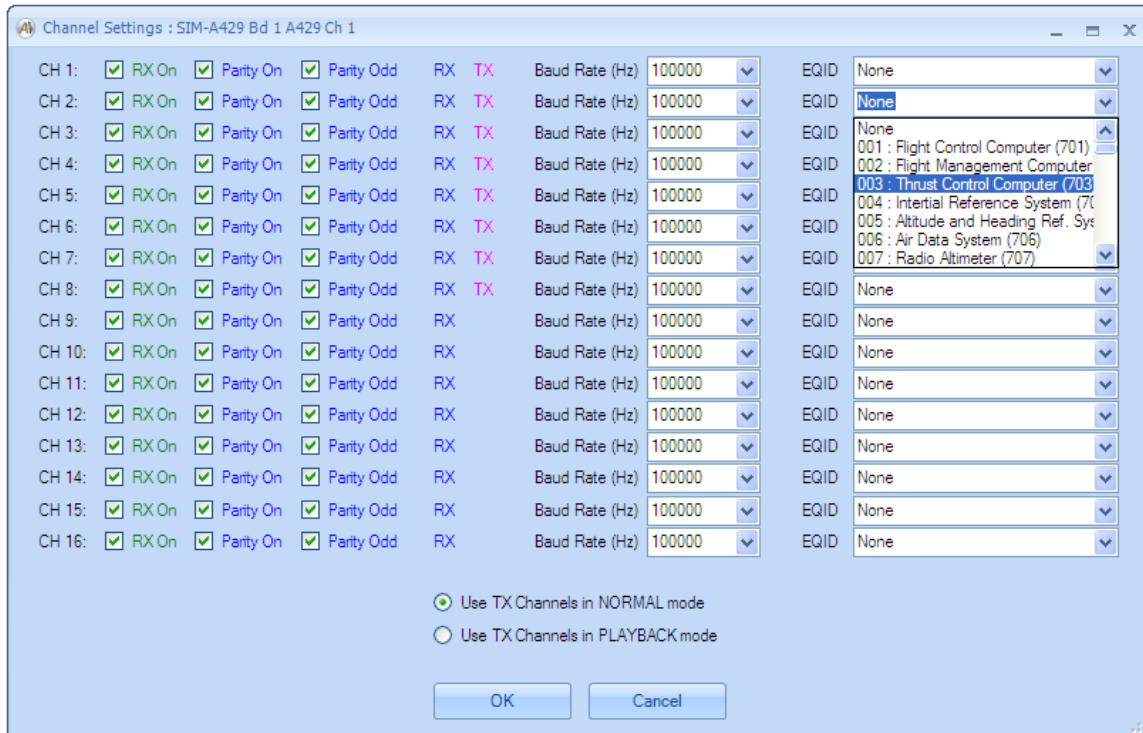

Check-boxes are provided to select channels to include in the multi-channel receive buffer (RX On). These check-boxes should always be checked if you want **AltaView** to be able to see the channels. If it is not checked then the **AltaView** RX Tools will not see any labels received on the channel. Check-boxes are also provided to configure the parity-checking for receive channels. Odd parity is used by default. If you uncheck “Parity On” then parity is not checked. If “Parity On” is checked but “Parity Odd” is unchecked, then the receive channel will expect even parity. Note that parity generation for transmit channels is controlled at the label level in the TX Control Panel – when you define or edit transmit labels you will have options to control parity.

The Baud Rate (in Hz) can be set to any value from 500 to 500000. The combo-boxes for bit rate provide three standard options – 100000 Hz (A429 high speed), 50000 Hz (used in Chinese and Russian systems), or 12500 Hz (A429 low speed).

The combo-boxes for EQID will be populated with any EQID defined in the EQID/Label Editor for the A429 device.

Receive Tools

The A429 Receive Tools use the multi-channel receive buffer (MCRX) to monitor labels on all receive channels for the A429 device.

RX Control

The “RX Control” button will bring up the RX Control Panel for the selected A429 Device. ***If the device is not enabled for full analyzer operation, the Snapshot Viewer, message archiving, and trigger features are disabled.***

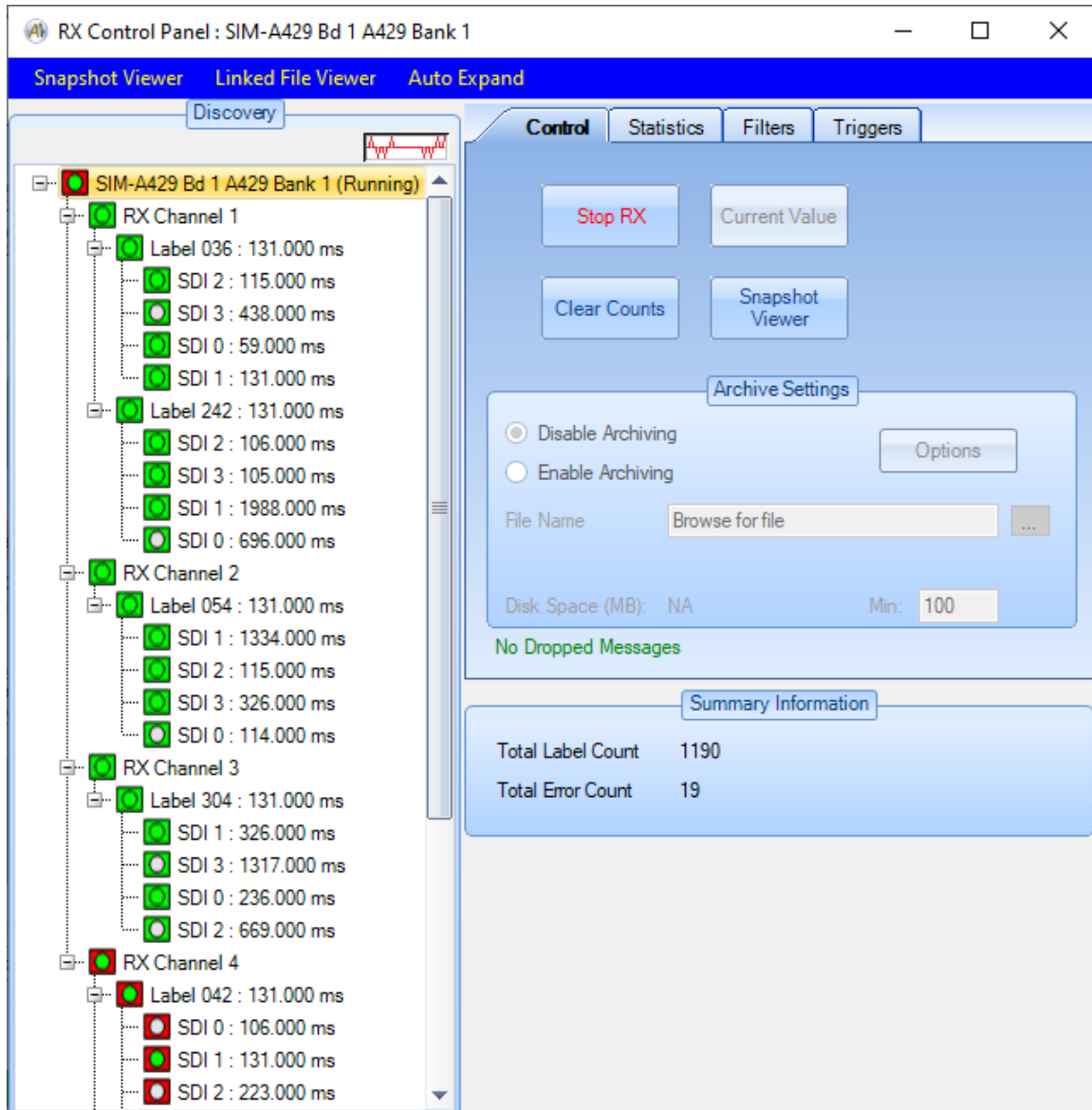

The RX Control Panel consists of the “Discovery” tree on the left and controls on the right. Summary information including Label count and Error count is provided on the lower right.

The discovery tree will populate itself as labels are detected on the RX channels. The root of the tree is the A429 device and bus activity is represented by RX channel, label, and SDI. Each node in the tree has an “activity icon”, which is a square with a circle inside of it. The square represents past conditions and the circle represents the current condition. There are three colors representing possible conditions:

Gray = No Activity

Green = Activity with no errors

Red = Activity with protocol errors (parity, decode error, etc.)

For example, if the activity icon is Red in the square and Green in the circle, this indicates that there was an error sometime in the past but most recent activity had no errors.

Label and SDI nodes display label period in milliseconds, based on the time period since the last occurrence of the label.

RX Linked File Viewer

You can open a **RX Linked File Viewer** by clicking the “Linked File Viewer” menu-strip item. This opens an instance of the RX File Viewer that is “linked” to this A429 device. The linked file viewer will use the EQID/Label definitions as assigned to the channels of this A429 device to display labels with engineering units.

If the RX is NOT RUNNING for the device, then as you move through a file in the Linked File Viewer the labels are fed into the RX to drive the displays. Therefore you can single-step through labels in the viewer and the discovery tree will populate, the statistics counters will increment, the current value viewers will update, and the Data Table will update. Note that you can move forward or backward in the file and every time you move in the file viewer the current label (first label in the file viewer display) is fed into the RX, therefore if you move back and forth you can count the same message multiple times so the statistics counts could be thrown off by this.

If the RX for the device IS RUNNING, then the Linked File Viewer does NOT feed labels into the RX to drive the displays – the live RX drives the displays in this case.

RX Discovery Tree

The discovery tree can be reorganized by the user. You can right-click on any node and select the options to “Move Up”, “Move Down”, or “Expand All”. The “Expand All” selection will expand all nodes below the node you right-clicked on.

At the Label and SDI levels, you can also select “View Current Value” to see the most recent occurrence of that label. This is identical to clicking the “Current Value” button in the “Control” tab.

Control Tab

The RX controls consist of tabs for Control, Statistics, Filters, and Triggers. The “Control” tab is shown here:

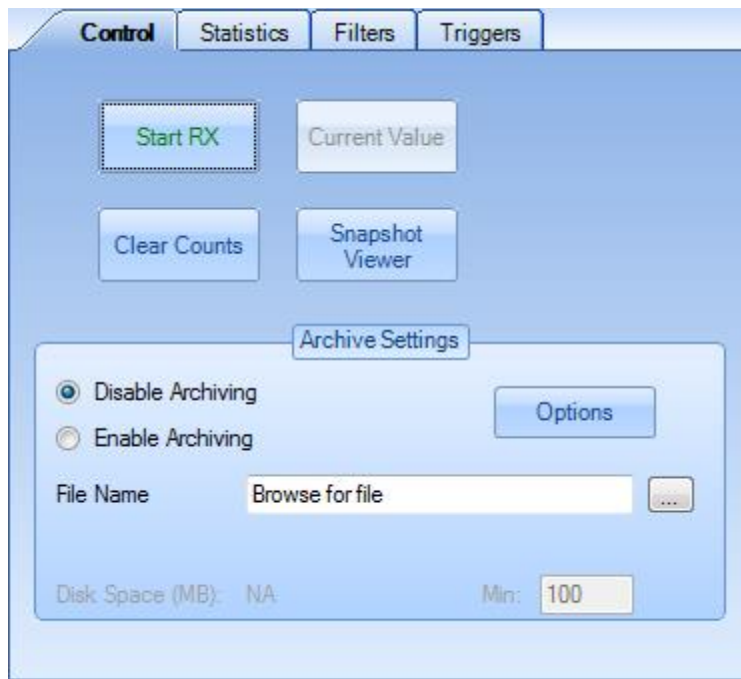

The “Start RX” button starts the RX channels. When the RX channels are running, this changes to a “Stop RX” button.

When the RX channels are not running the “Archive Settings” panel is enabled. You can enable or disable archiving to record messages to a data file, and of course you can specify the file name to store the messages to. If archiving is enabled and a valid file/path has been selected, the available disk space (in MB) is displayed. You can specify the minimum free disk space to preserve – if

AltaView detects that the free disk space has dropped below the minimum value it will stop the RX channels. The minimum free disk space defaults to 100 MB.

The “Options” button provides a dialog box where you can specify the desired archiving options.

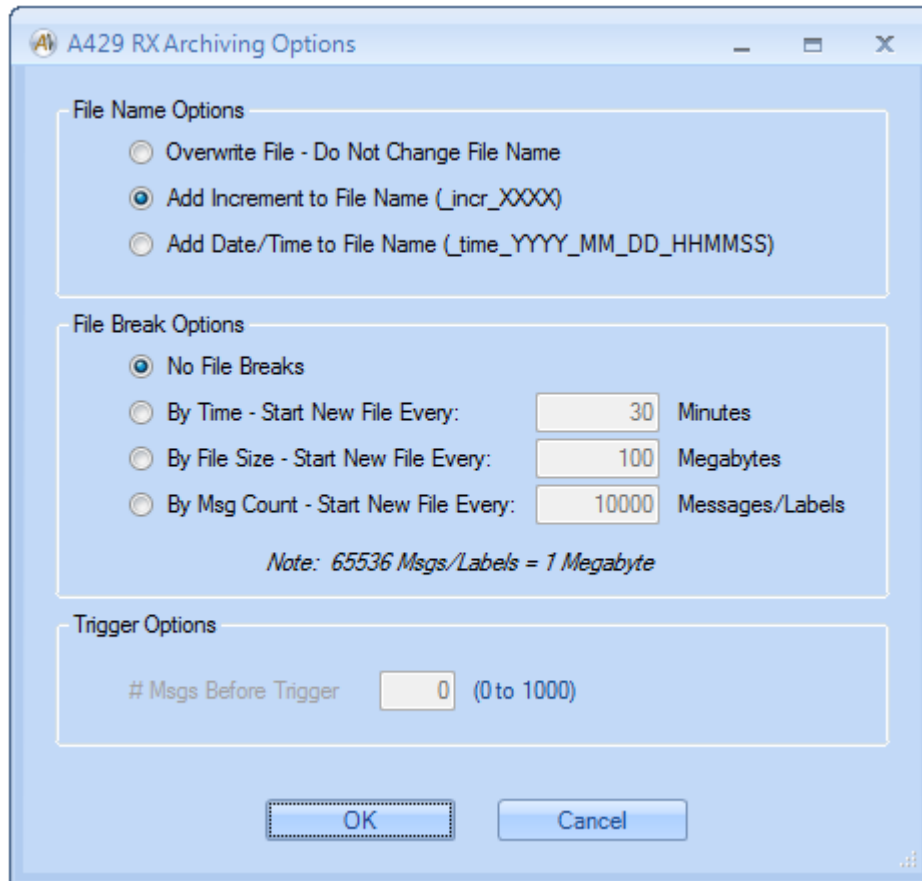

Under File Name Options, the option to “Add Increment to File Name” is selected by default – this prevents you from accidentally overwriting an existing file. If you do want to overwrite the file if it exists, you can use the “Overwrite File” option. You also have the option to add a date/time to the file name rather than an incrementing number.

The File Break Options allow you to specify the condition to close one archive file and open a new one. Note that you cannot do this if “Overwrite File” is selected. You can start a new file based on time in minutes, file size in megabytes, or number of messages.

If a trigger is enabled (in the “Triggers” tab) you will have the option to record up to 1000 messages before the trigger message. For example, if you are triggering

on an error you can use this to capture the labels leading up to the label where the error occurred.

If you enable archiving and start the RX channels, you will see an archiving indicator at the top of the Discovery panel (left of the “running” indicator) as shown here:

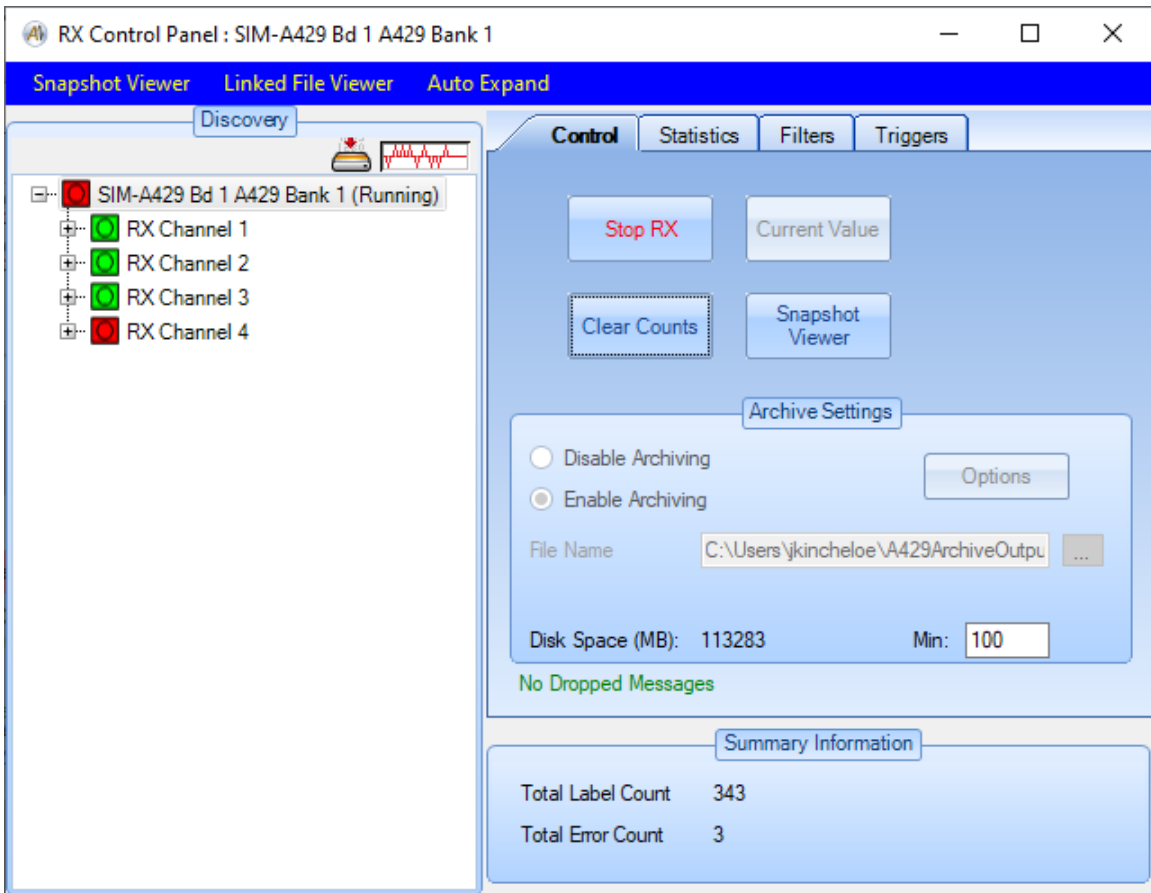

If you have enabled a RX Trigger, then the archiving indicator will not appear until the trigger event occurs and the RX channels start recording messages to file. Note that RX triggers only apply for archiving to file – the trigger does not affect the discovery tree, snapshot viewer, etc.

The “Clear Counts” button zeroes the label and error counters and clears the discovery tree. This can be useful if you want to clear any past conditions. The RX state is automatically cleared when the RX channels are started so old message counts etc. will not carry over to a new run of the RX channels.

RX Current Value Viewer

If a label level node is selected in the discovery tree, then the “Current Value” button will be enabled. Either the “Current Value” button or the right-click option “View Current Value” will display the current value view for the selected label.

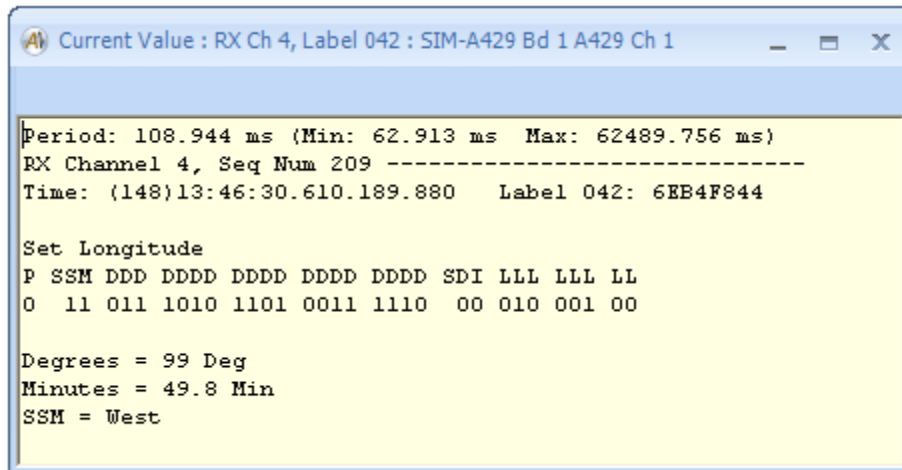

```
Current Value : RX Ch 4, Label 042 : SIM-A429 Bd 1 A429 Ch 1
-----
Period: 108.944 ms (Min: 62.913 ms Max: 62489.756 ms)
RX Channel 4, Seq Num 209 -----
Time: (148)13:46:30.610.189.880 Label 042: 6EB4F844

Set Longitude
P SSM DDD DDDD DDDD DDDD SDI LLL LLL LL
0 11 011 1010 1101 0011 1110 00 010 001 00

Degrees = 99 Deg
Minutes = 49.8 Min
SSM = West
```

Note that the Current Value display shows period information as well as the most recent value for the label or SDI. The first line shows the current period (the period between the last two messages for this label), the minimum period, and the maximum period. This can be very useful for verifying that messages occur at the rates they are supposed to as defined for the system.

RX Snapshot Viewer

The “Snapshot Viewer” button allows you to examine a snapshot of up to 1000 messages from MCRX memory. The RX Snapshot Viewer is shown below:

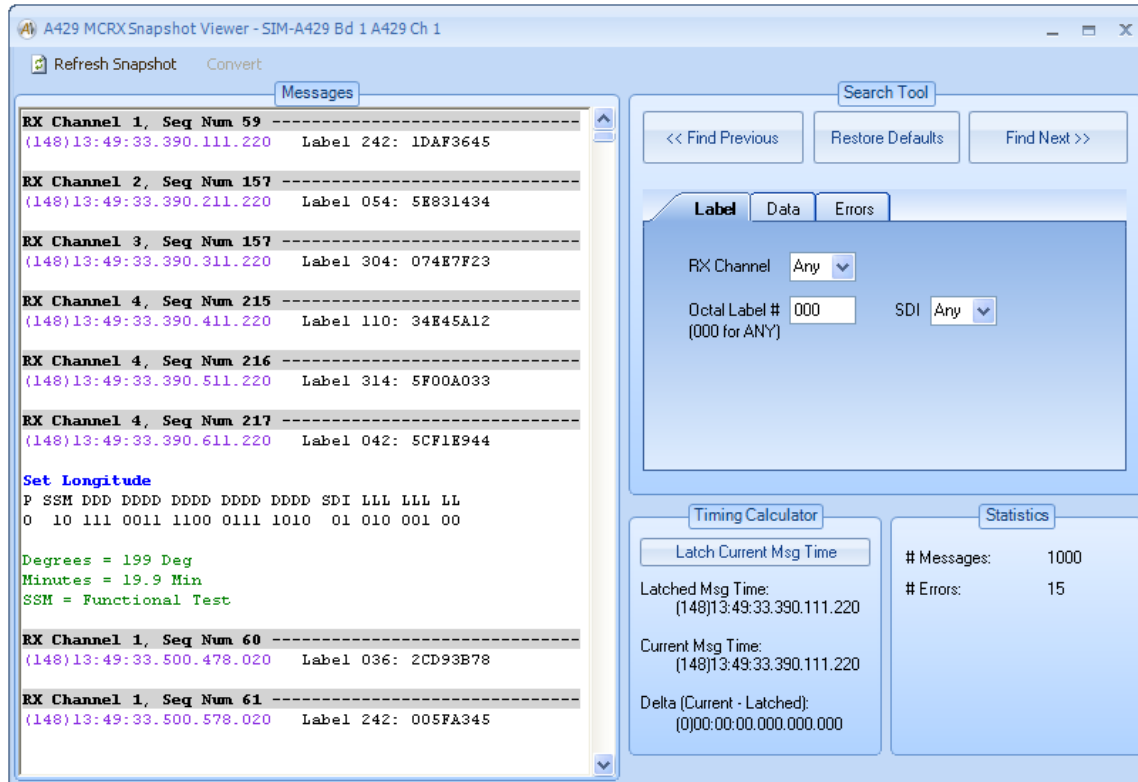

A menu-strip provides the following options:

“Refresh Snapshot” – Will update the display with the current messages in BM memory (up to 1000 messages). The messages are displayed on the left in a scrollable window.

“Convert” – Provides a pull-down menu with file conversion options. *The conversion options are not yet implemented.*

The message display shows the time-stamp in magenta and the raw hex word in black. Any errors are shown in red. If the label has been defined in the EQID assigned to the channel, the engineering units for the label are also displayed.

On the right side of the Snapshot Viewer you have a Search Tool, a Timing Calculator, and a Statistics panel.

The Statistics panel provides basic counts for the current set of labels in the snapshot – number of labels and number of errors.

The Timing Calculator is used to measure the time difference from one message to another. The first (top) message displayed in the “Messages” panel is the current message – you will see that the Timing Calculator always displays the “Current Msg Time” as the timestamp of the first message in the “Messages” panel. If you click on the button to “Latch Current Msg Time” the Timing Calculator will save the timestamp of the current message as the “Latched Msg Time”. Now as you move through the messages the “Current Msg Time” will change and the Timing Calculator will update the “Delta (Current – Latched)” time. As the name indicates, this delta time is the result from subtracting the latched time from the current time. Negative delta times are shown in red.

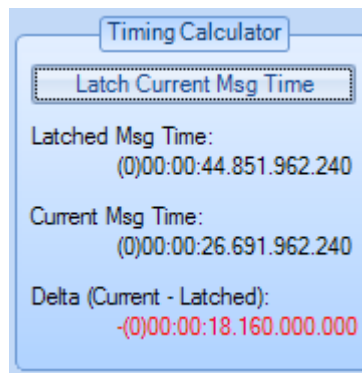

Note that the “Latched” message is shown with a dark yellow background for the channel and sequence number line in the message display.

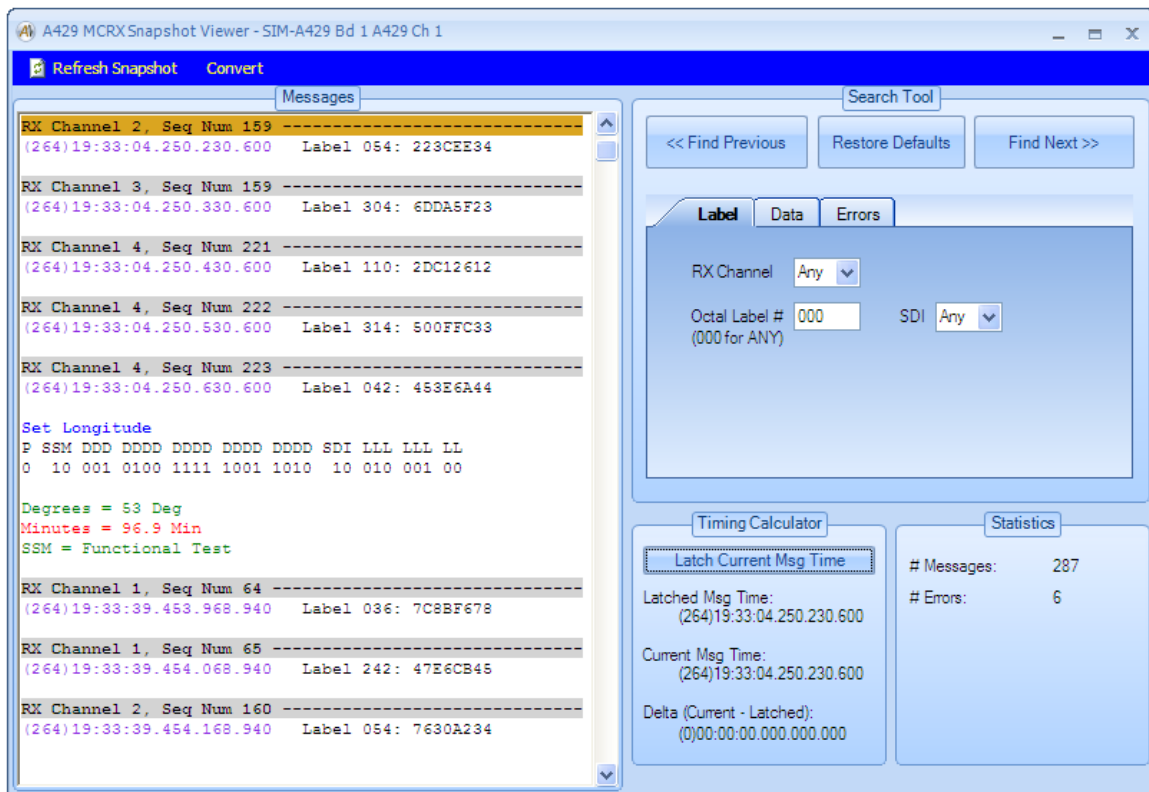

The Search Tool is a very powerful utility to find specific messages and conditions. This tool lets you specify search criterion in RX channel, label/SDI, data, errors, and/or a combination of them. You can search forward or backward from the current message.

Note that the last message found by the search tool is shown with a light blue background for the channel and sequence number line in the message display.

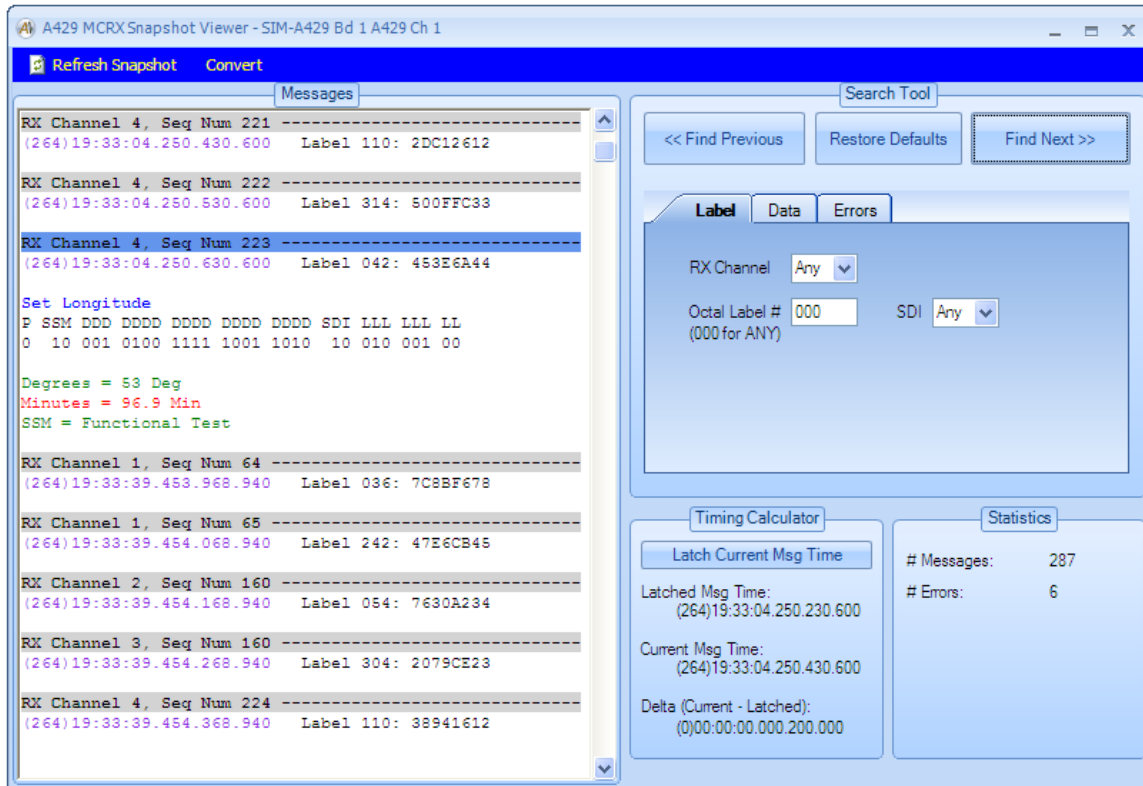

Statistics Tab

The “Statistics” tab provides detailed counters for labels and errors, etc. as shown below:

The screenshot shows the RX Control Panel interface for SIM-A429 Bd 1 A429 Bank 1. The interface includes a top navigation bar with 'Snapshot Viewer', 'Linked File Viewer', and 'Auto Expand'. Below this is a 'Discovery' tab with a tree view on the left and a 'Statistics' tab on the right. The tree view shows a hierarchy starting with 'SIM-A429 Bd 1 A429 Bank 1 (Running)', which contains four 'RX Channel' nodes. 'RX Channel 4' is selected and highlighted in yellow. Under 'RX Channel 4', there are four 'Label' nodes: 'Label 042', 'Label 110', and 'Label 314', all with a duration of 128.000 ms. The 'Statistics' tab has sub-tabs for 'Control', 'Statistics', 'Filters', and 'Triggers'. The 'Statistics' sub-tab is active and shows two panels. The top panel, titled 'Top Level', displays 'Labels: 4081' and 'Errors: 60' with a 'Clear Counts' button. The bottom panel, titled 'RX Channel 4, Label 042', displays 'Labels: 583' and 'Errors: 60'. At the bottom of the statistics area is a 'Summary Information' panel showing 'Total Label Count: 4081' and 'Total Error Count: 60'.

The upper panel provides a top-level count of labels and errors. A “Clear Counts” button is provided here as well – this is identical to the “Clear Counts” button on the “Control” tab.

The lower panel is dependent upon the node selected in the discovery tree. In this case, we have selected the node for RX Channel 4, Label 042 (by left-clicking on the node). The lower panel shows the label and error counts for the selected level. If the channel-level node for the channel is selected then the count information will apply to the entire channel. If the top-level node is selected then the count information will apply to the entire device (all channels).

Filters Tab

The “Filters” tab allows you to define which messages to capture by RX Channel, Label, and SDI. Note that you will see a short delay the first time you select the “Filters” tab for the device. This is because the software populates the filter tree the first time it is opened – it takes a few seconds to populate this tree (up to 16 channels with 256 labels per channel and 4 SDI values per label).

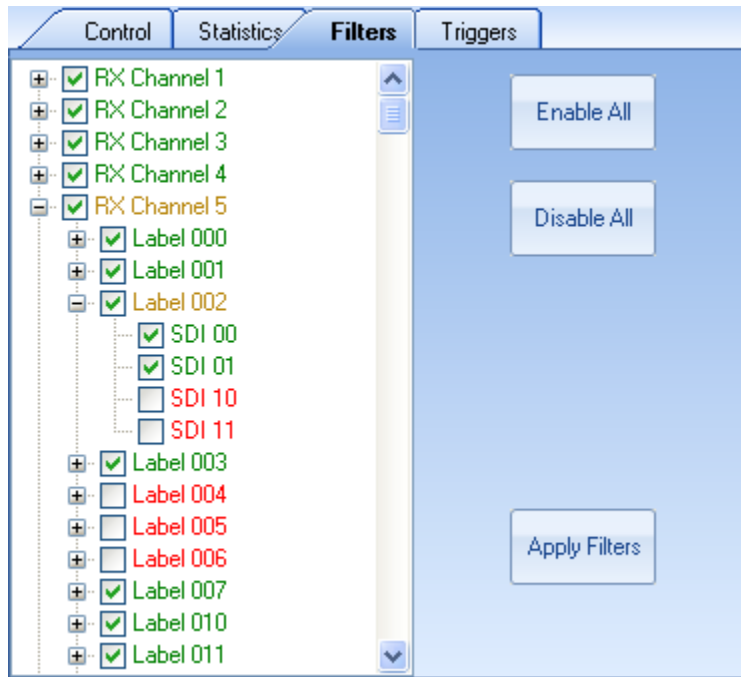

The “Enable All” button will enable the MCRX to capture all messages on all RX channels. The “Disable All” button will block all messages. The “Apply Filters” button will apply the selected filter settings. No changes take effect until the “Apply Filters” button is clicked.

Triggers Tab

The “Triggers” tab allows you to define a trigger event that will start RX archiving to file. The trigger is not used by the RX Snapshot Viewer, Discovery Tree, etc.

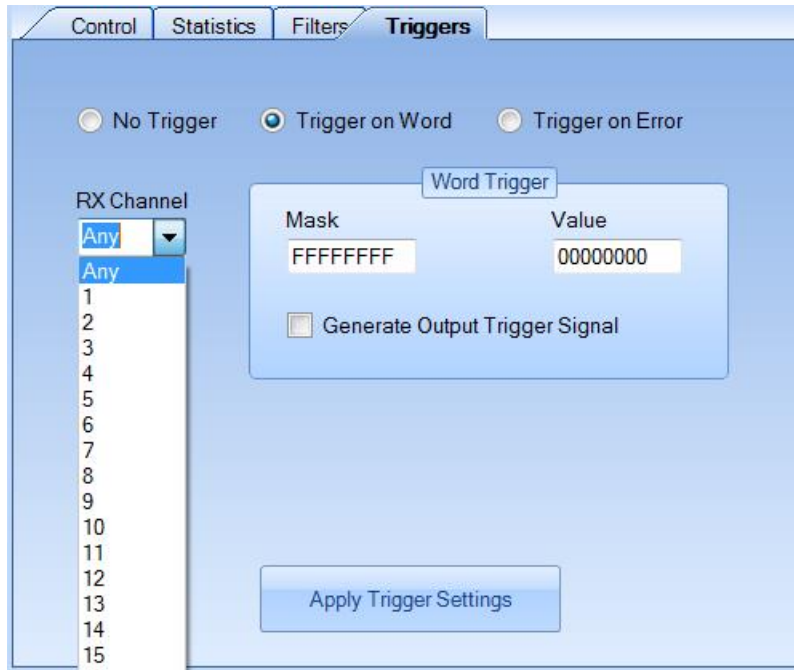

There are three basic trigger options:

1. No Trigger
2. Trigger on Word
3. Trigger on Error

If “No Trigger” is selected then the MCRX will always trigger itself on the first message it sees.

If “Trigger on Word” is selected you will need to select the RX Channel (or ANY) and specify a Mask and a Value. The word from the A429 message/label is first ANDed with the Mask then the result is compared to the Value. If the two are equal then the trigger is asserted. If the checkbox “Generate Output Trigger Signal” is checked, then the TRG OUT signal will be asserted every time a label matches the mask/value comparison.

If “Trigger on Error” is selected then any time an error condition is detected in a message the trigger will be asserted.

Obviously, you can only start RX archive to file from the trigger if you have enabled archiving in the “Control” tab.

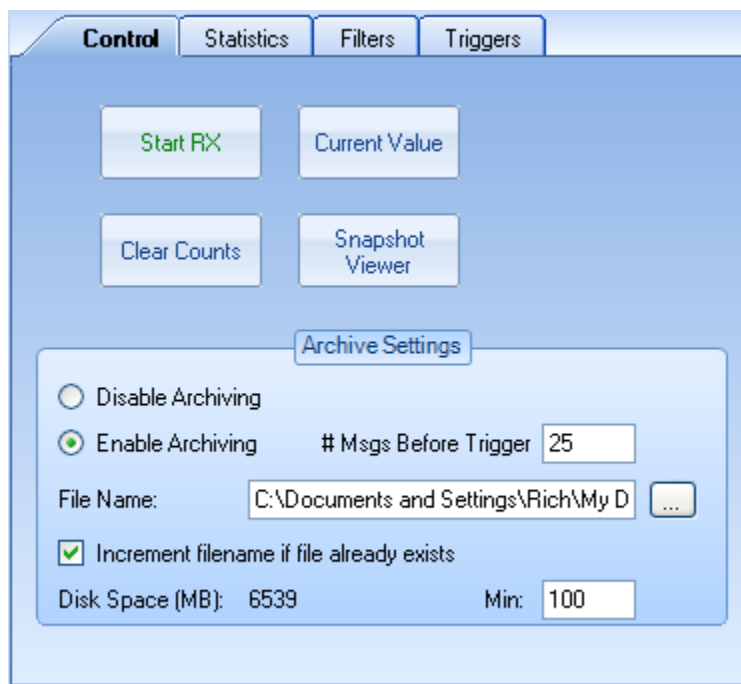

If you have enabled a trigger, you will be able to set the “# Msgs Before Trigger”. This allows you to specify the number of messages preceding the trigger message to be stored in the archive file. If this value is zero then the first message in the file will be the trigger message.

NOTE – You MUST click the “Apply Trigger Settings” button for any of your settings to be used! You MUST start the RX channels before the software will archive to file.

Start RX

The “Start RX” button will start the RX Channels for the selected A429 device. This button does not activate any other forms or windows.

Stop RX

The “Stop RX” button will stop the RX Channels for the selected A429 device. This button does not activate any other forms or windows.

File Viewer

The “File Viewer” button will bring up the A429 RX File Viewer window (unlinked File Viewer). Note that this control is not associated with a specific device and may be used even if no devices are open under *AltaView*.

If you want a “Linked File Viewer”, which is associated with a specific A429 device, then use the “Linked File Viewer” menu-strip option in the A429 RX Control Panel for that device.

The File Viewer is very similar to the Snapshot Viewer, but it operates on a saved file rather than on a memory snapshot.

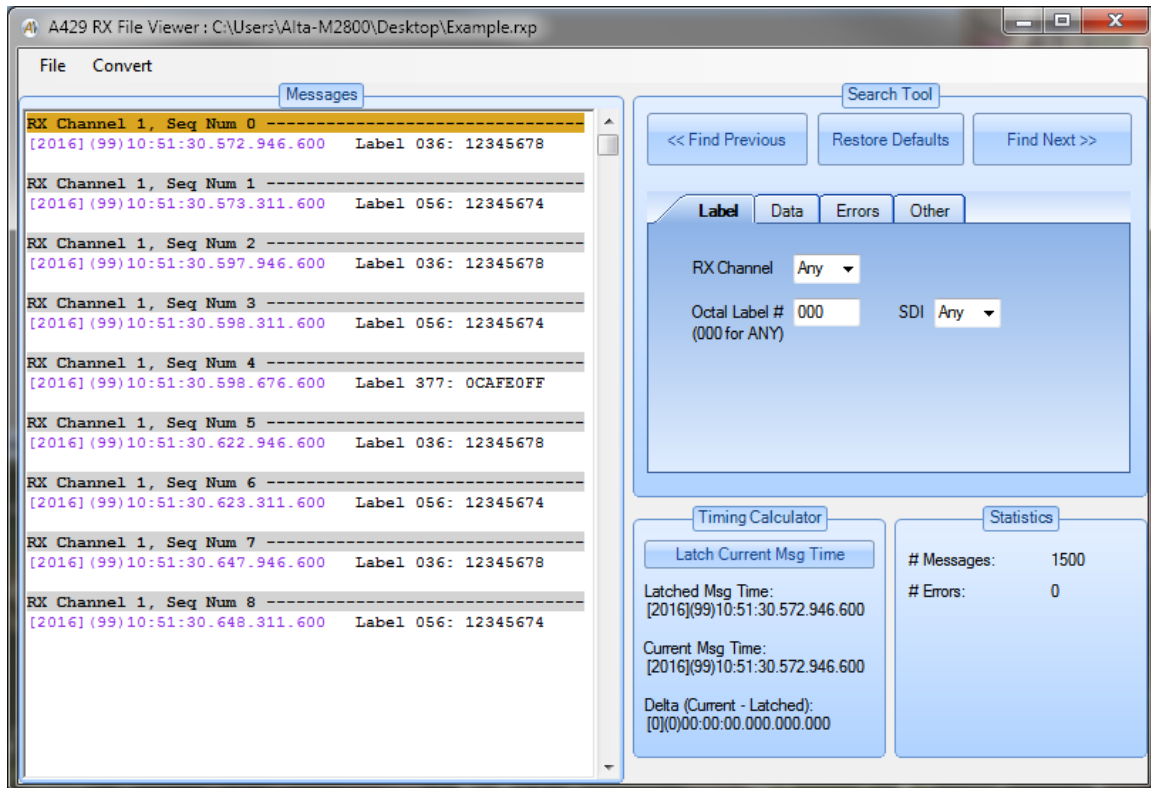

Note that the menu-strip provides a “File” option rather than the “Refresh Snapshot” option found in the Snapshot Viewer. Use the “File” menu to load a saved A429 Rx monitor file.

The Search Tool, Timing Calculator, and Statistics panel have all of the functionality found in the Snapshot Viewer.

Find Timestamp

The A429 RX File Viewer provides an additional function not available in the Snapshot Viewer – the Find Timestamp search located in the ‘Other’ tab.

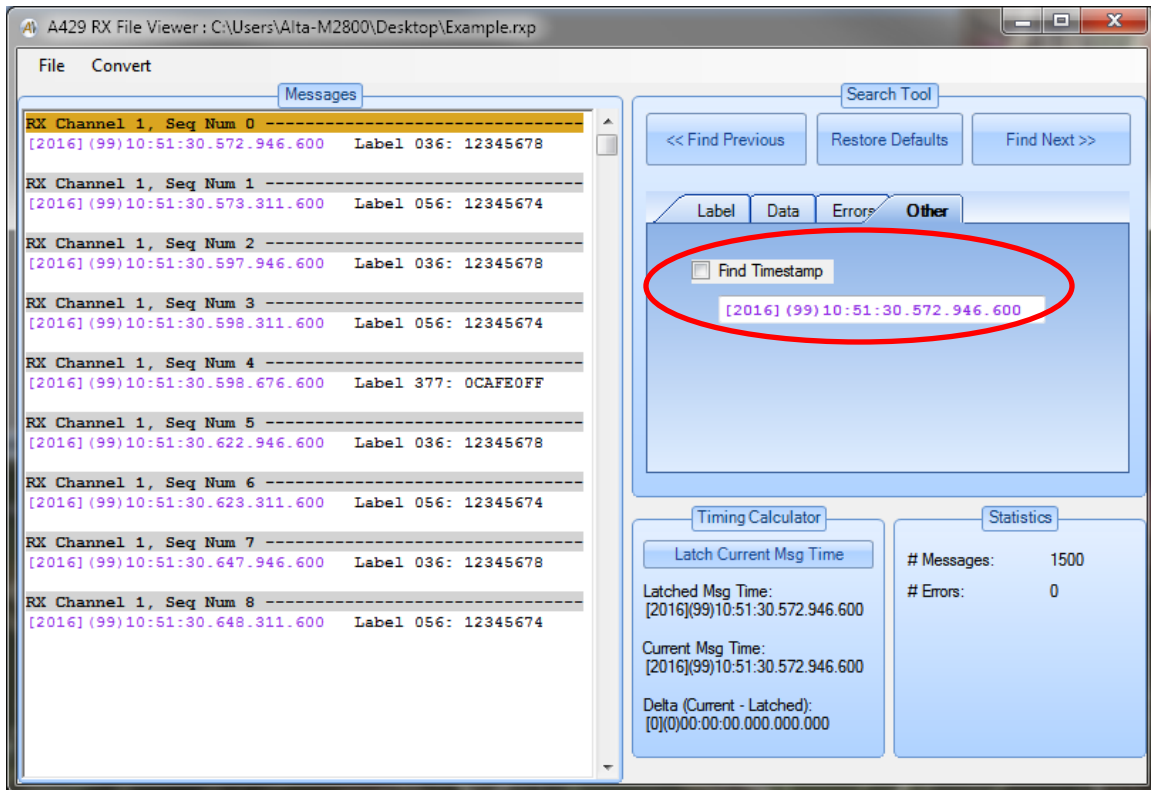

The Find Timestamp value is updated with the timestamp value of the first message displayed in the ‘Messages’ list. To search for a specified timestamp:

1. Check the Find Timestamp checkbox,
2. Enter a timestamp value to search for,
3. Click either the ‘Find Previous’ or ‘Find Next’ button.

* Note that the timestamp value to search for does not need to be specified to the full 20 nanosecond precision of a timestamp:

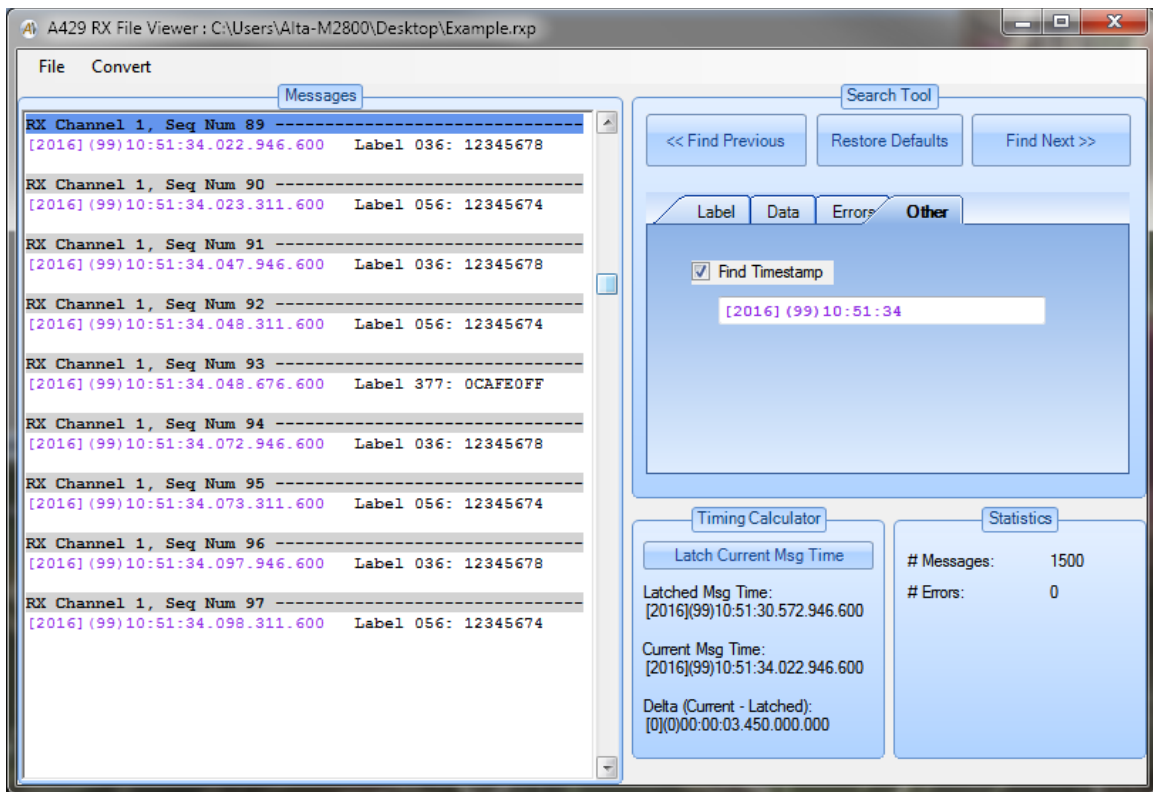

Signal Viewer

The Signal Viewer uses an A/D (analog to digital) converter to display the electrical signal on the selected A429 receive channel (1 or 2). Note that not all Alta A429 boards/devices include the A/D converter needed for the Signal Viewer – the “Signal Viewer” button is only enabled if it is present on the selected A429 device. ***If the device is not enabled for full analyzer operation the Signal Viewer feature is disabled.***

NOTE: Windows 7 “Aero” themes (with “glass effects” and other gee whiz graphics features) can cause the Signal Viewer to flicker a lot as the display updates while the viewer is running. This is not a problem but can be annoying. You can fix this by closing **AltaView**, change to a “Basic” theme, and then run **AltaView** again – now when you run the Signal Viewer you should no longer see the flicker.

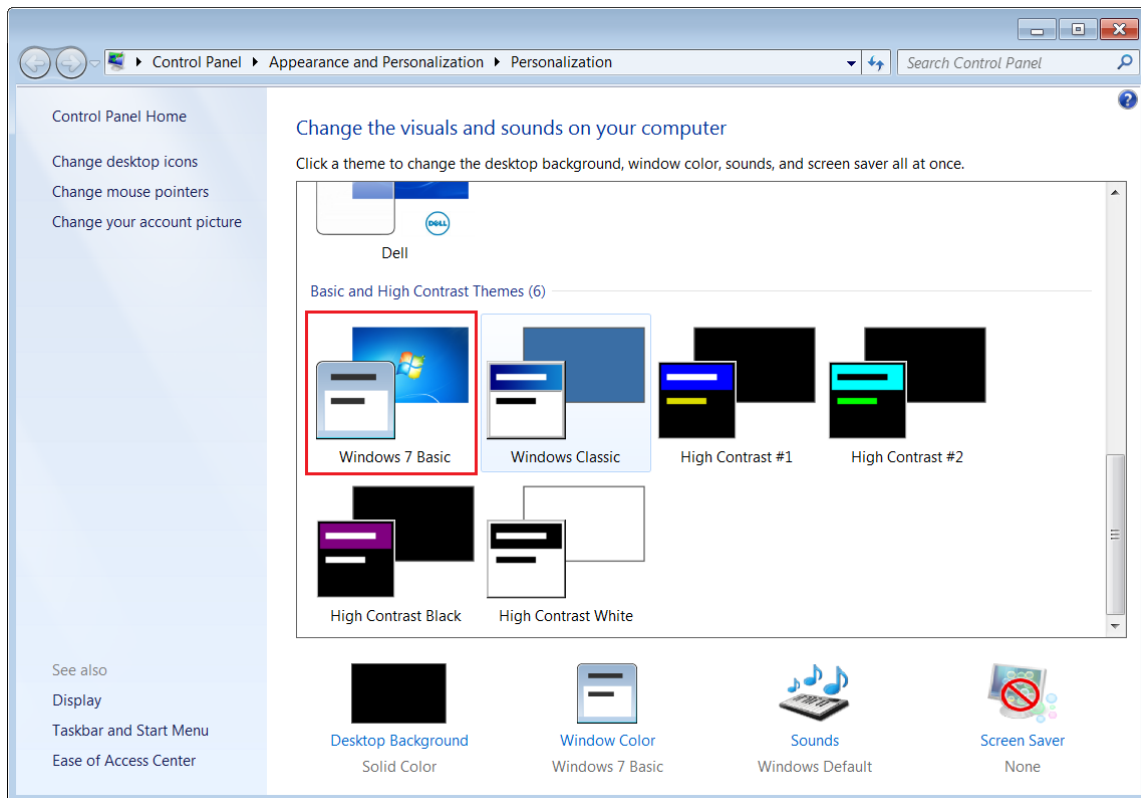

The “Signal Viewer” button will bring up the A429 Signal Viewer window.

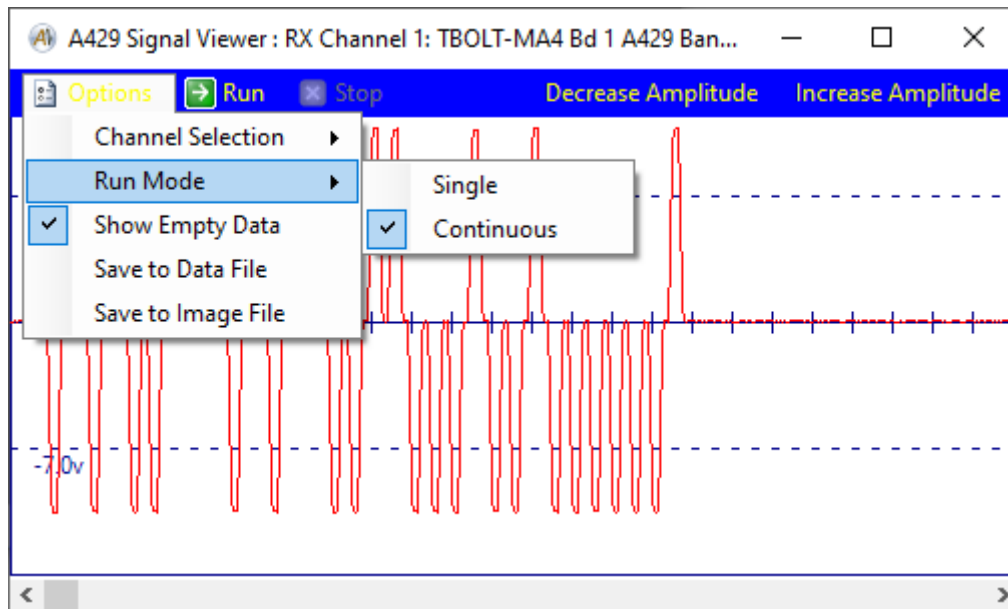

The menu-strip provides the “Options” pull-down menu to select Channel (receive channel 1 or 2), Run Mode (Single or Continuous), Show Empty Data check box and Save waveform to file. If you save to a data file this can be used with a spreadsheet (explained below). If you save to a JPG file this saves a screen shot of this window. The Show Empty Data is used when the A429 labels are transmitted slowly there can be flicker since the signal capture will time out and have all zero volt data, if this is unchecked it will not update the signal viewer if all of the A429 signal data elements are zero.

The “Run” button starts the signal capture. The “Stop” button stops the signal capture. The “Colors” pull-down menu provides options to change the background color (default is white), foreground color (default is dark blue), and signal color (default is red).

On the right side of the menu strip two buttons are provided to decrease or increase the displayed amplitude of the signal. The voltage reference lines (dashed lines) are marked with the voltage value based on the amplitude scale setting.

WARNING: The voltage scale is an estimate that should be accurate to within 1V. Use an oscilloscope for more accurate measurements.

The vertical tick-marks on the zero-voltage line indicate time in 20 microsecond steps – each tick-mark represents 20 microseconds.

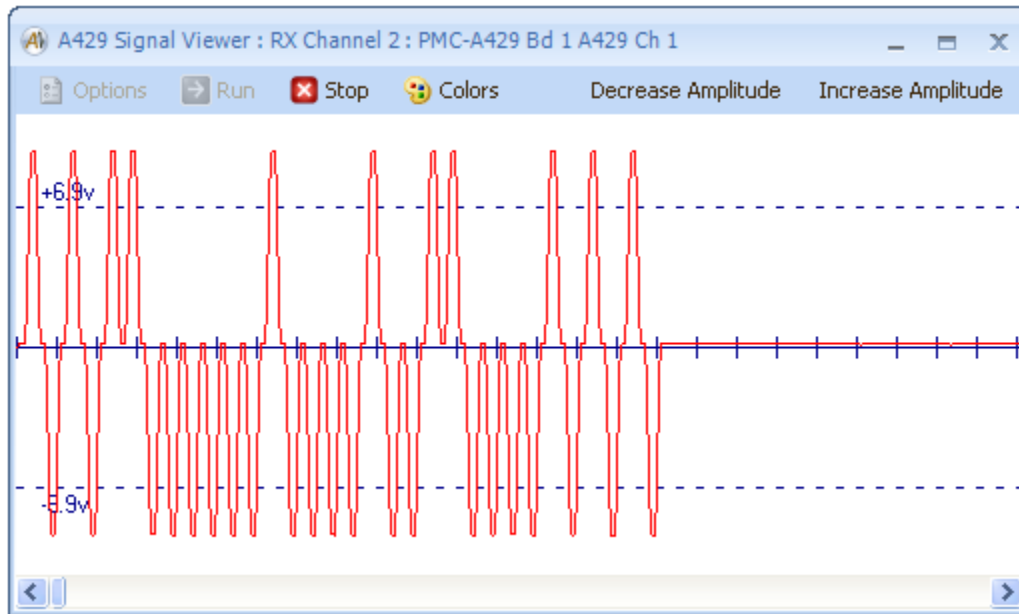

This shows a high-speed (100 KHz bit rate) A429 signal.

The Signal Viewer will capture 4096 samples at a rate of 1 MHz, or 1 microsecond per sample. Therefore the sample buffer contains 4096 microseconds of data. Each sample is an 8-bit value representing the differential voltage on the A429 channel, where the maximum value is 22.17 volts (+ or – 11.08 volts). The horizontal scroll-bar at the bottom of the window allows you to move through the 4096 microsecond data buffer to view any part of the captured signal. Under Options, a selection is provided for **Save to Data File** – this will save the 4096 samples to a text file where each sample is a value from 0 to 255, a value of 0 represents -11.08 volts and a value of 255 represents +11.08 volts. This can be used with a spreadsheet to display the waveform as a chart.

Note that you can also resize the window to display a larger portion of the buffer.



This shows a low-speed (12.5 KHz bit-rate) A429 signal.

WARNING: The Signal Viewer does NOT replace a calibrated oscilloscope for voltage or timing measurements on the A429 channel. The Signal Viewer provides simple voltage and timing scale markers. If more precise information is needed about the electrical signal a real oscilloscope should be used.

Data Table

The A429 RX Data Table will display all labels for all receive channels in a tabular format. **If the device is not enabled for full analyzer operation the Data Table feature is disabled.**

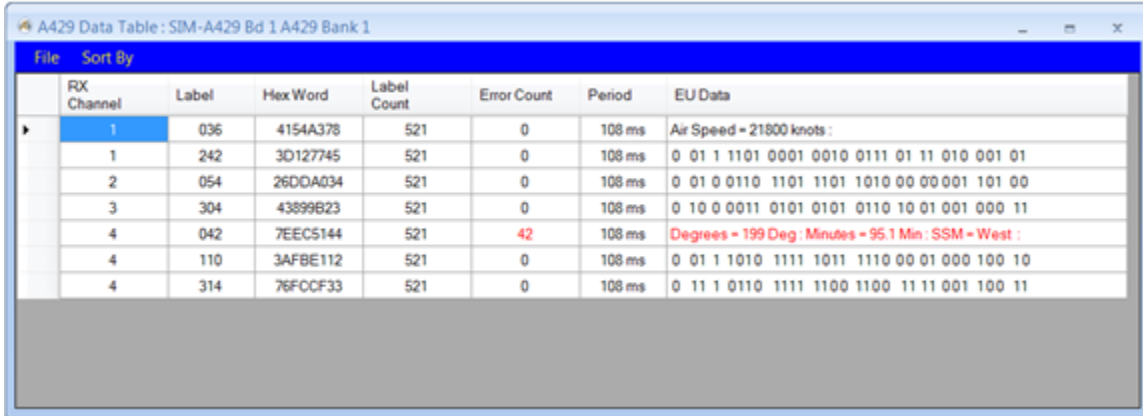

RX Channel	Label	Hex Word	Label Count	Error Count	Period	EU Data
1	036	4154A378	521	0	108 ms	Air Speed = 21800 knots :
1	242	3D127745	521	0	108 ms	0 01 1 1101 0001 0010 0111 01 11 010 001 01
2	054	26DDA034	521	0	108 ms	0 01 0 0110 1101 1101 1010 00 00 001 101 00
3	304	43899B23	521	0	108 ms	0 10 0 0011 0101 0101 0110 10 01 001 000 11
4	042	7EEC5144	521	42	108 ms	Degrees = 199 Deg : Minutes = 95.1 Min : SSM = West :
4	110	3AFBE112	521	0	108 ms	0 01 1 1010 1111 1011 1110 00 01 000 100 10
4	314	76FCF33	521	0	108 ms	0 11 1 0110 1111 1100 1100 11 11 001 100 11

The menu-strip item “Sort By” allows you to select “Label” (default) or “Label/SDI”. If Label is selected the table shows one label per row. If Label/SDI is selected the table shows one Label/SDI combination per row.

The table can be sorted by column by clicking the column header (on any of the columns).

The “EU Data” column displays the defined data fields for the label (defined in the EQID/Label Editor, and an EQID is assigned to the channel in the Channel Settings dialog). If the data is out of range (for BCD and BNR fields) it is shown in red. If you hover the mouse pointer over an entry for EU Data a tool-tip will show the Label name (for example, “Set Longitude”). If a data field has not been defined then this column will display the label contents in binary.

You can double-click on a row in the Data Table to display a Current Value window for the label – this will display the EU data (if defined for the label in the EQID/Label Editor and if an EQID is assigned to the channel). You can open Current Value windows for as many labels as desired.

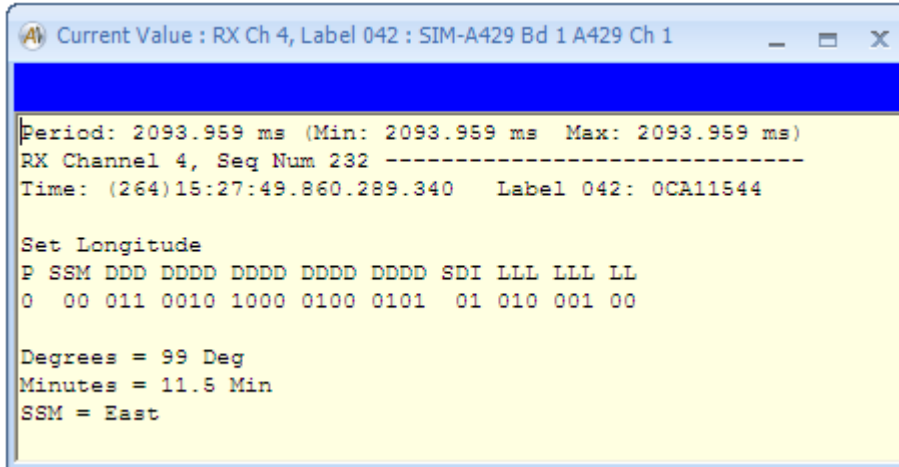

The “File” selection on the menu strip in the A429 Data Table will bring up a dialog-box that allows you to archive data to an RXP file.

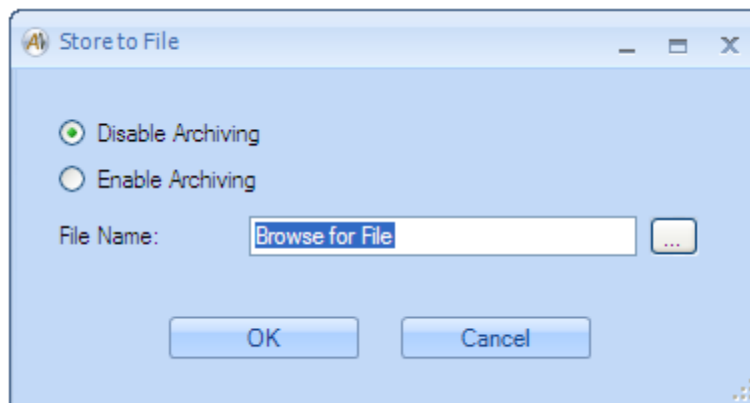

If you enable archiving and select a file name, then the A429 Data Table will write a RXP to the file for each label that is updated in the Data Table. This records a snapshot of the current (most recent) value for the label. The Data Table updates approximately twice per second, so data will be written to the file at about 2Hz.

Transmit Tools

The A429 Transmit Tools control all Transmit channels for the A429 device.

TX Control

The “TX Control” button will bring up the TX Control Panel for the selected A429 device. This is the main window for all Transmit channel operations for the device.

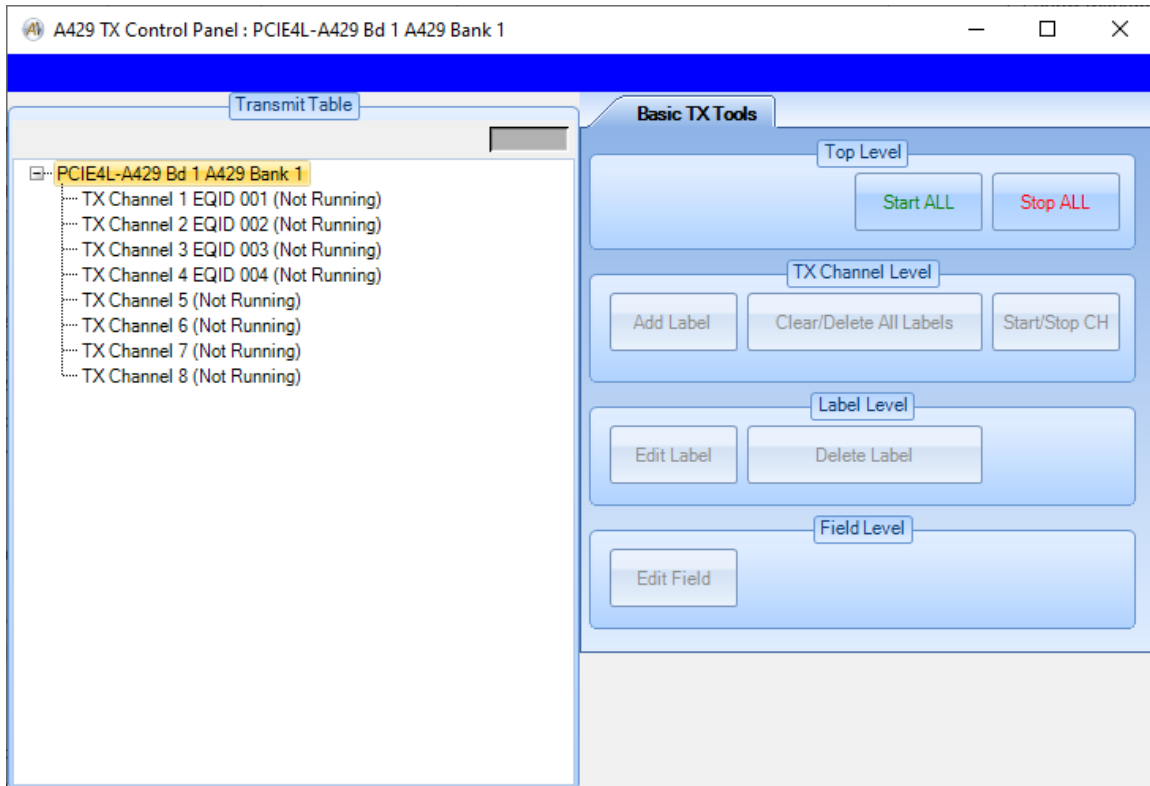

The TX Control Panel provides a tree-view on the left that displays the Transmit Table by channel. Controls are provided on the right. The controls are organized by functional level – Top Level, TX Channel Level, and Label Level.

Note that if you have assigned EQID numbers to the channels (in the A429 Channel Settings) then these are displayed in the tree node for the TX channel. If you add labels to the transmit list for the channel that are defined for the assigned EQID, then these labels will be displayed with sub-nodes for the fields defined for the label.

TX Control Panel – Top Level

The following shows what the TX Control Panel looks like at the top level:

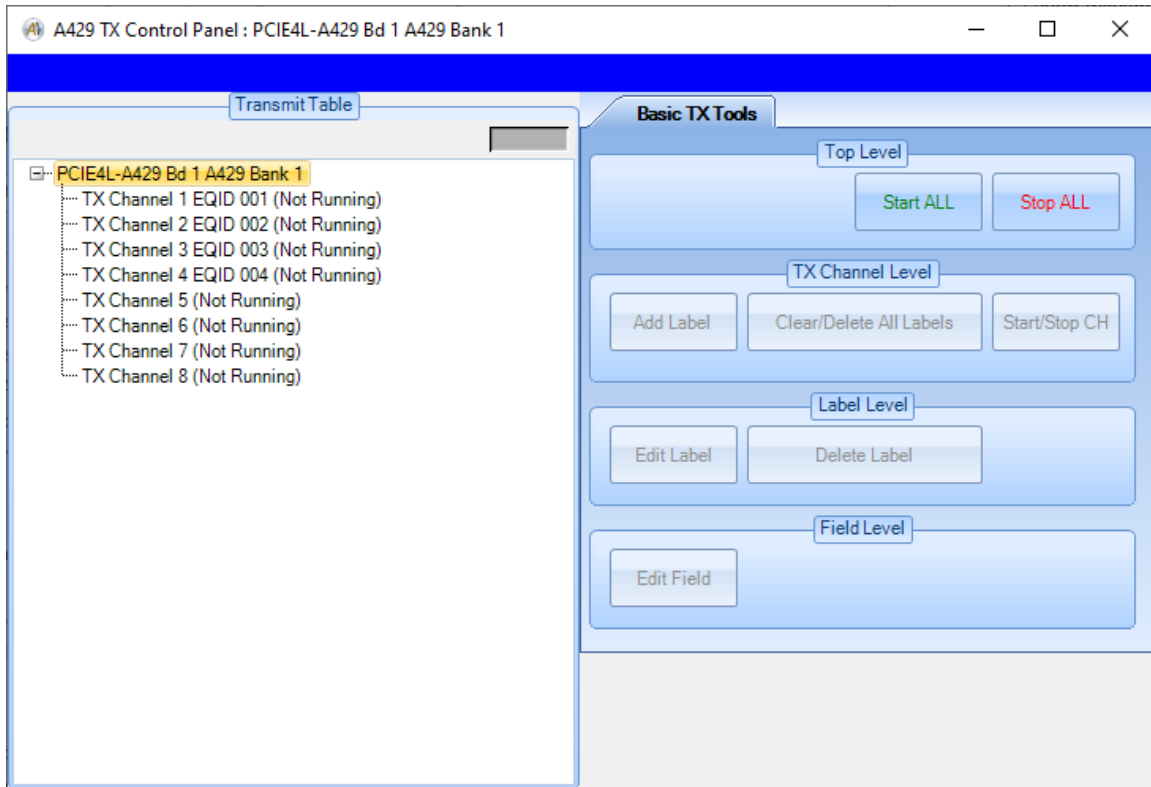

The top level controls allow you to start all TX channels or stop all TX channels.

TX Control Panel – TX Channel Level

If a TX channel node is selected, the TX channel level controls will be enabled.

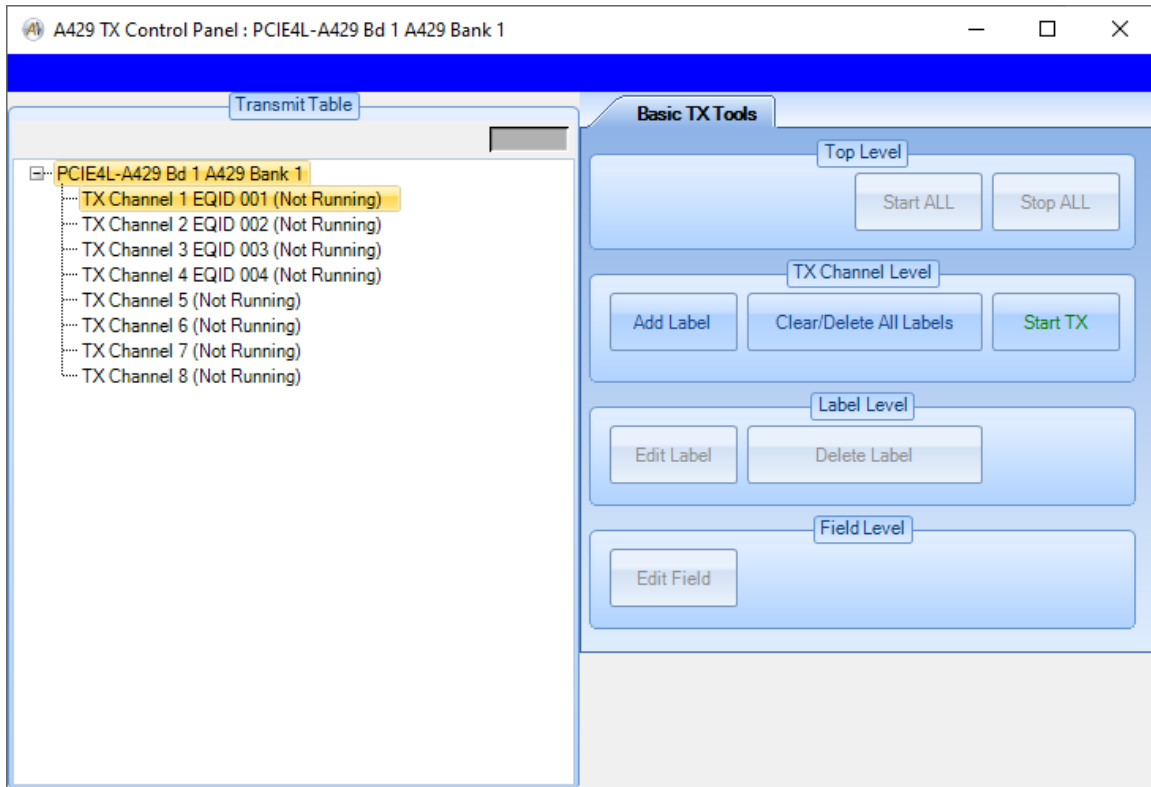

The TX channel level controls allow you to add labels to the channel (maximum of 256 labels per TX channel), clear/delete all labels for the channel, or to start/stop transmission for the selected channel.

The “Start TX” button will start the selected TX Channel. This button changes to “Stop TX” when the TX Channel starts running.

The “Stop TX” button will stop the selected TX Channel. This button changes to “Start TX” when the TX Channel stops running.

The “Add Label” button will bring up the following dialog-box:

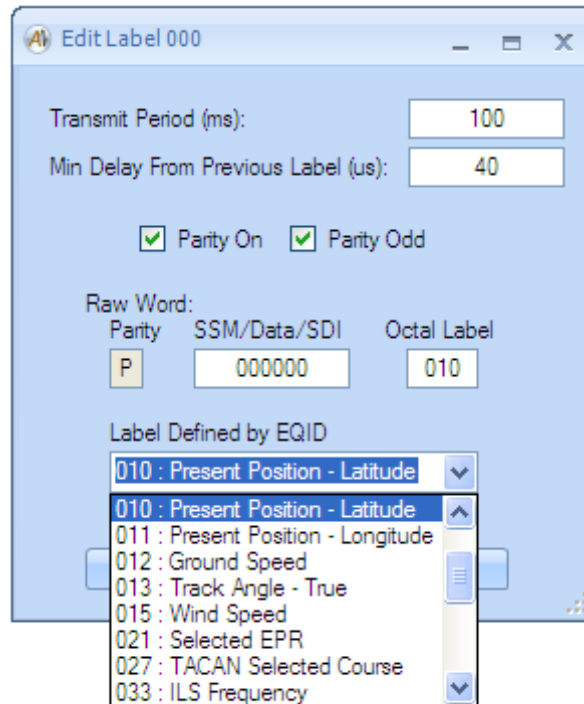

This allows you to define a label to be transmitted and its associated timing information.

The transmit period will be the time in milliseconds between transmissions of this label. For example, a transmit period of 100ms will cause the label to be sent at a 10 Hz rate. The transmit period is independent for each label in the transmit table for the channel, so you could have one label at 100ms, another label at 127ms, another label at 250ms, etc.

The software will automatically set the minimum delay time from previous label to the minimum time allowed (4 bit-times for the bit-rate selected for the channel, which is 40 microseconds with a 100 KHz bit rate), but you can change this to a higher value if desired.

Check-boxes are provided to control the parity bit. The default is odd parity (both “Parity On” and “Parity Odd” checked). If you uncheck “Parity On” then parity will not be generated. If “Parity On” is checked and “Parity Odd” is unchecked then even parity will be generated.

The “SSM/Data/SDI” field is the upper 24 bits of the A429 word (six hex digits). The “Octal Label” field is the lower 8 bits of the A429 word (3 octal digits). The parity bit (bit 31) will be automatically set or cleared for odd parity.

If an EQID has been assigned to the TX channel, a combo-box allows the user to select from a list of Labels defined for the EQID. This only affects the Label number, does not affect the SSM/Data/SDI field.

Right-Clicking on a TX Channel entry on the Transmit Table will bring up a context menu with Copy, Cut and Paste. Copy will copy all of the messages of the channel into an internal clip board for the dialog. Cut will copy all of the messages of the channel into the internal clip board like the Copy entry will but it will also delete all entries from the channel. The Paste will put all of the messages in the clip board into the currently selected TX Channel before the first message of the TX Channel if one exists.

TX Control Panel – Label Level

If a label node is selected, the label level controls will be enabled.

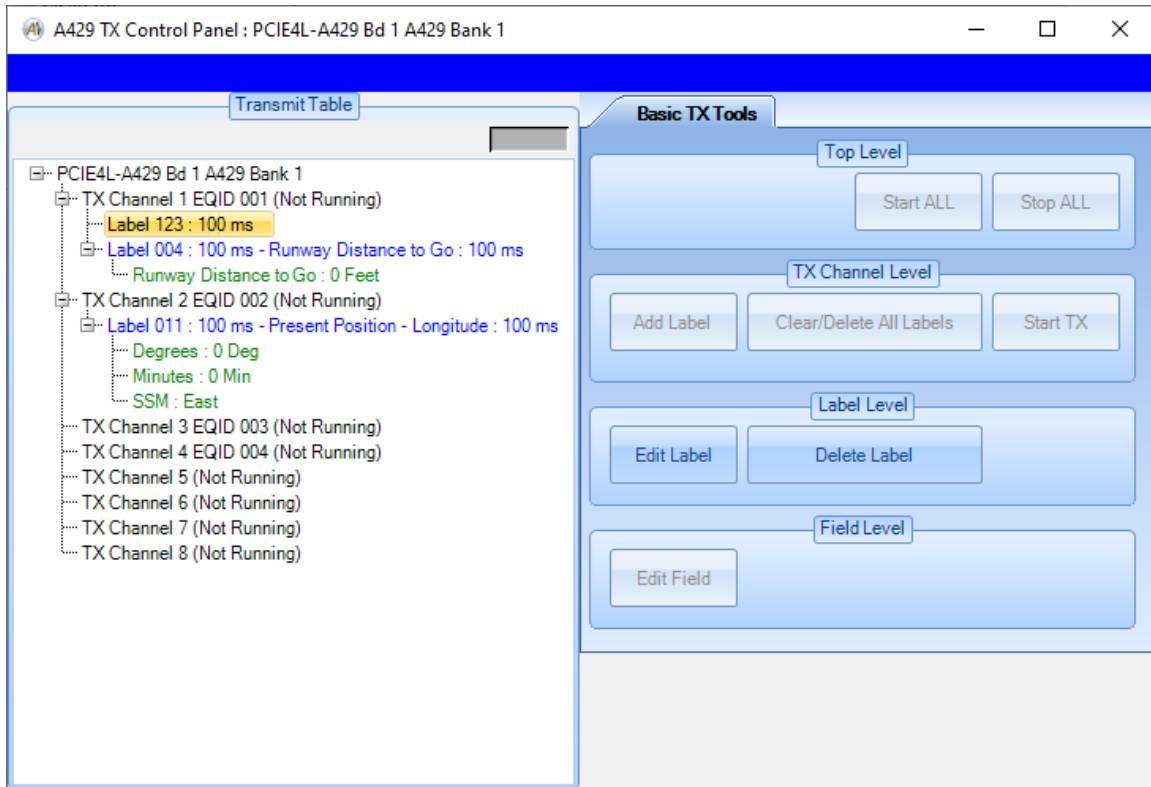

The label level controls allow you to edit or delete the selected label. The label-level “Edit Label” button allows you to edit the raw binary bits in the label. This is the same dialog-box that you saw with the “Add Label” button.

Note that if a label is defined for the EQID assigned to the channel, the Label node in the tree is displayed in blue along with the name assigned to the label. Any fields defined for the label are shown as sub-nodes in green.

TX Control Panel – Field Level

If a field node is selected, the field level controls will be enabled. The “Edit Field” button allows you to enter data in Engineering Units (EU) as defined for the field (defined in the EQID/Label Editor).

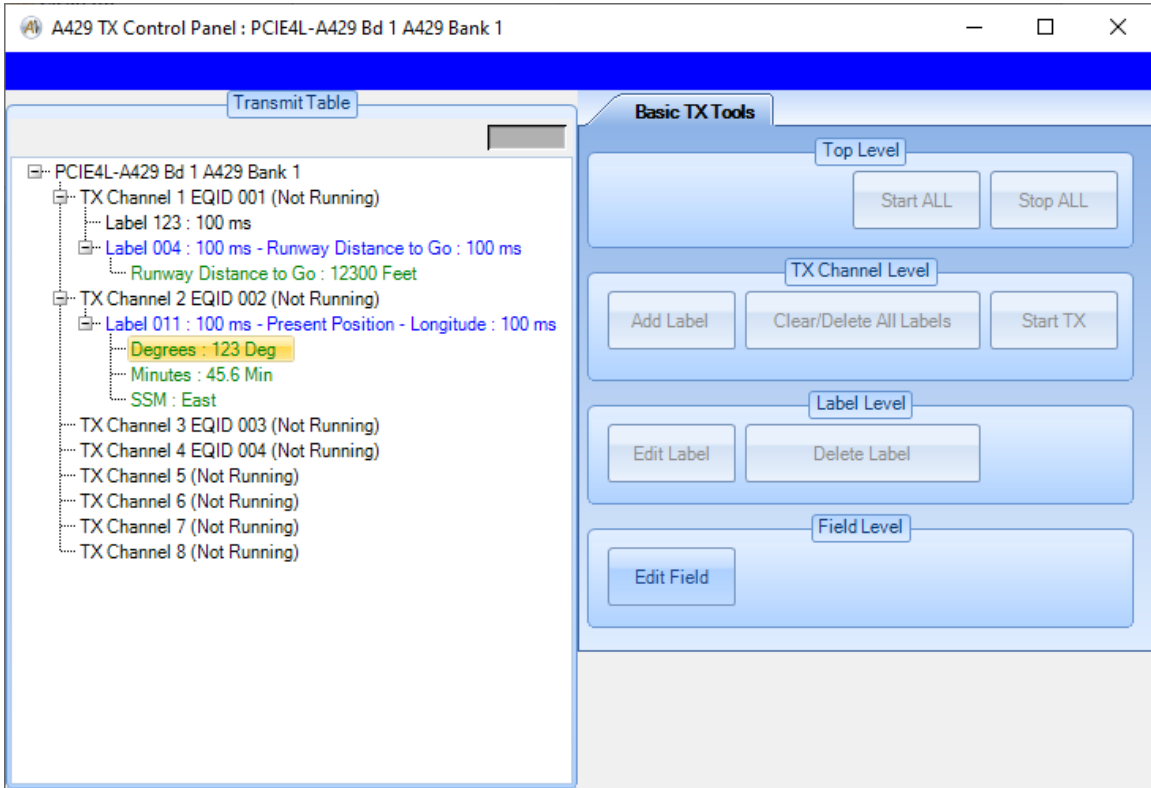

BCD and BNR fields are displayed with the field name, the current value of the field (which you can edit), the units for the field, and the allowed range for the field.

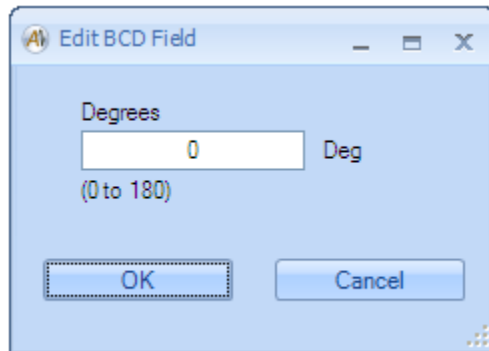

COD fields are displayed with the field name and a combo-box that allows you to select a value for the field.

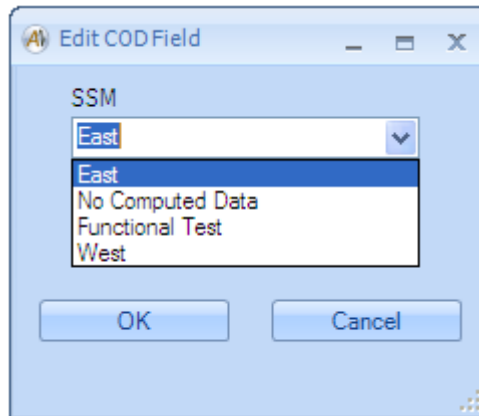

Once you have defined the desired labels you can either start specific TX channels (from the TX channel level controls) or start all TX channels (from the top level controls).

Playback Tools

The Playback tools provide controls for Playback operation. Playback allows **AltaView** to read RXP files (recorded by the RX Monitor) and replay them onto the A429 bus. **These tools are disabled if the device is not enabled for full analyzer operation.**

Enabling Playback

Enabling Playback is done by selecting the “Use TX Channels in PLAYBACK mode” option in the Channel Settings window. Selecting this option enables Playback mode on ALL TX channels. Note that you CANNOT run Playback and NORMAL TX operations simultaneously.



Playback Control

The “PB Control” button will bring up the Playback Control Panel for the selected A429 Bank. This is the main window for all Playback operations for the Bank.

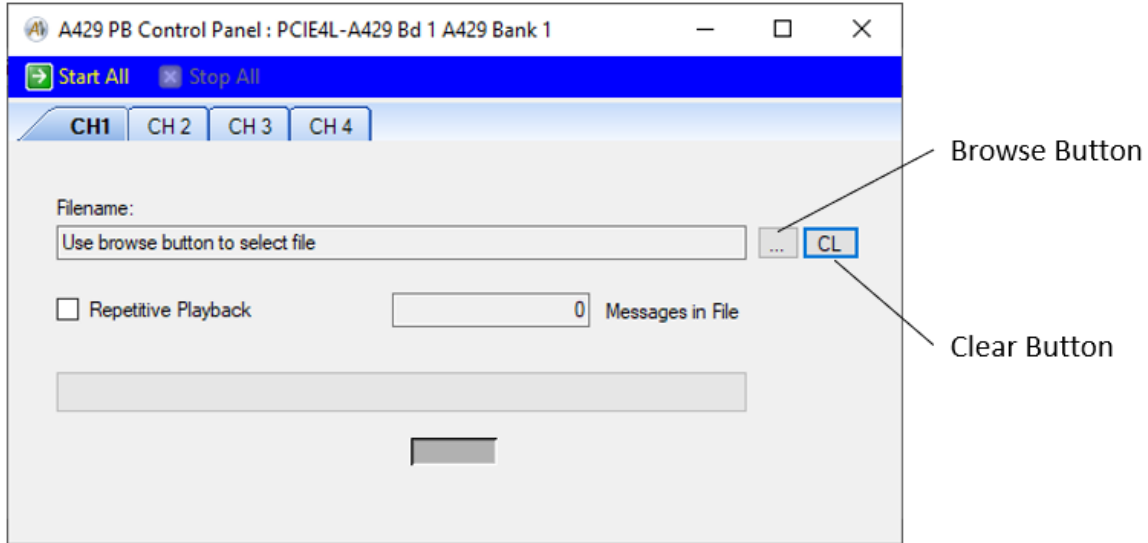

A channel tab will automatically be created for each available PB channel. Choose the desired Playback channel(s) to setup Playback information. The “browse” button (located to the right of the Filename text-box) brings up a dialog-box that allows you to select a RXP file for playback. **YOU MUST SELECT A RXP FILE TO ENABLE THE CONTROLS IN THIS WINDOW.**

If you do not select a RXP file for a given channel then that channel will be inactive for playback. If you want to disable a channel that you previously selected a file for, click the CLR (Clear) button.

If you recorded a RXP file with data from multiple Receive channels and want to play back this data on multiple Transmit channels, you will want to create separate files for each Transmit channel. This can be done with the A429 RX File Viewer. The “Convert” tool in the File Viewer can be used to filter the data by RX channel and generate separate RXP files for each channel.

As an example, we first recorded a file called “A429_AllChannels.rxp” and opened this file in the RX File Viewer.

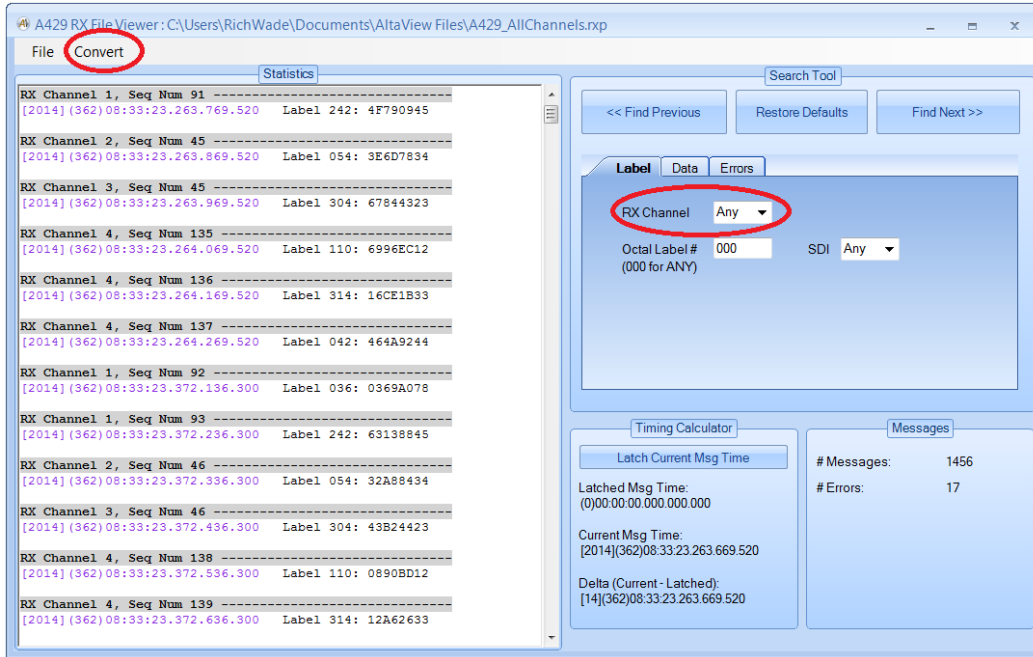

Note that we have circled the “Convert” tool and the “RX Channel” in the Search Tool. The settings in the Search Tool can be used as a filter for the Convert tool. First select the desired RX Channel in the Search Tool – we will select channel 1 for this example. Click on “Convert” and select “To RXP (binary)”.

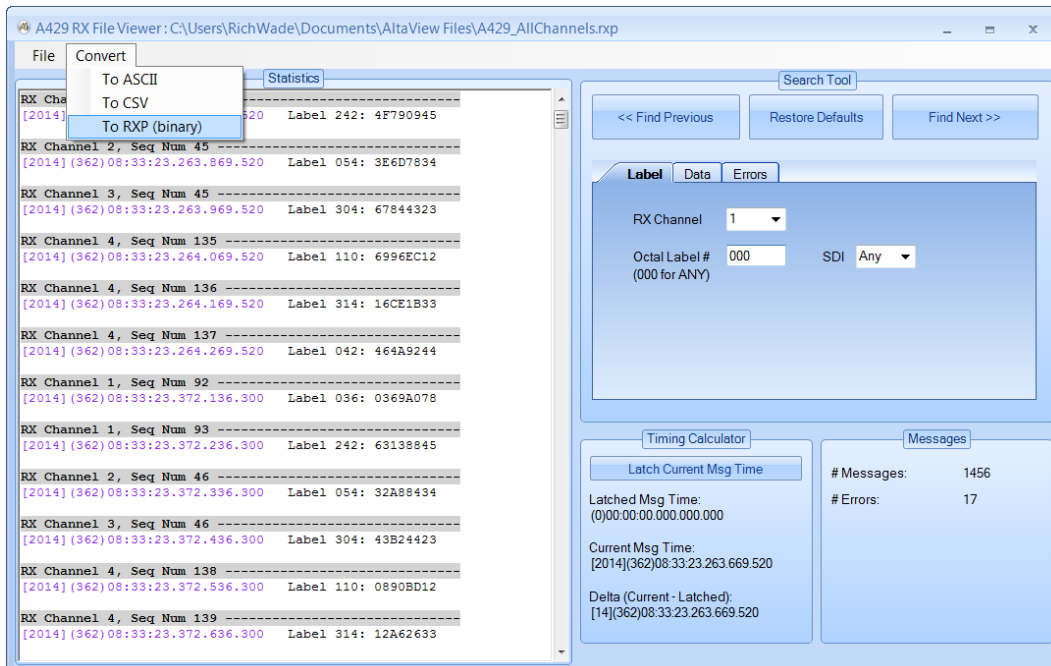

This gives us the Convert to RXP dialog box. Use the browse button to specify the new file to be created (with the filtered data). I will use the file name A429_Channel_1.rxp. Under “Message Filtering” select “Filter using search settings”. Now click OK to create the new file.

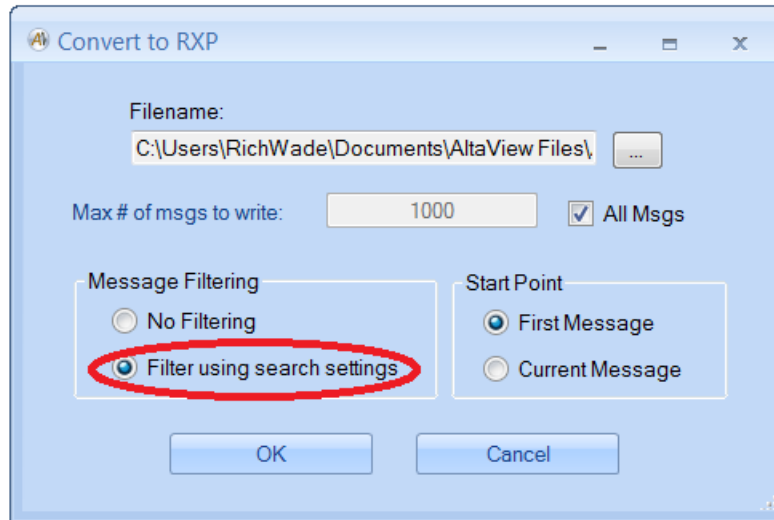

Now we can open the new file with the RX File Viewer to verify that it only has data for Channel 1.

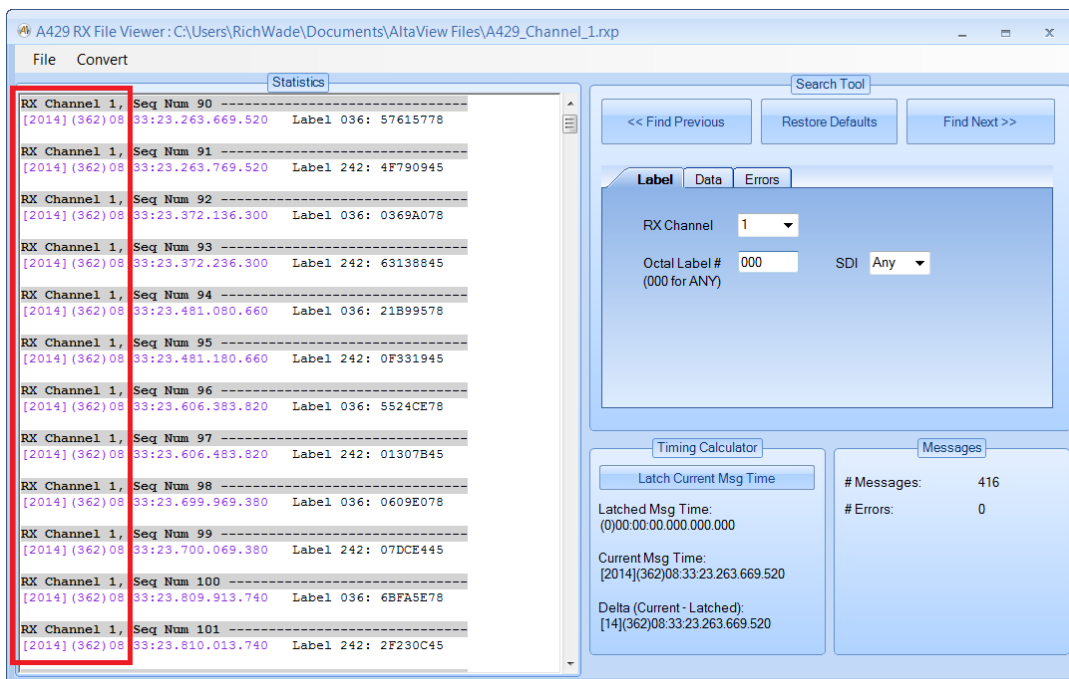

You can repeat this process to create separate files for the other channels.

When the RXP file is selected the number of messages (RXP records) in the file will be displayed.

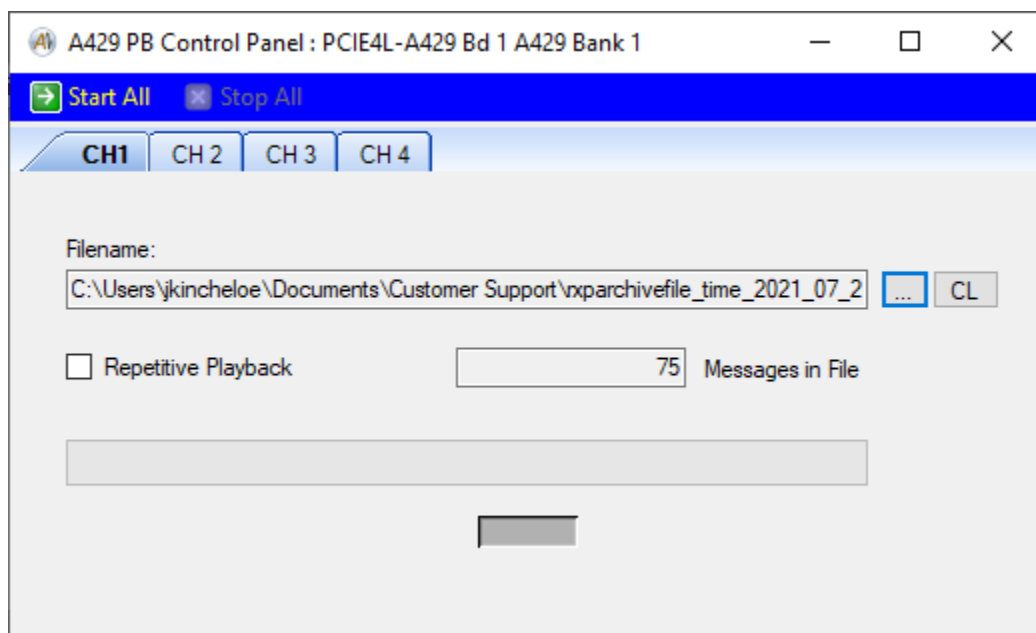

The "Start All" button on the menu strip will start transmission of messages on the A429 bus for all channels in the bank that have an RXP file defined. Once playback is started, this button will be disabled until the "Stop All" button is selected or after ALL channels within the bank have completed their playback operation.

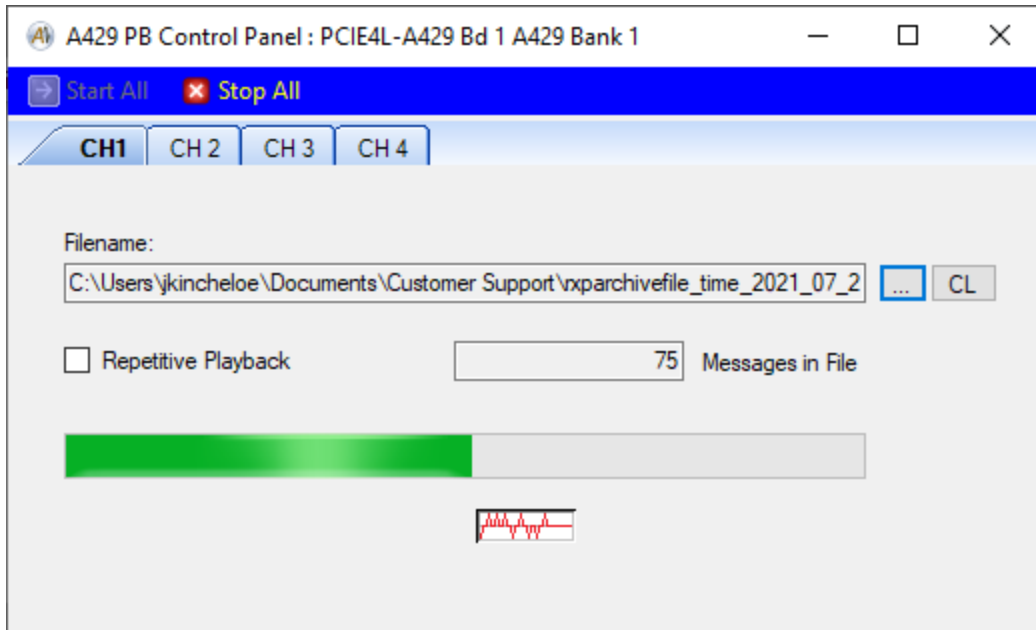

The progress bar and activity indicator in the middle of the window (for each channel) will show whether or not playback is running and will show how much of the file has been played back. If “Repetitive Playback” is not checked, then playback will automatically stop when the end of the RXP file is reached.

If “Repetitive Playback” is checked then when playback is started it will run continuously, playing back the selected file repeatedly, until stopped by the user. Note: Repetitive Playback will not start again on a given channel until ALL channels within the bank have completed their playback operation.

Note that you CANNOT run Playback and NORMAL TX operations simultaneously.

Synchronous Playback

The EXTERNAL CLOCK feature can be used to perform synchronous playback on multiple A429 channels and multiple boards. This allows multiple channels to start playback simultaneously and to stay synchronized because all channels use the same clock to drive the playback interval timer.

1. Configure the board-global external clock settings for all boards to be used in the synchronous playback. This is done by opening the “Global” device for the board and opening the Board-Global Control Panel – select the desired external clock options here. **DO NOT ENABLE THE OUTPUT CLOCK AT THIS POINT.**

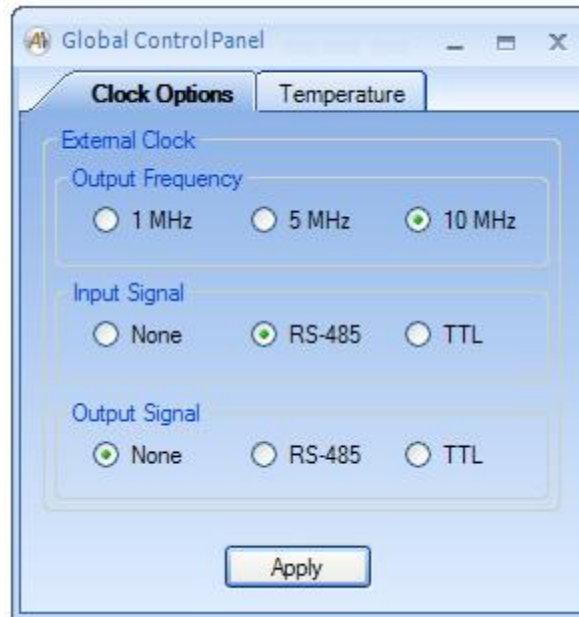

2. Configure the time options for all A429 channels to be used in the synchronous playback. This is done by opening the A429 bank device and opening the "Time Options" dialog-box for the device. Select the "External Clock" and select the clock frequency that matches the frequency of the external clock (selected in step 1 above).

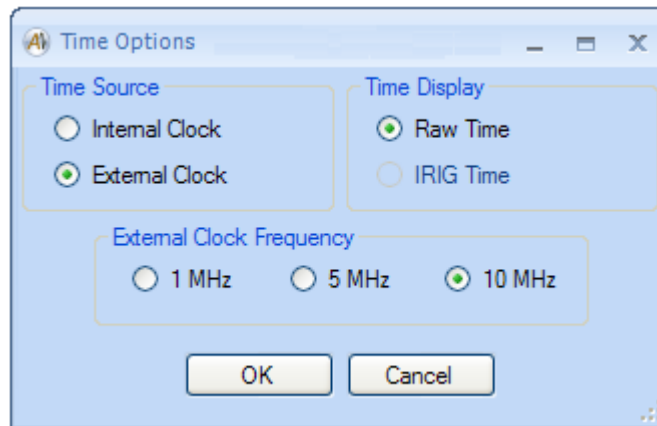

3. Configure playback for all A429 channels on each Bank to be used in the synchronous playback. This is done by opening the PB Control Panel for each Bank, selecting the desired RXP file for playback for each channel, and clicking on the "Start All" playback button. **Note that playback will not start sending any messages until the external clock is started.**

4. When all the A429 channels are ready, go to the Board-Global Control Panel for the board that will generate the external clock signal and enable the output clock (and hit “Apply”). **This starts playback on all configured A429 channels simultaneously and drives them all with the same clock.**

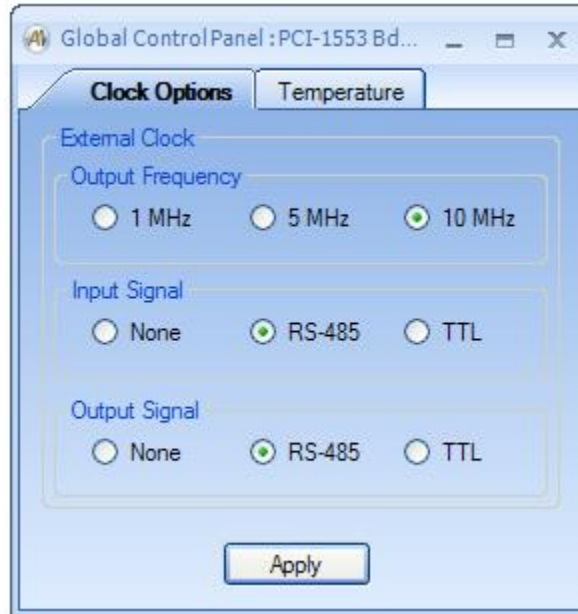

NOTE: Repetitive playback will not be synchronous after the first execution because the playback on each channel is restarted from the software level for repetitive playback, and therefore playback is not restarted on all channels simultaneously. Therefore, if you need the playback to be synchronous for multiple channels you should NOT use repetitive playback.

Chapter 5 – WMUX Tools

The “WMUX” tab on the ribbon-bar provides tools for the F-16 Weapon Multiplex (WMUX) bus protocol.

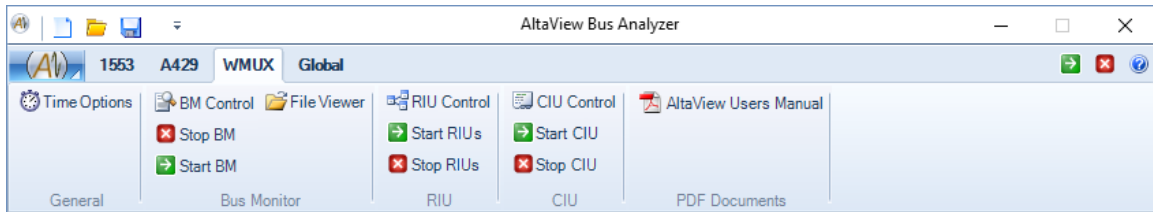

General Tools

The General tools provide basic things like time options. ***These tools are disabled if the device is not enabled for full analyzer operation.***

Time Options

The “Time Options” button will bring up the following dialog box:

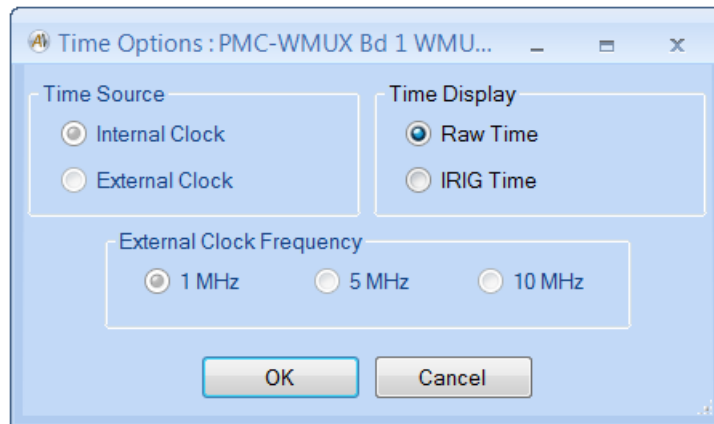

This allows you to select the time source (internal clock or external clock) and time display (raw or IRIG). External clock options are currently not supported for WMUX, only Internal Clock is used. You can use this with either Raw Time or with IRIG Time. If “IRIG Time” is selected for Time Display, the WMUX BM will convert the internal time-stamp to the corresponding IRIG time as messages are read from the board. A good IRIG input signal must be connected to the board and the board must be calibrated for this signal. Refer to the section on the Board-Global Control Panel in Chapter 2 for more information on IRIG calibration.

Bus Monitor Tools

The Bus Monitor tools provide controls for BM operation.

BM Control

The “BM Control” button will bring up the BM Control Panel for the selected WMUX device. This is the main window for all Bus Monitor operations for the device. ***If the device is not enabled for full analyzer operation, the Snapshot Viewer and message archiving features are disabled.***

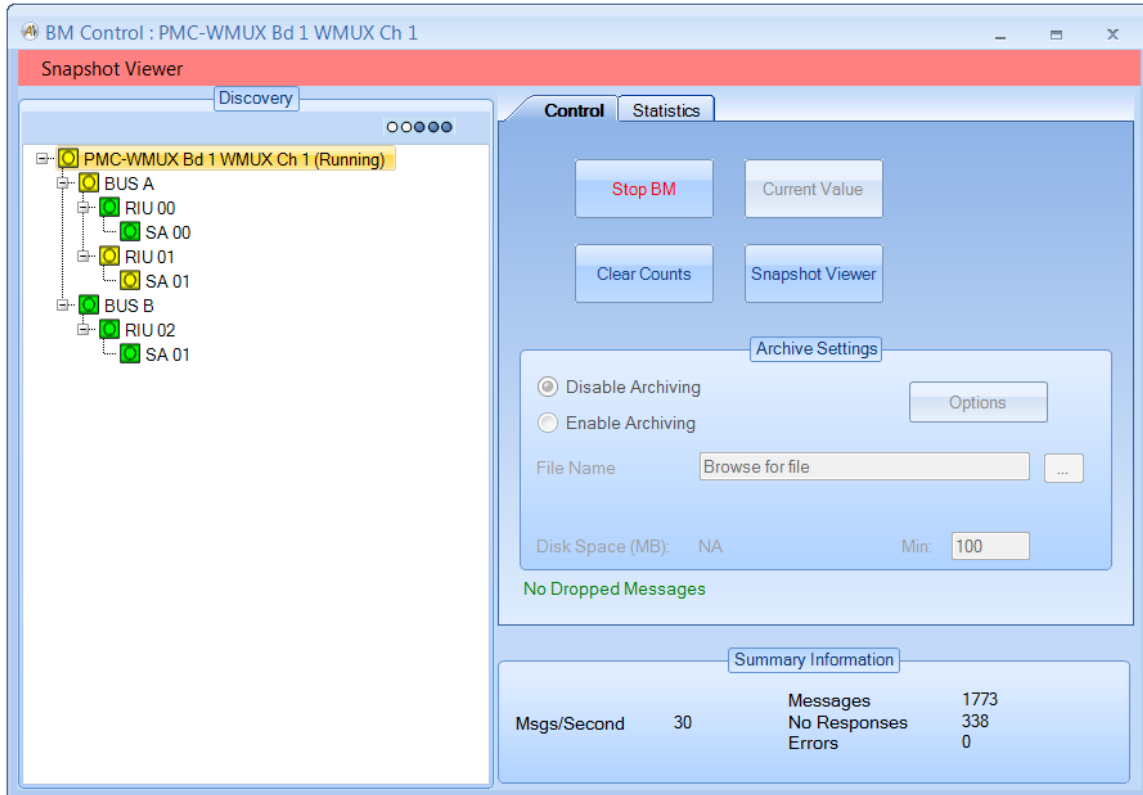

The BM Control Panel consists of the “Discovery” tree on the left and controls on the right. Summary information including message rate and message counts is provided on the lower right.

The discovery tree will populate itself as the bus monitor detects messages on the bus (if the bus monitor is running). The root of the tree is the WMUX Channel (device) and bus activity is represented by Bus, RIU, and Sub-Address. Each node in the tree has an “activity icon”, which is a square with a circle inside of it. The square represents past conditions and the circle represents the current condition. There are four colors representing possible conditions:

Gray = No Activity

Green = Activity with no errors

Yellow = Activity with no status response from the RIU

Red = Activity with protocol errors (parity, sync, etc.)

For example, if the activity icon is Red in the square and Green in the circle, this indicates that there was a protocol error sometime in the past but most recent activity had no errors.

WMUX BM Error Codes

The WMUX BM tools will report any errors detected in the messages. This is derived from the error flags in the CDP Status Word for each message. The following table lists the error codes you may see:

Error Code	Description
BIT	A bit-count error was detected – could be too few bits or too many bits in a word. This error can be caused by a Manchester encoding error (zero-crossing in the wrong place). It can also be caused by bus collisions (two terminals transmitting at the same time).
PARITY	A parity error was detected – WMUX expects to see odd parity on every word. A bit/encoding error can also cause parity errors.
TRUNCATED-MSG	A truncated message error was detected – the expected words did not complete and the message was truncated. This can happen if an error is detected and the CIU stops the message transmission to send a Master Reset.
NO-RESPONSE	A no-response error was detected – a command was sent to the RIU but the RT did not respond.
WRONG-RIU-RESPONSE	A wrong RIU address error was detected. A RIU responded to the command but the RIU response contained the wrong RIU address.

BM Discovery Tree

The discovery tree can be reorganized by the user. You can right-click on any node and select the options to “Move Up”, “Move Down”, or “Expand All”. The “Expand All” selection will expand all nodes below the node you right-clicked on.

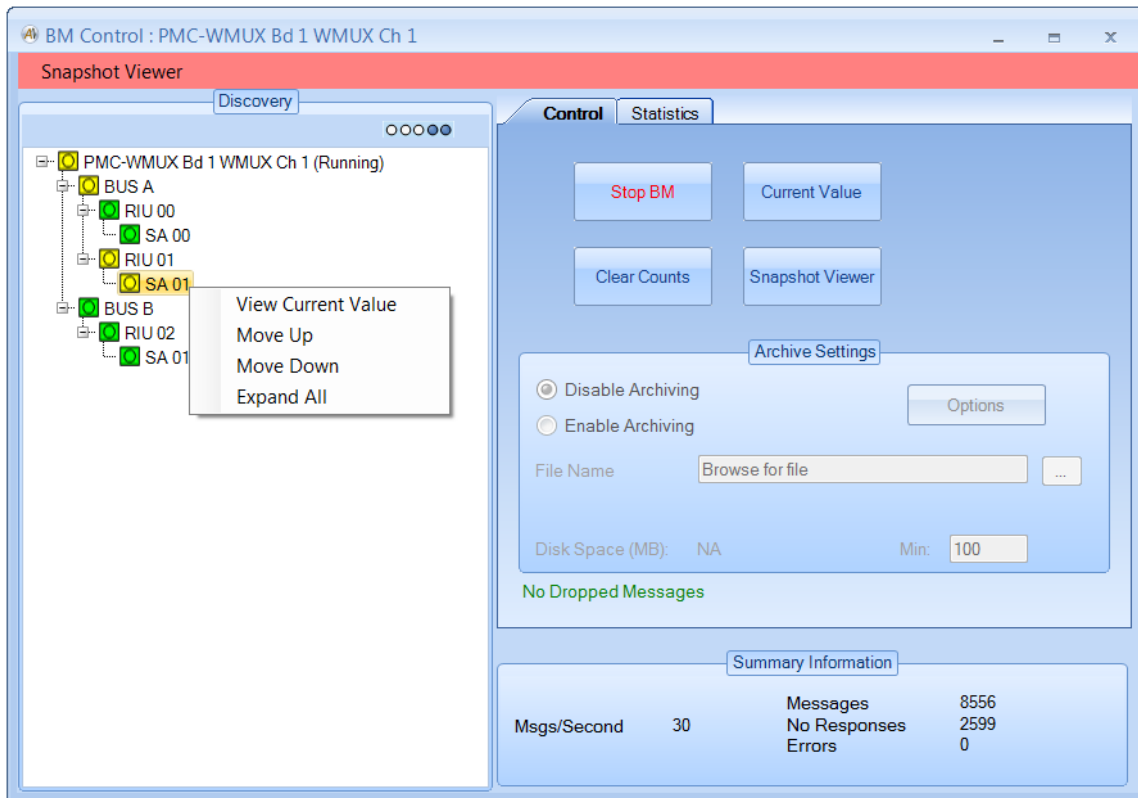

At the SA level, you can also select “View Current Value” to see the most recent message for that SA. This is identical to clicking the “Current Value” button in the “Control” tab. If you double-click on an SA node this will bring up the “Current Value” viewer for that SA.

NOTE – The “Current Value” shows the **most recent message for the selected SA**. This does not differentiate between Bus A or Bus B – just as a WMUX RIU does not differentiate between data on Bus A or Bus B. If you have messages to the same RIU/SA on both Bus A and Bus B then the Current Value viewer will show the most recent message for that RIU/SA on either bus.

Control Tab

The BM controls consist of tabs for Control and Statistics. The “Control” tab is shown here:

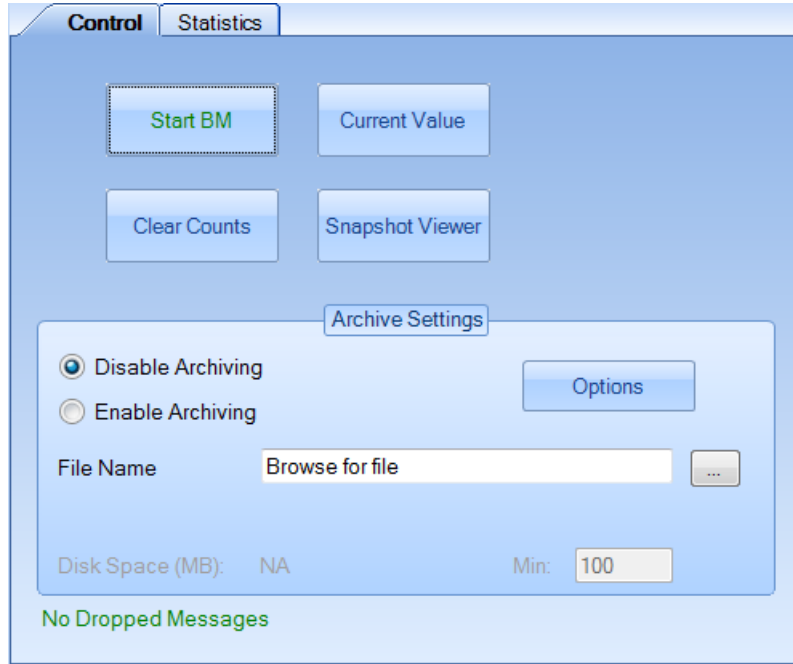

The “Start BM” button starts the bus monitor. When the BM is running, this changes to a “Stop BM” button. A text label below the Archive Settings panel indicates whether or not the BM has dropped any messages. Every message contains a “sequence number” which should increment by one on every message. If the BM sees a message that does not have the expected sequence number then it will indicate that messages have been dropped. Note that this sequence number is displayed as “Message Number” in the various BM views.

When the BM is not running the “Archive Settings” panel is enabled. You can enable or disable archiving to record messages to a data file, and of course you can specify the file name to store the messages to. If archiving is enabled and a valid file/path has been selected, the available disk space (in MB) is displayed. You can specify the minimum free disk space to preserve – if **AltaView** detects that the free disk space has dropped below the minimum value it will stop the bus monitor. The minimum free disk space defaults to 100 MB.

The “Options” button provides a dialog box where you can specify the desired archiving options.

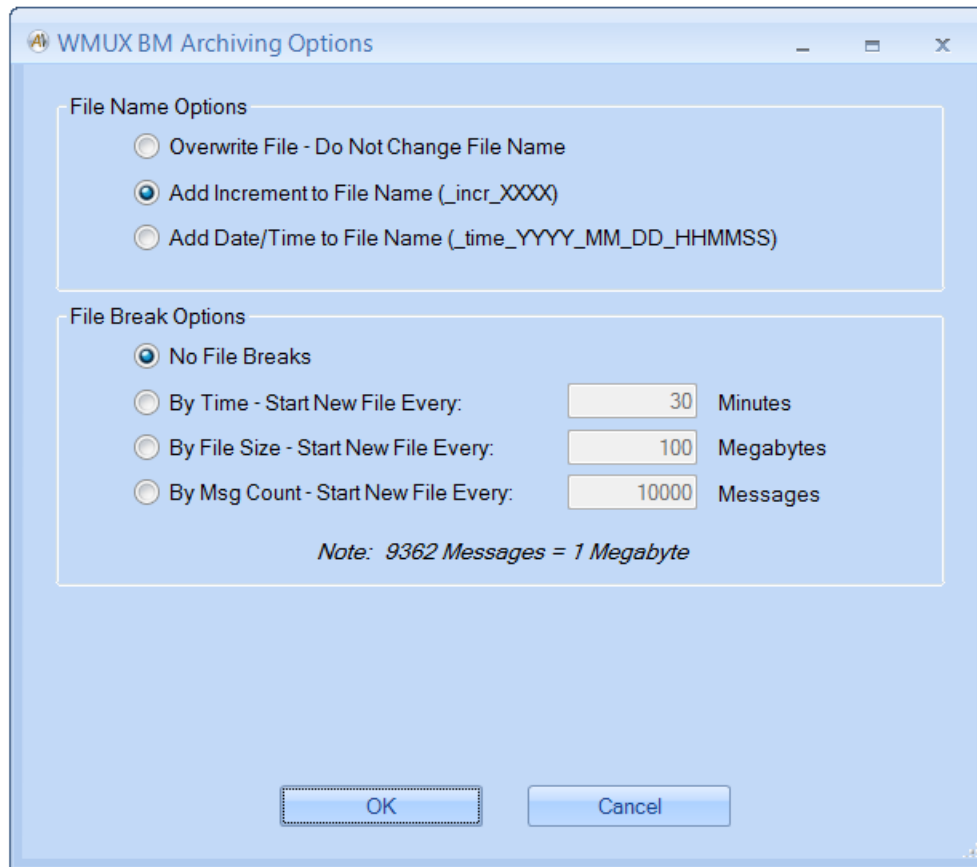

Under File Name Options, the option to “Add Increment to File Name” is selected by default – this prevents you from accidentally overwriting an existing file. If you do want to overwrite the file if it exists, you can use the “Overwrite File” option. You also have the option to add a date/time to the file name rather than an incrementing number.

The File Break Options allow you to specify the condition to close one archive file and open a new one. Note that you cannot do this if “Overwrite File” is selected. You can start a new file based on time in minutes, file size in megabytes, or number of messages.

If you enable archiving and start the BM, you will see an archiving indicator at the top of the Discovery panel (left of the “running” indicator) as shown here:

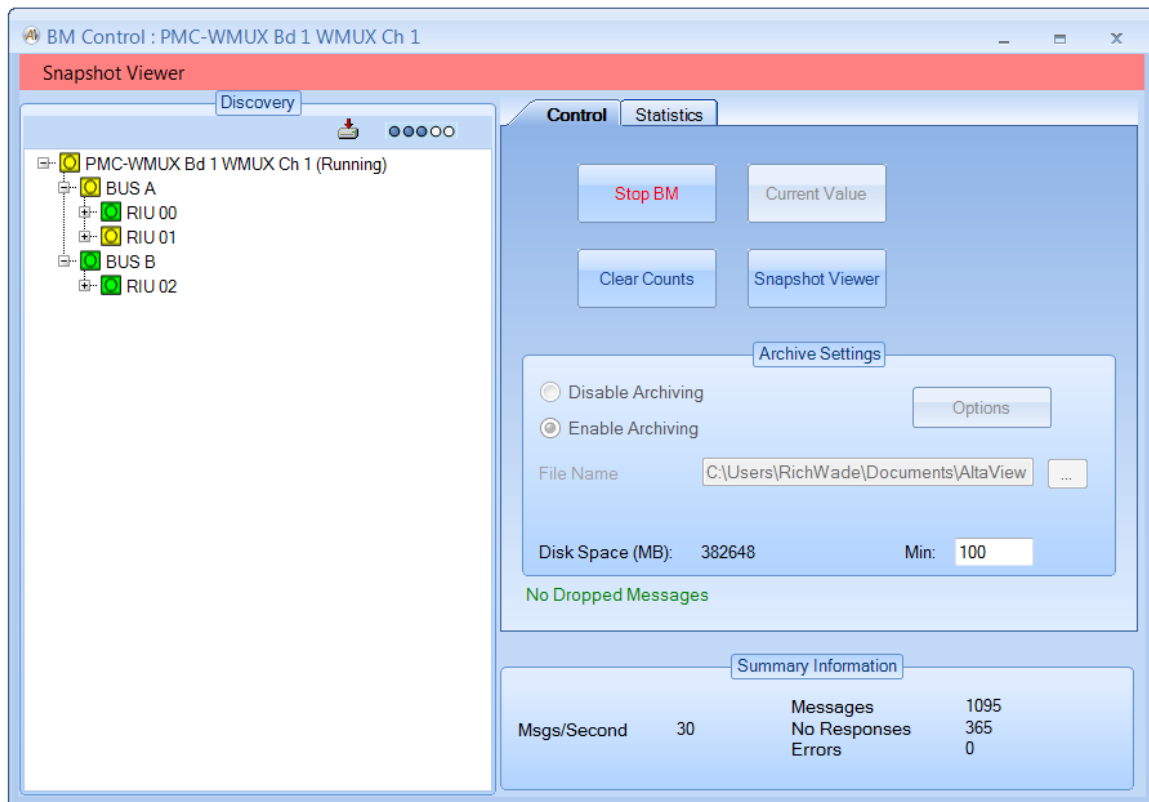

The “Clear Counts” button zeroes the message counters and clears the discovery tree. This can be useful if you want to clear any past conditions. The BM state is automatically cleared when the BM is started so old message counts etc. will not carry over to a new run of the BM.

BM Current Value Viewer

If a SA level node is selected in the discovery tree, then the “Current Value” button will be enabled. Either the “Current Value” button or the right-click option “View Current Value” will display the current value view for the selected SA.

NOTE – The “Current Value” shows the **most recent message for the selected SA**. This does not differentiate between Bus A or Bus B – just as a WMUX RIU does not differentiate between data on Bus A or Bus B. If you have messages to the same RIU/SA on both Bus A and Bus B then the Current Value viewer will show the most recent message for that RIU/SA on either bus.

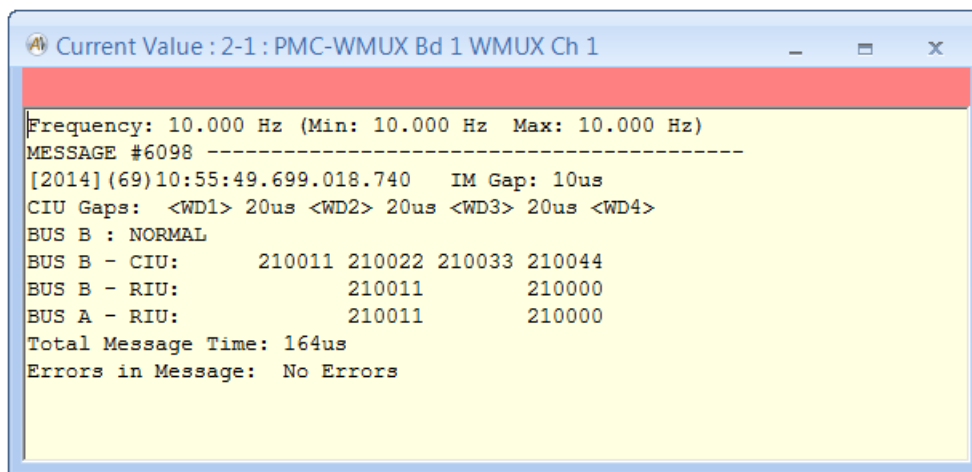

```
Current Value : 2-1 : PMC-WMUX Bd 1 WMUX Ch 1
Frequency: 10.000 Hz (Min: 10.000 Hz Max: 10.000 Hz)
MESSAGE #6098 -----
[2014] (69) 10:55:49.699.018.740 IM Gap: 10us
CIU Gaps: <WD1> 20us <WD2> 20us <WD3> 20us <WD4>
BUS B : NORMAL
BUS B - CIU:      210011 210022 210033 210044
BUS B - RIU:           210011      210000
BUS A - RIU:           210011      210000
Total Message Time: 164us
Errors in Message: No Errors
```

Note that the Current Value display shows frequency information as well as the most recent message. The first line shows the current frequency (determined from the period between the last two messages for this SA), the minimum frequency, and the maximum frequency. This can be very useful for verifying that messages occur at the rates they are supposed to as defined for the system.

BM Snapshot Viewer

The “Snapshot Viewer” button allows you to examine a snapshot of up to 1000 messages from BM memory. The BM Snapshot Viewer is shown below:

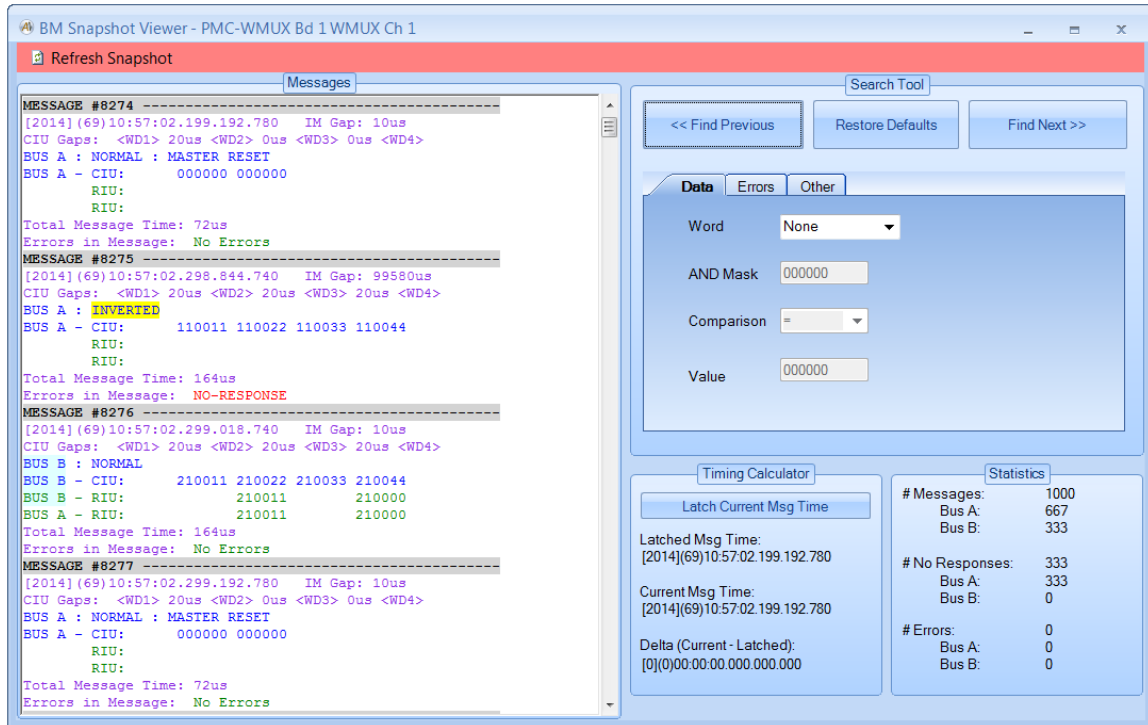

A menu-strip provides the option to “Refresh Snapshot” – Will update the display with the current messages in the BM Snapshot Buffer (up to 1000 messages). These are the most recent messages seen by the BM. The messages are displayed on the left in a scrollable window.

```

Message Number      Time Stamp      Inter-message gap
-----
MESSAGE #8276 -----
[2014] (69)10:57:02.299.018.740  IM Gap: 10us
CIU Gaps: <WD1> 20us <WD2> 20us <WD3> 20us <WD4>
Bus --- BUS B : NORMAL
      BUS B - CIU:      210011 210022 210033 210044 ----- CIU Words
      BUS B - RIU:      210011      210000 ----- RIU Words
      BUS A - RIU:      210011      210000
      Total Message Time: 164us
      Errors in Message: No Errors
                                     Message Time

```

The message display shows time-stamp and gap information in magenta, CIU information in blue, and RIU information in green, as shown above. Errors will be shown in red.

On the right side of the Snapshot Viewer you have a Search Tool, a Timing Calculator, and a Statistics panel.

The Statistics panel provides basic counts for the current set of messages in the snapshot – number of messages, no-responses, and errors by bus (A or B).

The Timing Calculator is used to measure the time difference from one message to another. The first (top) message displayed in the “Messages” panel is the current message – you will see that the Timing Calculator always displays the “Current Msg Time” as the timestamp of the first message in the “Messages” panel. If you click on the button to “Latch Current Msg Time” the Timing Calculator will save the timestamp of the current message as the “Latched Msg Time”. Now as you move through the messages the “Current Msg Time” will change and the Timing Calculator will update the “Delta (Current – Latched)” time. As the name indicates, this delta time is the result from subtracting the latched time from the current time. Negative delta times are shown in red.

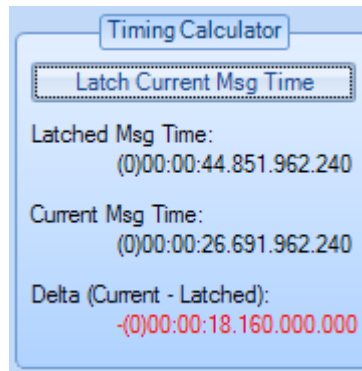

Note that the “Latched” message is shown with a dark yellow background for the message number line in the message display.

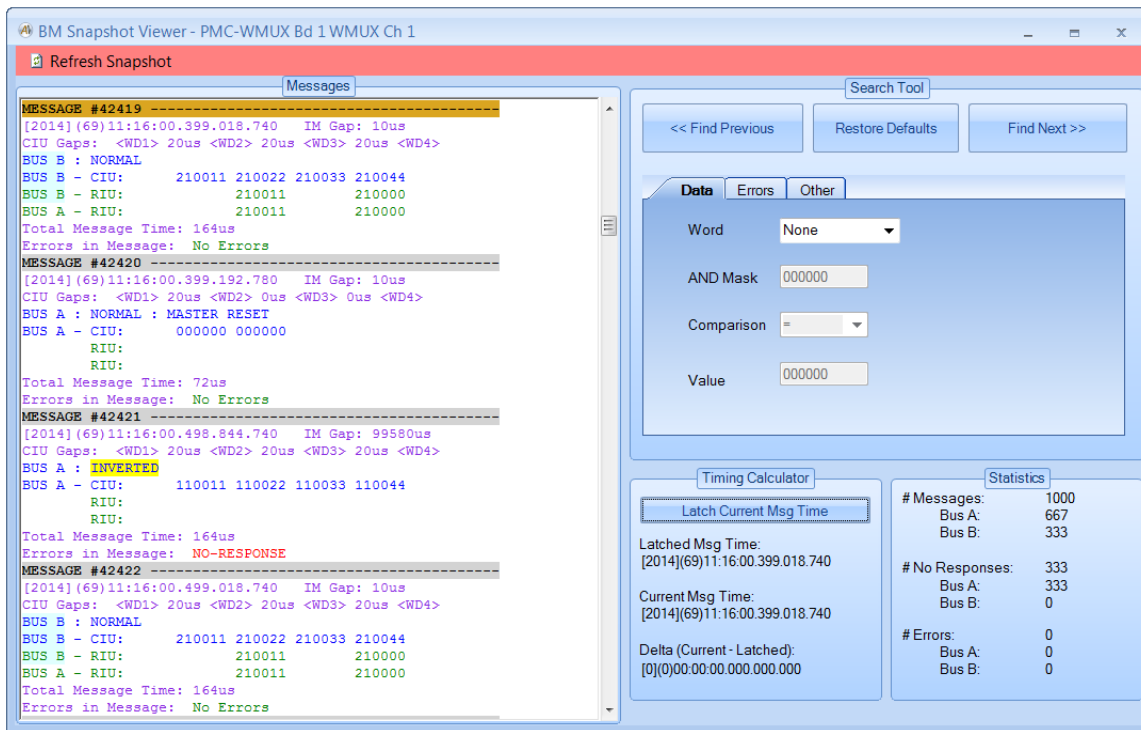

The Search Tool is a very powerful utility to find specific messages and conditions. This tool lets you specify search criterion in data words, errors, and/or a combination of them. You can search forward or backward from the current message.

If no message exists that meets the search criterion, then a message box will pop up to tell us that the message was not found.

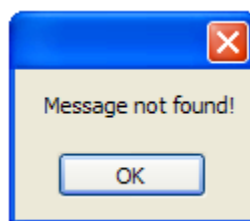

If we want to define a new search we can use the “Reset Defaults” button so we don’t have to remember and un-do the last set of search parameters. The default search settings will find any message.

Note that the last message found by the search tool is shown with a light blue background for the message number line in the message display.

BM Snapshot Viewer - PMC-WMUX Bd 1 WMUX Ch 1

Refresh Snapshot

Messages

```

MESSAGE #42422
[2014](69)11:16:00.499.018.740 IM Gap: 10us
CIU Gaps: <WD1> 20us <WD2> 20us <WD3> 20us <WD4>
BUS B : NORMAL
BUS B - CIU:      210011 210022 210033 210044
BUS B - RIU:      210011      210000
BUS A - RIU:      210011      210000
Total Message Time: 164us
Errors in Message: No Errors
-----
MESSAGE #42423
[2014](69)11:16:00.499.192.780 IM Gap: 10us
CIU Gaps: <WD1> 20us <WD2> 0us <WD3> 0us <WD4>
BUS A : NORMAL : MASTER RESET
BUS A - CIU:      000000 000000
RIU:
RIU:
Total Message Time: 72us
Errors in Message: No Errors
-----
MESSAGE #42424
[2014](69)11:16:00.598.844.740 IM Gap: 99580us
CIU Gaps: <WD1> 20us <WD2> 20us <WD3> 20us <WD4>
BUS A : INVERTED
BUS A - CIU:      110011 110022 110033 110044
RIU:
RIU:
Total Message Time: 164us
Errors in Message: NO-RESPONSE
-----
MESSAGE #42425
[2014](69)11:16:00.599.018.740 IM Gap: 10us
CIU Gaps: <WD1> 20us <WD2> 20us <WD3> 20us <WD4>
BUS B : NORMAL
BUS B - CIU:      210011 210022 210033 210044
BUS B - RIU:      210011      210000
BUS A - RIU:      210011      210000
Total Message Time: 164us
Errors in Message: No Errors

```

Search Tool

<< Find Previous Restore Defaults Find Next >>

Data Errors Other

Word: CIU Word 1

AND Mask: FF0000

Comparison: =

Value: 210000

Timing Calculator

Latch Current Msg Time

Latched Msg Time:
[2014](69)11:16:00.399.018.740

Current Msg Time:
[2014](69)11:16:00.499.018.740

Delta (Current - Latched):
000:00:00.100.000.000

Statistics

# Messages:	1000
Bus A:	667
Bus B:	333
# No Responses:	333
Bus A:	333
Bus B:	0
# Errors:	0
Bus A:	0
Bus B:	0

Statistics Tab

The “Statistics” tab provides detailed counters for messages, no-response, errors, etc. as shown below:

The screenshot shows the 'BM Control : PMC-WMUX Bd 1 WMUX Ch 1' window. The 'Statistics' tab is active. The 'Discovery' tree on the left shows a hierarchy: PMC-WMUX Bd 1 WMUX Ch 1 (Running) -> BUS A -> RIU 00 -> SA 00; RIU 01 -> SA 01; BUS B -> RIU 02 -> SA 01. The 'Statistics' panel is divided into three sections:

- Top Level:** Messages: 55818. Includes a 'Clear Counts' button.
- Bus B, RIU 02, SA 01:** Commands: 18606; No Response: 0; Errors: 0 (Bit Enc: 0, Parity: 0, Truncated: 0, Wrong RIU Resp: 0).
- Summary Information:** A table showing performance metrics.

Summary Information			
Msgs/Second	30	Messages	55818
		No Responses	18606
		Errors	0

The upper panel provides a top-level count of Messages. A “Clear Counts” button is provided here as well – this is identical to the “Clear Counts” button on the “Control” tab.

The lower panel is dependent upon the node selected in the discovery tree. In this case, we have selected the node for Bus B, RIU 02, SA 01 (by left-clicking on the node). The lower panel shows the message rate and count information for the selected level. If the top-level node for the channel is selected then the count information will apply to the entire channel.

Start BM

The “Start BM” button will start the Bus Monitor for the selected WMUX device. This button does not activate any other forms or windows.

Stop BM

The “Stop BM” button will stop the Bus Monitor for the selected WMUX device. This button does not activate any other forms or windows.

File Viewer

The “File Viewer” button will bring up the WMUX BM File Viewer window. Note that this control is not associated with a specific device and may be used even if no devices are open under *AltaView*.

The File Viewer is very similar to the Snapshot Viewer, but it operates on a saved file rather than on a memory snapshot.

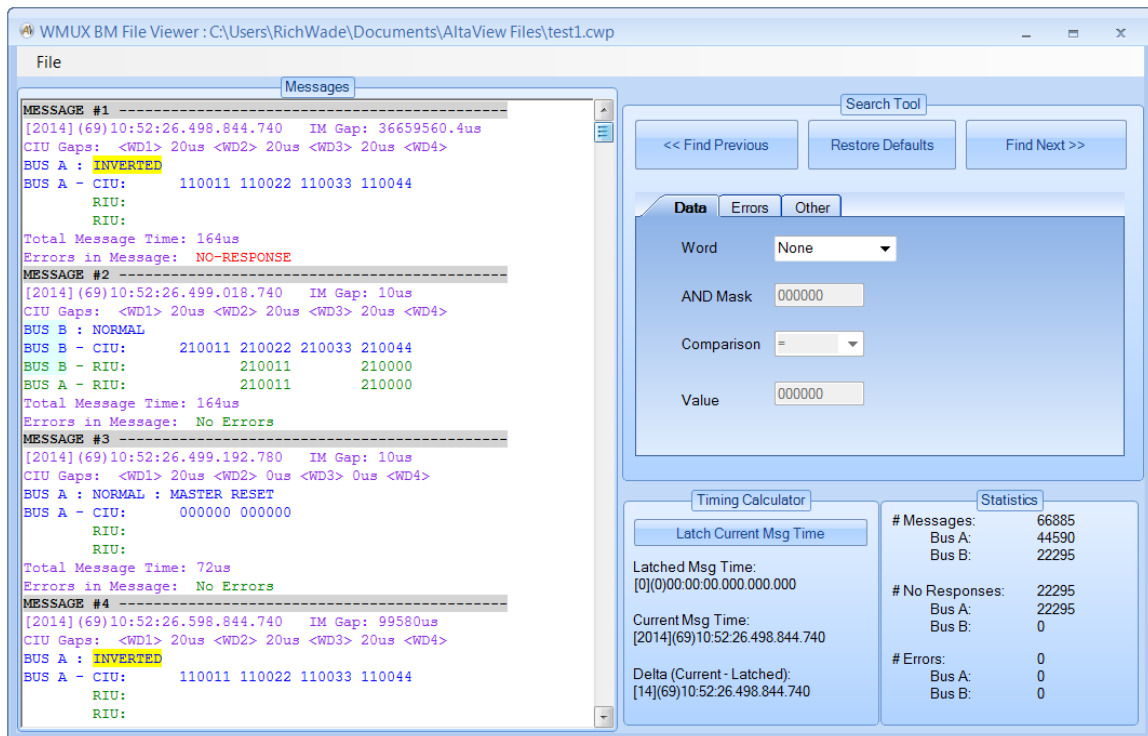

Note that the menu-strip provides a “File” option rather than the “Refresh Snapshot” option found in the Snapshot Viewer. Use the “File” menu to load a saved WMUX bus monitor file (“*.cwp*” file).

The Search Tool, Timing Calculator, and Statistics panel are identical to those found in the Snapshot Viewer.

RIU Tools

The RIU Tools provide controls for Remote Interface Unit operation.

RIU Control

The “RIU Control” button will bring up the RIU Control Panel for the selected WMUX device. This is the main window for all Remote Interface Unit operations for the device. ***If the device is not enabled for full analyzer operation, the Enable/Disable RIU and Error on Data features are disabled.***

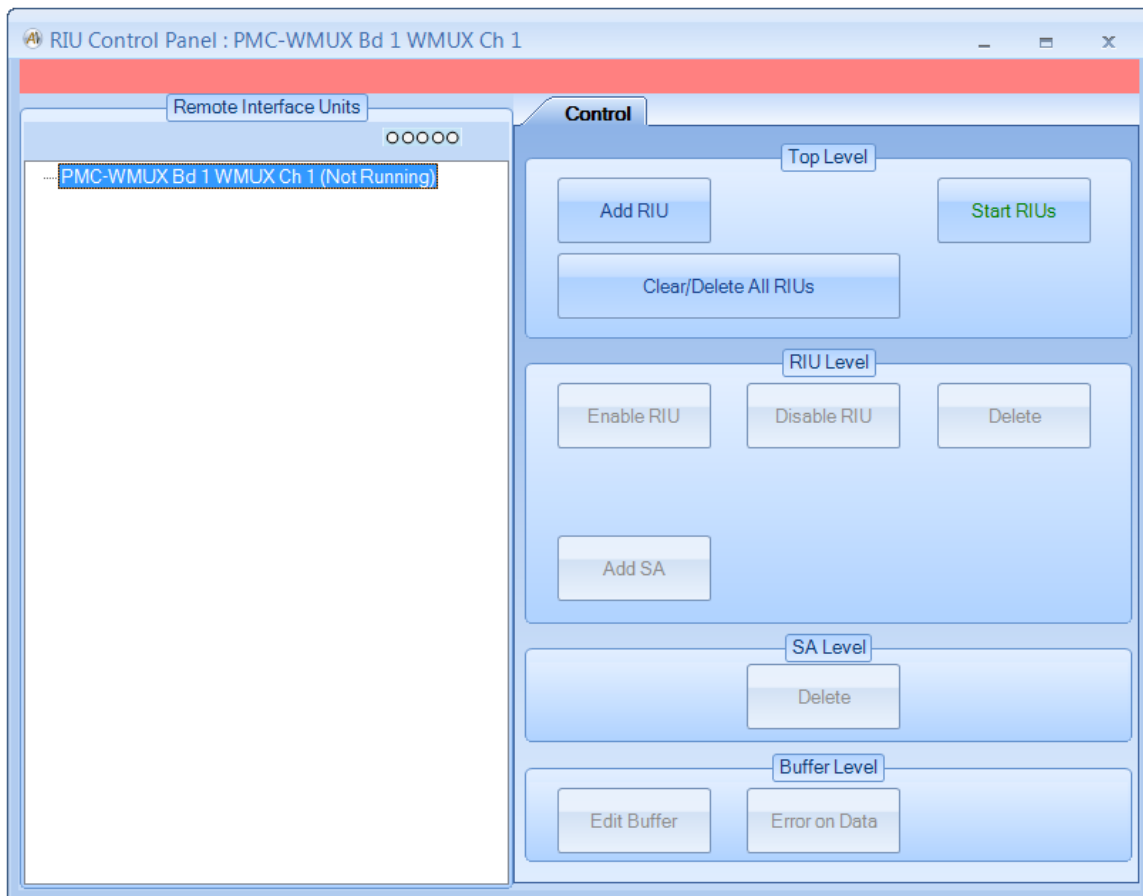

The RIU Control Panel provides both control buttons and context-menus. Right-click on a node in the RIU tree to bring up the appropriate context-menu for that node.

If no RIUs are defined, the tree will only show the top-level node for the device. You can add RIUs by right-clicking on the top-level node and selecting “Add RIU” (or by clicking the “Add RIU” button). This will bring up the “Add RIU” dialog box.

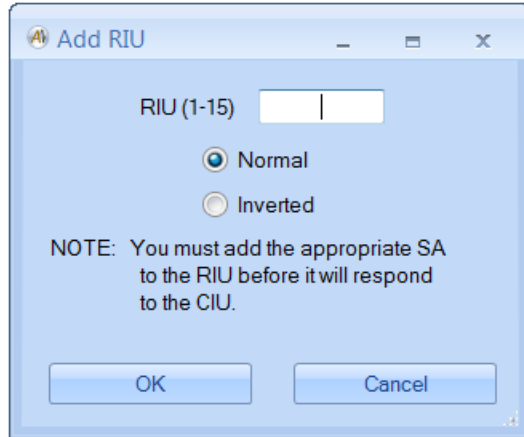

Enter the desired RIU address (1-15), select Normal or Inverted mode, and click on the “OK” button. This will create a RIU, but note that you will have to add the desired SA before the RIU will respond on the bus. Repeat this process to add more RIUs as needed.

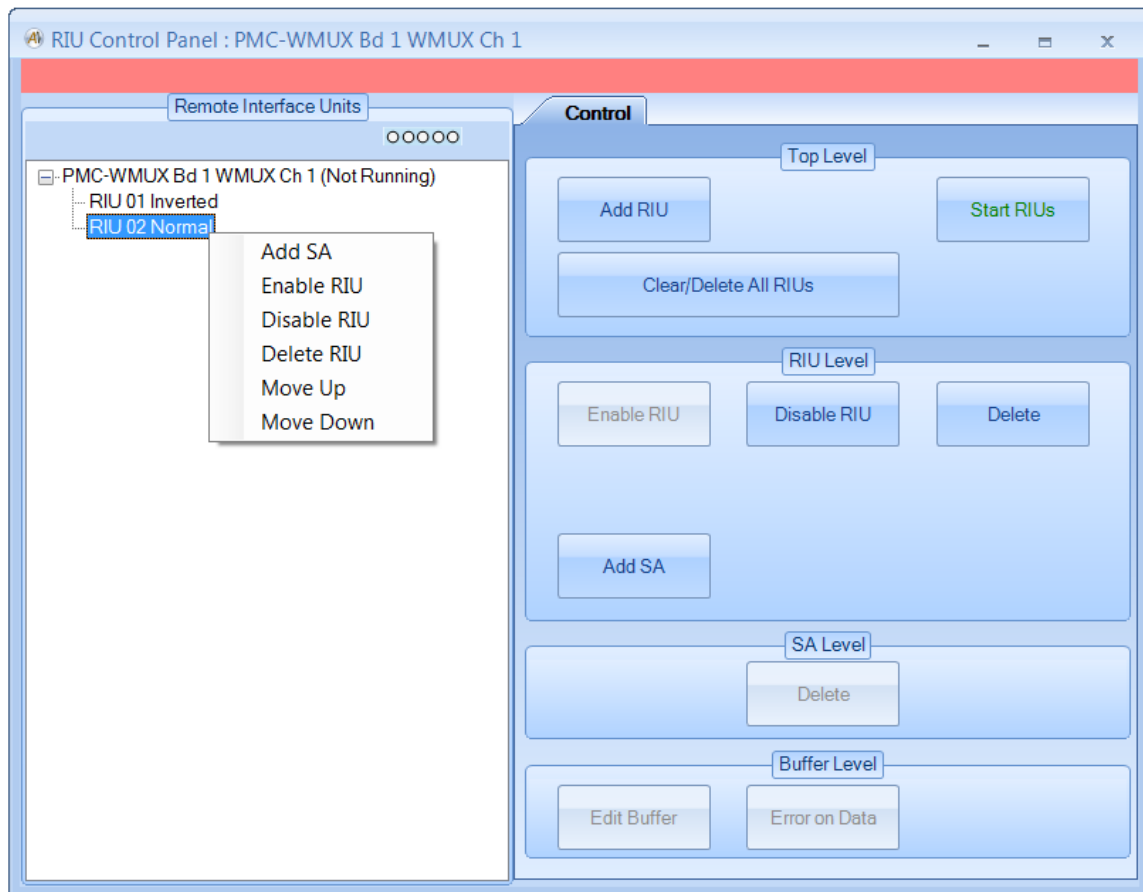

You can right-click on a RIU node to bring up a menu of RIU-level options. “Add SA” allocates buffers by subaddress. “Enable RIU” enables the RIU to respond on the bus (the RIU is enabled by default when it is added). “Disable RIU” disables the RIU so it will not respond on the bus (disabled RIUs will be shown in light gray). The “Delete RIU” option will remove the RIU from the tree and will free all resources associated with the RIU. The “Move Up” and “Move Down” options allow you to re-order the RIU nodes in the tree.

If you select “Add SA” you will see the following dialog-box:

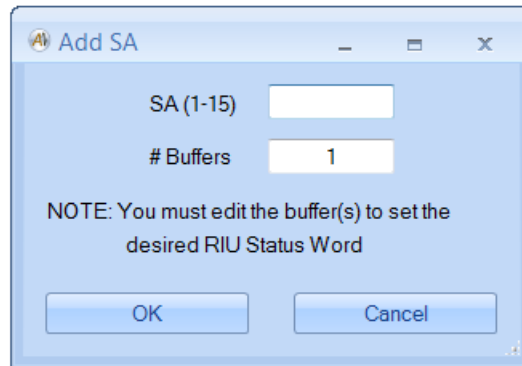

Select the subaddress number (1-15), and select the number of buffers to allocate for the SA – MOST APPLICATIONS ONLY USE ONE BUFFER, if you don’t have a reason to use multiple buffers then just use one. If more than one buffer is defined, they will be allocated as a circular linked-list – the buffers will be used in order and will start over with the first buffer when all buffers have been used.

After adding SA for the RIU, you will have SA and Buffer nodes in the RIU Control tree.

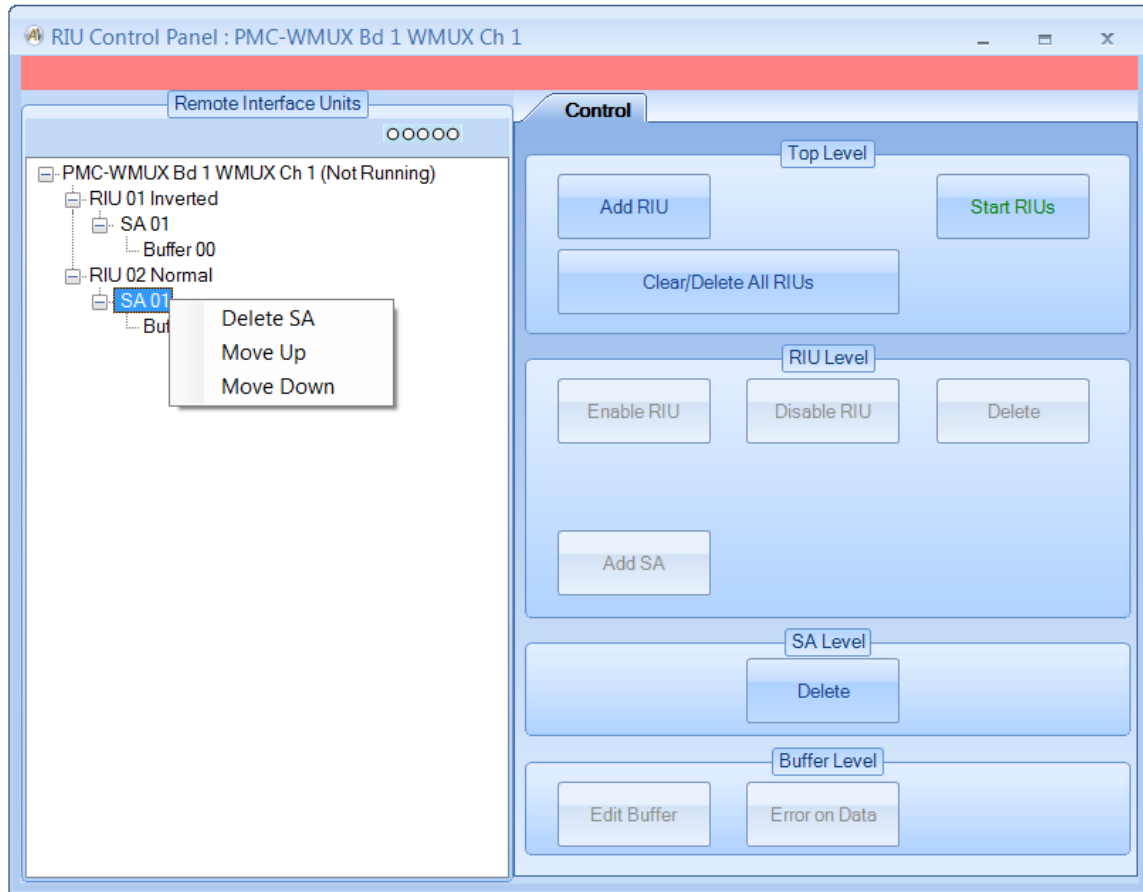

Right-clicking on a SA node will give you the options “Delete SA”, “Move Up”, and “Move Down”. “Delete SA” removes the SA from the tree and frees all resources associated with the SA. The “Move Up” and “Move Down” options allow you to reorder the SA nodes in the tree.

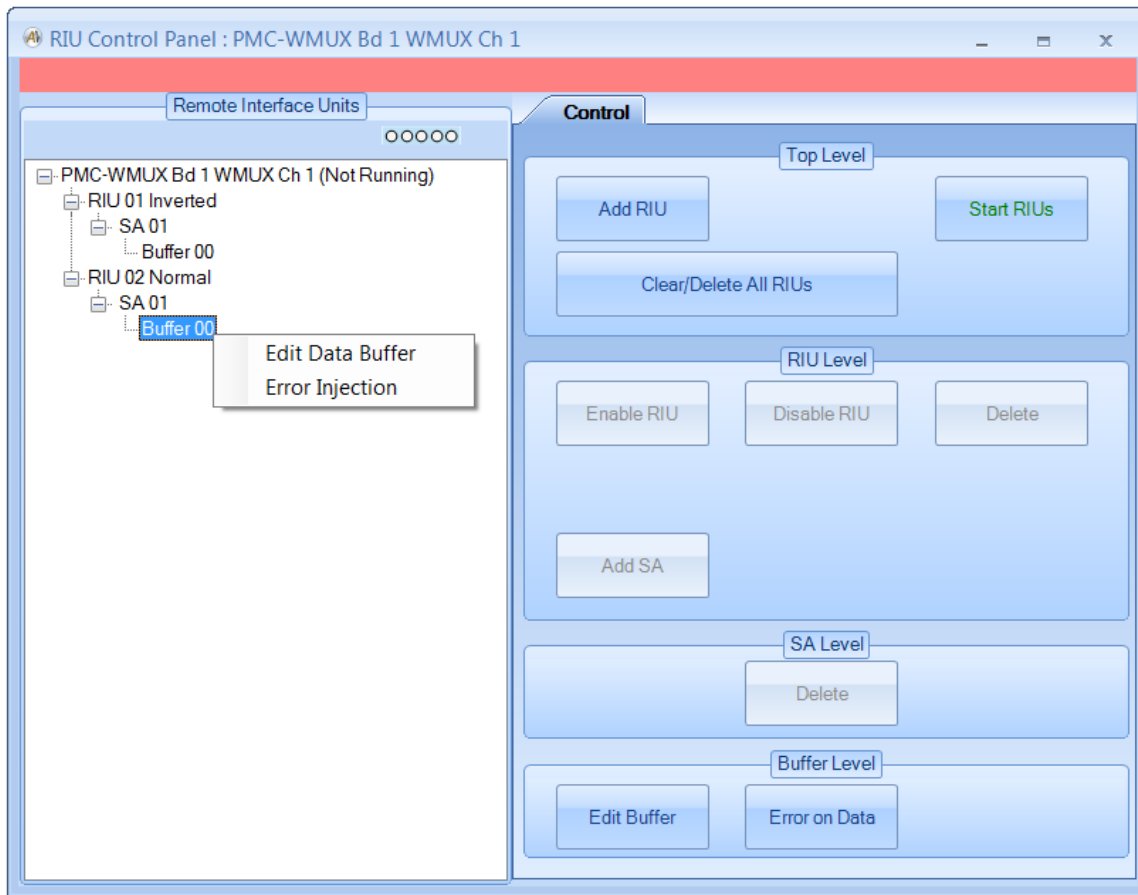

Right-clicking on a Buffer node will give you the options “Edit Data Buffer” and “Error Injection”. Double-clicking on a Buffer node will open the “Edit Data Buffer” dialog for that buffer.

If you select “Edit Data Buffer” this will bring up a dialog-box that displays the current RIU Status Word (RIU Word 2) in the buffer and gives you the option to change it. For RIU operation this is the only word you control.

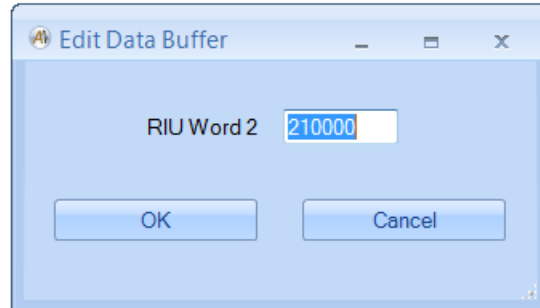

If you select “Error Injection” this will bring up a dialog-box that displays the current error injection settings for the buffer and gives you the option to modify them.

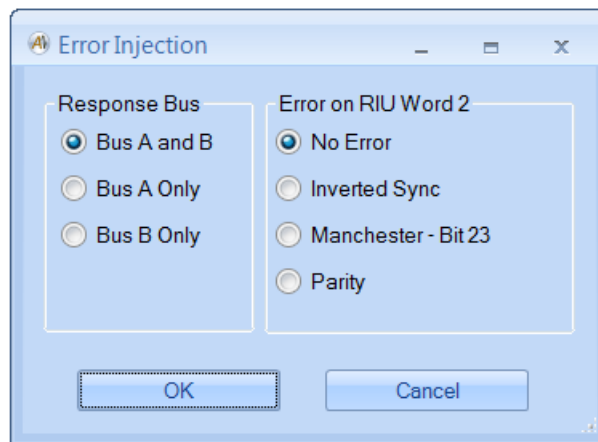

Start RIUs

The “Start RIUs” button will start RIU operation for the selected WMUX device. This button does not activate any other forms or windows.

Stop RIUs

The “Stop RIUs” button will stop RIU operation for the selected WMUX device. This button does not activate any other forms or windows.

CIU Tools

The CIU tools provide controls for Central Interface Unit operation. The WMUX CIU allocates memory on the device for a maximum of 1024 CIU messages.

CIU Control Panel

The “CIU Control” button will bring up the CIU Control Panel for the selected WMUX device. This is the main window for all CIU operations for the device. ***If the device is not enabled for full analyzer operation, the Message Enable/Disable, Trigger In/Out, and Error on Data features are disabled.***

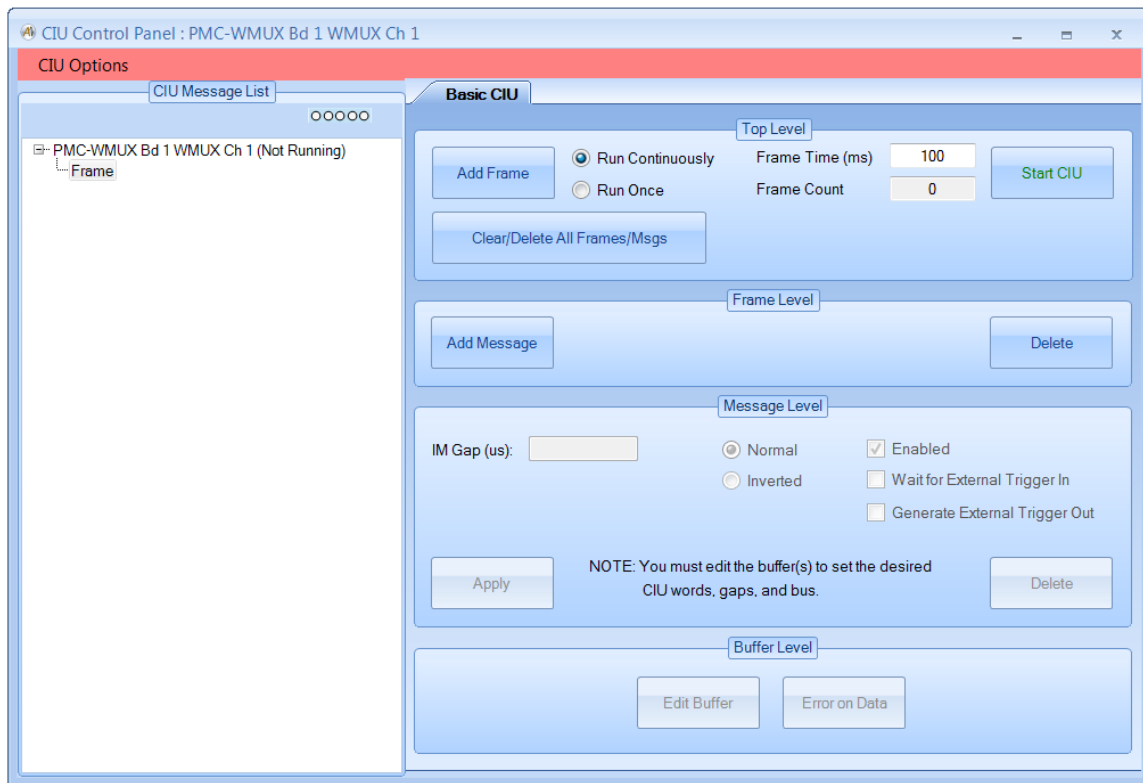

The “CIU Options” menu-strip selection allows you to enable the CIU to automatically send a Master Reset message when certain conditions occur. You can enable MR on No Response, MR on Echo Mismatch, and MR on RIU Protocol Error.

The CIU Control Panel provides a tree-view on the left that displays the CIU message list. Controls are provided on the right. The controls are organized by functional level – top level, frame level, message level, and buffer level.

When the CIU Control Panel is opened with no CIU message list defined, **AltaView** automatically creates an empty Frame node for you. If you click on this frame node the frame-level controls will be enabled. You can use the frame-level buttons to add messages to the frame.

When you click the button to “Add Message” you will see the following dialog box:

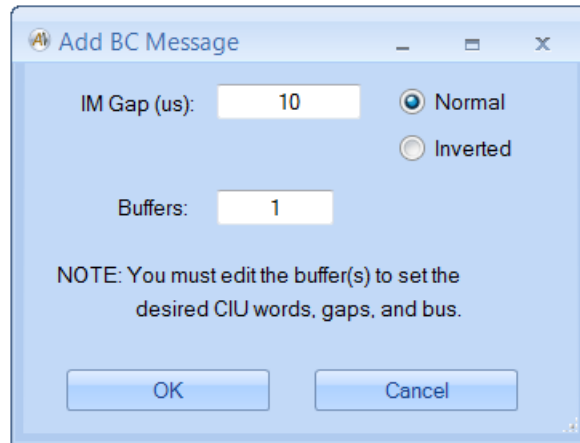

At this point you define the intermessage gap (time from end of previous message), specify if the message is Normal or Inverted mode, and select the number of buffers. Note that most applications only use one buffer per message. The actual CIU words for the message will be defined in the buffer.

Once you have created messages, the tree will show frames, messages, and buffers. Clicking on a node in the tree enables the appropriate buttons on the right side of the CIU Control Panel.

CIU Control Panel – Basic CIU – Top Level

The following shows what the CIU Control Panel looks like at the top level:

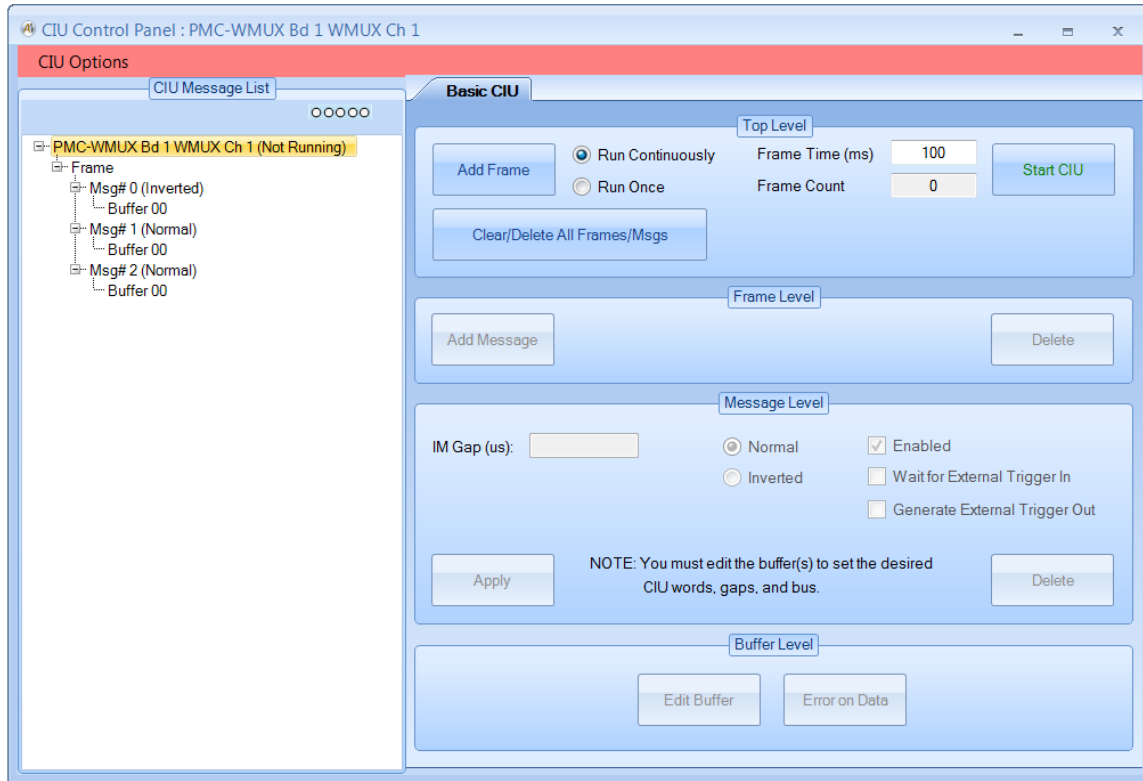

The top level controls allow you to configure the CIU to run continuously or run once, set the frame time, add frames to the CIU list, and start or stop the CIU. The frame time can be a real number rather than an integer – for example, you can set a frame time of 12.5 milliseconds to get an 80 Hz frame rate. If “run continuously” is selected the CIU will run the list repeatedly until stopped. If “run once” is selected, the CIU list will be sent once and the CIU will stop. The frame time is in units of milliseconds. When the CIU is running the “Frame Count” will show the number of frames that have been executed.

The “Clear/Delete All Frames/Msgs” button clears the BC message list. This button completely resets the Bus Controller object.

CIU Control Panel – Basic CIU – Frame Level

If a frame node is selected, the frame level controls will be enabled.

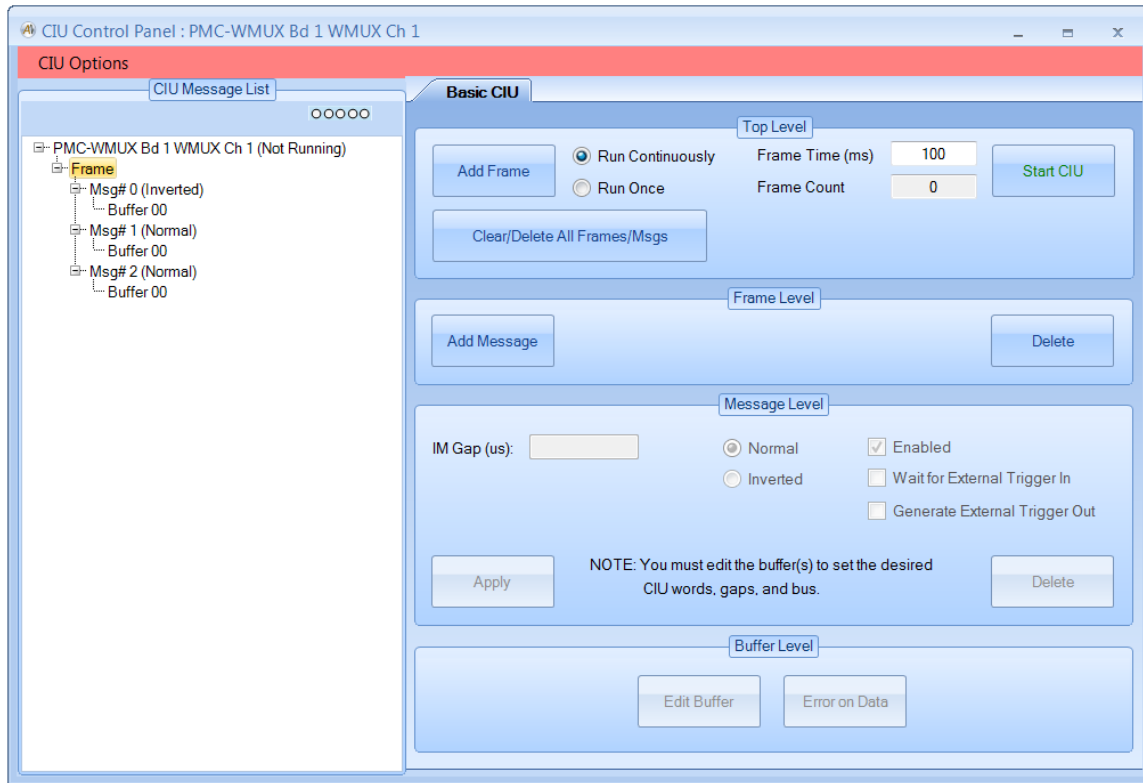

The frame level controls allow you to add messages to the frame or to delete the selected frame.

CIU Control Panel – Basic CIU – Message Level

If a message node is selected, the message level controls will be enabled.

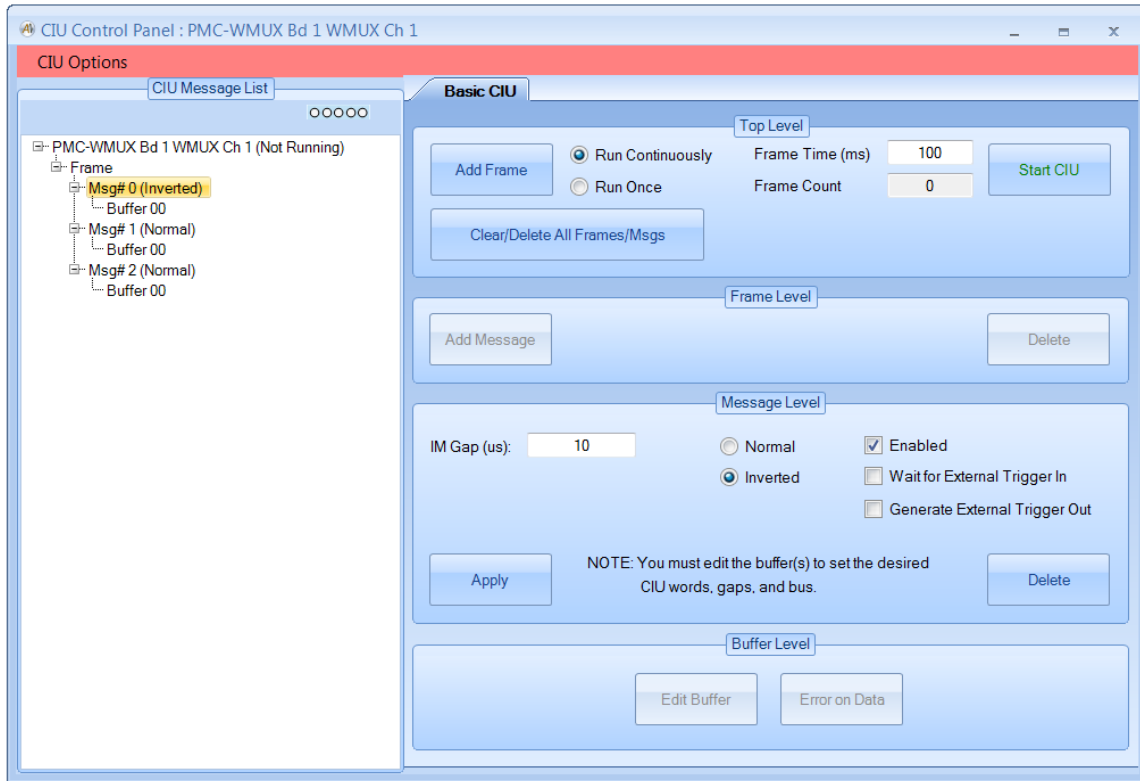

The message level controls allow you to edit or delete the selected message. ***If you edit the message, your changes do not take effect unless you click the “Apply” button.***

CIU Control Panel – Basic CIU – Buffer Level

If a buffer node is selected, the buffer level controls will be enabled.

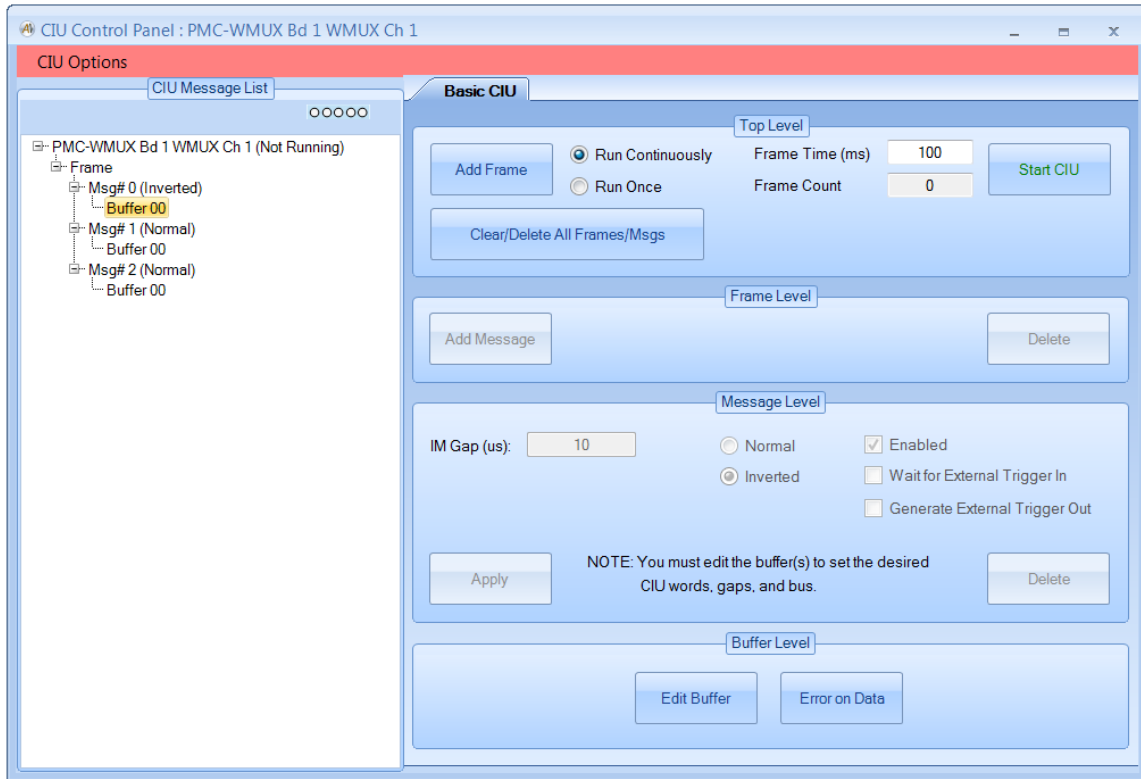

The buffer level controls allow you to edit the selected buffer and inject errors in the buffer. Double-clicking on a Buffer node will open the “Edit Data Buffer” dialog for that buffer.

If you click on the “Edit Buffer” button you will see the following dialog box:

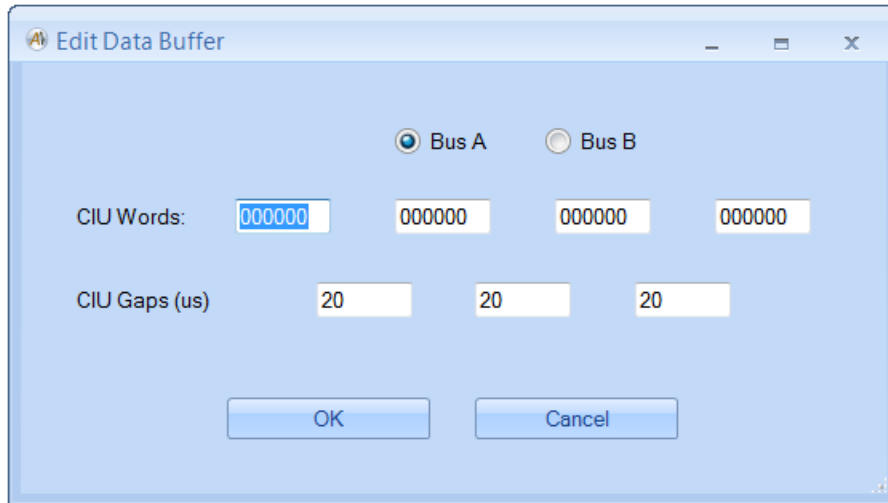

This allows you to select the bus that the message will be sent on and change the CIU word values. The values are in hexadecimal format. The words are 24-bits (6 hex digits). The two high nibbles are the RT address and sub address, the remaining 16-bits are for data. YOU SHOULD SET RT AND SA IN ALL WORDS. For example, if this message is intended for RT 2, SA1 the high two nibbles should be 21 for all words, so we would have four CIU words like this:

210011 210022 210033 210044

You can also change the gap times between CIU words (maximum 6500us).

Note that RT 0 is reserved for MASTER RESET. If CIU word 1 specifies RT 0, the CIU will treat this as a MASTER RESET message and will send only two words.

If you click on the “Error on Data” button you will see the following dialog box:

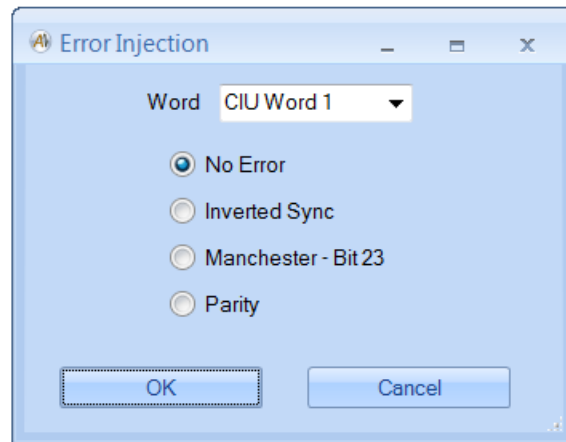

This is similar to the Error Injection dialog box used with RIU buffers. Select the desired CIU word and select the error type.

Start CIU

The “Start CIU” button will start the CIU for the selected WMUX device. This button does not activate any other forms or windows.

Stop CIU

The “Stop CIU” button will stop the CIU for the selected WMUX device. This button does not activate any other forms or windows.

Appendix A – System Requirements

The minimum system requirements for *AltaView* are listed below:

Hardware:

- Computer with a 1.6 GHz or faster processor
- 1024 MB or more of RAM
- 3 GB or more of available hard-disk space
- 1024x768 or higher-resolution display with 256 colors, Direct-X 9 capable
- Keyboard and Microsoft Mouse or compatible pointing device

Architecture:

- 32-bit (x86) or 64-bit (x64)

Operating System:

- Microsoft® Windows 7™
- Microsoft® Windows 10™
- Microsoft® Windows Server™ 2008 with Service Pack 2
- Microsoft® Windows Server™ 2008 R2

Other:

- Microsoft® .NET Framework version 3.5
- Adobe® Reader (for PDF documentation)

NOTE FOR WINDOWS 7:

The “Aero” or “Glass Effect” features in Windows Windows 7 require significant graphics processing and can cause significant “flicker” in *AltaView* when the screen updates things like the BM Discovery tree-view. This can be improved by selecting a non-Aero Theme (Windows 7 Basic or Windows Classic).

Basic and High Contrast Themes (6)



Appendix B – XML Configuration Files

AltaView uses the XML (eXtensible Markup Language) file format to save/load configuration information. XML files are relatively easy to work with and can be edited with simple text editors.

AltaView will load the “AV_Default.xml” configuration file on startup. You can save the default settings from **AltaView** by selecting the “Save as Default Configuration” option under the Logo-Button menu.

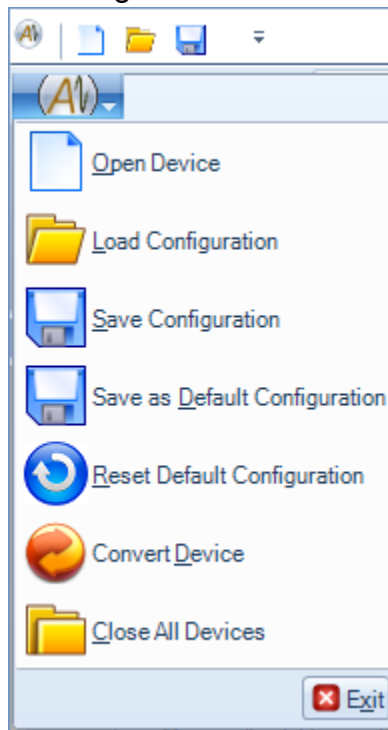

You can save configurations to files other than “AV_Default.xml” using the “Save Configuration” option under the Logo-Button menu – this allows you to specify the filename for your configuration file.

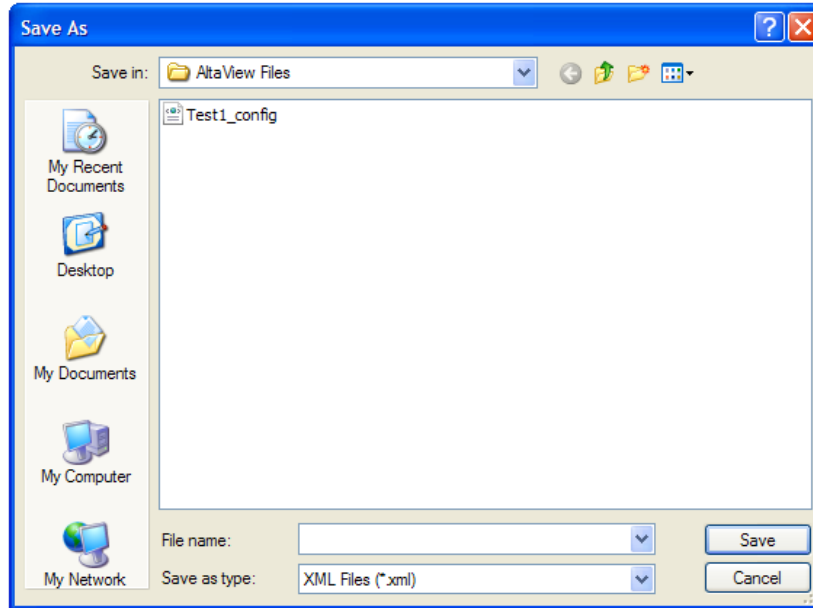

An XML schema (.xsd) file defines the expected format, required fields, etc. for an XML file. *AltaView* configuration files are validated using the schema file “AV_Configuration.xsd” when they are loaded. If an XML configuration file fails validation *AltaView* will display an appropriate error message. For example, when we deliberately change the XML file to contain an invalid attribute then try to open the configuration file from *AltaView*, we see something like this:

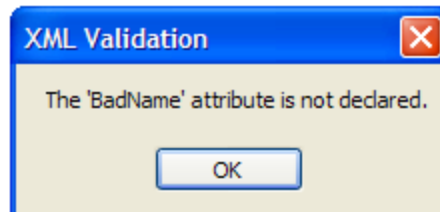

1553 Configuration File

A sample *AltaView* XML configuration file for 1553 is provided here:

```
<?xml version="1.0" encoding="utf-16"?>
<!--XML File for AltaView Settings-->
<AV_Configuration AV_Version="0.0.7.7">
  <Device DevID="00000000" DevName="TEST-1553 Bd 1 Ch 1" Remote="false"
  ipAddr="192.168.0.5" tcpPort="8086">
    <!--User-Defined Names-->
    <AV_User_Defined_Names>
      <RT_Name RT="1">ECU</RT_Name>
      <SA_Name RT="1" TR="0" SA="0">1R0</SA_Name>
      <SA_Name RT="1" TR="0" SA="1">1R1</SA_Name>
    </AV_User_Defined_Names>
  </Device>
</AV_Configuration>
```



```

<SA_Name RT="1" TR="0" SA="3">1R3</SA_Name>
<RT_Name RT="2">RADAR</RT_Name>
<SA_Name RT="2" TR="1" SA="2">2T2</SA_Name>
<SA_Name RT="2" TR="1" SA="3">2T3</SA_Name>
<RT_Name RT="31">BROADCAST</RT_Name>
<SA_Name RT="31" TR="0" SA="0">31R0</SA_Name>
<SA_Name RT="31" TR="0" SA="2">31R2</SA_Name>
<SA_Name RT="31" TR="0" SA="3">31R3</SA_Name>
</AV_User_Defined_Names>
<!--1553 Device Settings-->
<M1553>
  <!--1553 Options-->
  <M1553_Options isMRT="true" IntBus="false" is1553B="true" isRT31Bcast="true"
statusTimeout="12" />
  <!--Bus Monitor-->
  <BM>
    <M1553_BM_InitAction Run="false" />
    <M1553_BM_Log Enabled="false" Filename="AV_BMlog.cdp" IncrFileName="false" />
    <M1553_BM_Frame Enabled="false" CMDword="F811" />
    <M1553_BM_Filter RT="0" RxFilters="FFFFFFFF" TxFilters="FFFFFFFF" />
    <M1553_BM_Filter RT="1" RxFilters="FFFFFFFF" TxFilters="FFFFFFFF" />
    <M1553_BM_Filter RT="2" RxFilters="FFFFFFFF" TxFilters="FFFFFFFF" />
    <M1553_BM_Filter RT="3" RxFilters="FFFFFFFF" TxFilters="FFFFFFFF" />
    <M1553_BM_Filter RT="4" RxFilters="FFFFFFFF" TxFilters="FFFFFFFF" />
    <M1553_BM_Filter RT="5" RxFilters="00000000" TxFilters="00000000" />
    <M1553_BM_Filter RT="6" RxFilters="FFFFFFFF" TxFilters="FFFFFFFF" />
    <M1553_BM_Filter RT="7" RxFilters="00000000" TxFilters="00000000" />
    <M1553_BM_Filter RT="8" RxFilters="FFFFFFFF" TxFilters="FFFFFFFF" />
    <M1553_BM_Filter RT="9" RxFilters="FFFFFFFF" TxFilters="FFFFFFFF" />
    <M1553_BM_Filter RT="10" RxFilters="FFFFFFFF" TxFilters="FFFFFFFF" />
    <M1553_BM_Filter RT="11" RxFilters="FFFFFFFF" TxFilters="FFFFFFFF" />
    <M1553_BM_Filter RT="12" RxFilters="FFFFFFFF" TxFilters="FFFFFFFF" />
    <M1553_BM_Filter RT="13" RxFilters="FFFFFFFF" TxFilters="FFFFFFFF" />
    <M1553_BM_Filter RT="14" RxFilters="FFFFFFFF" TxFilters="FFFFFFFF" />
    <M1553_BM_Filter RT="15" RxFilters="FFFFFFFF" TxFilters="FFFFFFFF" />
    <M1553_BM_Filter RT="16" RxFilters="FFFFFFFF" TxFilters="FFFFFFFF" />
    <M1553_BM_Filter RT="17" RxFilters="FFFFFFFF" TxFilters="FFFFFFFF" />
    <M1553_BM_Filter RT="18" RxFilters="FFFFFFFF" TxFilters="FFFFFFFF" />
    <M1553_BM_Filter RT="19" RxFilters="FFFFFFFF" TxFilters="FFFFFFFF" />
    <M1553_BM_Filter RT="20" RxFilters="FFFFFFFF" TxFilters="FFFFFFFF" />
    <M1553_BM_Filter RT="21" RxFilters="FFFFFFFF" TxFilters="FFFFFFFF" />
    <M1553_BM_Filter RT="22" RxFilters="FFFFFFFF" TxFilters="FFFFFFFF" />
    <M1553_BM_Filter RT="23" RxFilters="FFFFFFFF" TxFilters="FFFFFFFF" />
    <M1553_BM_Filter RT="24" RxFilters="FFFFFFFF" TxFilters="FFFFFFFF" />
    <M1553_BM_Filter RT="25" RxFilters="FFFFFFFF" TxFilters="FFFFFFFF" />
    <M1553_BM_Filter RT="26" RxFilters="FFFFFFFF" TxFilters="FFFFFFFF" />
    <M1553_BM_Filter RT="27" RxFilters="FFFFFFFF" TxFilters="FFFFFFFF" />
    <M1553_BM_Filter RT="28" RxFilters="FFFFFFFF" TxFilters="FFFFFFFF" />
    <M1553_BM_Filter RT="29" RxFilters="FFFFFFFF" TxFilters="FFFFFFFF" />
    <M1553_BM_Filter RT="30" RxFilters="FFFFFFFF" TxFilters="FFFFFFFF" />
    <M1553_BM_Filter RT="31" RxFilters="FFFFFFFF" TxFilters="FFFFFFFF" />
  </BM>
  <!--Remote Terminal-->
  <RT>
    <M1553_RT RT="1" Enabled="true" Status_Word="0800" Response_Time="40"
StsSyncErr="false" StsManchesterErr="false" StsParityErr="false">
      <M1553_RT_SA TR="0" SA="1" NumBuffers="1" LegalWC="00000000">
        <M1553_RT_SA_Buffer BuffNum="0" CDPcontrol="3F000000" DATA0="00000000"
DATA01="00000000" DATA02="00000000" DATA03="00000000" DATA04="00000000" DATA05="00000000"
DATA06="00000000" DATA07="00000000" DATA08="00000000" DATA09="00000000" DATA10="00000000"
DATA11="00000000" DATA12="00000000" DATA13="00000000" DATA14="00000000" DATA15="00000000"
DATA16="00000000" DATA17="00000000" DATA18="00000000" DATA19="00000000" DATA20="00000000"

```

```

DATA21="00000000" DATA22="00000000" DATA23="00000000" DATA24="00000000" DATA25="00000000"
DATA26="00000000" DATA27="00000000" DATA28="00000000" DATA29="00000000" DATA30="00000000"
DATA31="00000000" />
</M1553_RT_SA>
</M1553_RT>
<M1553_RT RT="2" Enabled="true" Status_Word="1000" Response_Time="40"
StsSyncErr="false" StsManchesterErr="false" StsParityErr="false">
  <M1553_RT_MC TR="0" MC="17" NumBuffers="1" LegalMC="00000000">
    <M1553_RT_MC_Buffer BuffNum="0" CDPcontrol="3F000000" DATA00="00000000"
DATA01="00000000" DATA02="00000000" DATA03="00000000" DATA04="00000000" DATA05="00000000"
DATA06="00000000" DATA07="00000000" DATA08="00000000" DATA09="00000000" DATA10="00000000"
DATA11="00000000" DATA12="00000000" DATA13="00000000" DATA14="00000000" DATA15="00000000"
DATA16="00000000" DATA17="00000000" DATA18="00000000" DATA19="00000000" DATA20="00000000"
DATA21="00000000" DATA22="00000000" DATA23="00000000" DATA24="00000000" DATA25="00000000"
DATA26="00000000" DATA27="00000000" DATA28="00000000" DATA29="00000000" DATA30="00000000"
DATA31="00000000" />
    </M1553_RT_MC>
    <M1553_RT_MC TR="1" MC="7" NumBuffers="1" LegalMC="00000000">
      <M1553_RT_MC_Buffer BuffNum="0" CDPcontrol="3F000000" DATA00="00000000"
DATA01="00000000" DATA02="00000000" DATA03="00000000" DATA04="00000000" DATA05="00000000"
DATA06="00000000" DATA07="00000000" DATA08="00000000" DATA09="00000000" DATA10="00000000"
DATA11="00000000" DATA12="00000000" DATA13="00000000" DATA14="00000000" DATA15="00000000"
DATA16="00000000" DATA17="00000000" DATA18="00000000" DATA19="00000000" DATA20="00000000"
DATA21="00000000" DATA22="00000000" DATA23="00000000" DATA24="00000000" DATA25="00000000"
DATA26="00000000" DATA27="00000000" DATA28="00000000" DATA29="00000000" DATA30="00000000"
DATA31="00000000" />
      </M1553_RT_MC>
    </M1553_RT>
    <M1553_RT RT="3" Enabled="true" Status_Word="1A00" Response_Time="80"
StsSyncErr="false" StsManchesterErr="false" StsParityErr="false">
      <M1553_RT_SA TR="1" SA="2" NumBuffers="2" LegalWC="00000000">
        <M1553_RT_SA_Buffer BuffNum="0" CDPcontrol="3F000000" DATA00="00000000"
DATA01="00000000" DATA02="00000000" DATA03="00000000" DATA04="00000000" DATA05="00000000"
DATA06="00000000" DATA07="00000000" DATA08="00000000" DATA09="00000000" DATA10="00000000"
DATA11="00000000" DATA12="00000000" DATA13="00000000" DATA14="00000000" DATA15="00000000"
DATA16="00000000" DATA17="00000000" DATA18="00000000" DATA19="00000000" DATA20="00000000"
DATA21="00000000" DATA22="00000000" DATA23="00000000" DATA24="00000000" DATA25="00000000"
DATA26="00000000" DATA27="00000000" DATA28="00000000" DATA29="00000000" DATA30="00000000"
DATA31="00000000" />
        <M1553_RT_SA_Buffer BuffNum="1" CDPcontrol="3F000000" DATA00="00000000"
DATA01="00000000" DATA02="00000000" DATA03="00000000" DATA04="00000000" DATA05="00000000"
DATA06="00000000" DATA07="00000000" DATA08="00000000" DATA09="00000000" DATA10="00000000"
DATA11="00000000" DATA12="00000000" DATA13="00000000" DATA14="00000000" DATA15="00000000"
DATA16="00000000" DATA17="00000000" DATA18="00000000" DATA19="00000000" DATA20="00000000"
DATA21="00000000" DATA22="00000000" DATA23="00000000" DATA24="00000000" DATA25="00000000"
DATA26="00000000" DATA27="00000000" DATA28="00000000" DATA29="00000000" DATA30="00000000"
DATA31="00000000" />
        </M1553_RT_SA>
      </M1553_RT>
      <M1553_RT RT="4" Enabled="true" Status_Word="2000" Response_Time="40"
StsSyncErr="false" StsManchesterErr="false" StsParityErr="false" />
    </RT>
  <!--Bus Controller-->
  <BC>
    <M1553_BC FrameTime="100" RunContinuously="true">
      <M1553_BC_CB CSR="04000006" CMD1="00000820" CMD2="00000000" FrmTime="1000000"
GapTime="80" NumBufs="1" Cmd1SyncErr="false" Cmd1ManchesterErr="false"
Cmd1ParityErr="false" Cmd2SyncErr="false" Cmd2ManchesterErr="false"
Cmd2ParityErr="false">
        <M1553_BC_Buffer BuffNum="0" CDPcontrol="3F000000" DATA00="00000000"
DATA01="00000000" DATA02="00000000" DATA03="00000000" DATA04="00000000" DATA05="00000000"
DATA06="00000000" DATA07="00000000" DATA08="00000000" DATA09="00000000" DATA10="00000000"

```

```

DATA11="00000000" DATA12="00000000" DATA13="00000000" DATA14="00000000" DATA15="00000000"
DATA16="00000000" DATA17="00000000" DATA18="00000000" DATA19="00000000" DATA20="00000000"
DATA21="00000000" DATA22="00000000" DATA23="00000000" DATA24="00000000" DATA25="00000000"
DATA26="00000000" DATA27="00000000" DATA28="00000000" DATA29="00000000" DATA30="00000000"
DATA31="00000000" />
  </M1553_BC_CB>
  <M1553_BC_CB CSR="4000000A" CMD1="00000402" CMD2="00000000" FrmTime="1000000"
GapTime="80" NumBufs="1" Cmd1SyncErr="false" Cmd1ManchesterErr="false"
Cmd1ParityErr="false" Cmd2SyncErr="false" Cmd2ManchesterErr="false"
Cmd2ParityErr="false">
    <M1553_BC_Buffer Buffer BuffNum="0" CDPcontrol="3F000000" DATA00="00000000"
DATA01="00000000" DATA02="00000000" DATA03="00000000" DATA04="00000000" DATA05="00000000"
DATA06="00000000" DATA07="00000000" DATA08="00000000" DATA09="00000000" DATA10="00000000"
DATA11="00000000" DATA12="00000000" DATA13="00000000" DATA14="00000000" DATA15="00000000"
DATA16="00000000" DATA17="00000000" DATA18="00000000" DATA19="00000000" DATA20="00000000"
DATA21="00000000" DATA22="00000000" DATA23="00000000" DATA24="00000000" DATA25="00000000"
DATA26="00000000" DATA27="00000000" DATA28="00000000" DATA29="00000000" DATA30="00000000"
DATA31="00000000" />
  </M1553_BC_CB>
</M1553_BC>
</BC>
</M1553>
</Device>

<Device DevID="00000001" DevName="TEST-1553 Bd 1 Ch 2" Remote="false"
ipAddr="192.168.0.5" tcpPort="8086">
  <!--User-Defined Names-->
  <AV_User_Defined_Names />
  <!--1553 Device Settings-->
  <M1553>
    <!--1553 Options-->
    <M1553_Options isMRT="true" IntBus="false" is1553B="true" isRT31Bcast="true"
statusTimeout="12" />
    <!--Bus Monitor-->
    <BM>
      <M1553_BM_InitAction Run="false" />
      <M1553_BM_Log Enabled="false" Filename="AV_BMlog.cdp" IncrFileName="false" />
      <M1553_BM_Frame Enabled="false" CMDword="F811" />
      <M1553_BM_Filter RT="0" RxFilters="FFFFFFFF" TxFilters="FFFFFFFF" />
      <M1553_BM_Filter RT="1" RxFilters="FFFFFFFF" TxFilters="FFFFFFFF" />
      <M1553_BM_Filter RT="2" RxFilters="FFFFFFFF" TxFilters="FFFFFFFF" />
      <M1553_BM_Filter RT="3" RxFilters="FFFFFFFF" TxFilters="FFFFFFFF" />
      <M1553_BM_Filter RT="4" RxFilters="FFFFFFFF" TxFilters="FFFFFFFF" />
      <M1553_BM_Filter RT="5" RxFilters="FFFFFFFF" TxFilters="FFFFFFFF" />
      <M1553_BM_Filter RT="6" RxFilters="FFFFFFFF" TxFilters="FFFFFFFF" />
      <M1553_BM_Filter RT="7" RxFilters="FFFFFFFF" TxFilters="FFFFFFFF" />
      <M1553_BM_Filter RT="8" RxFilters="FFFFFFFF" TxFilters="FFFFFFFF" />
      <M1553_BM_Filter RT="9" RxFilters="FFFFFFFF" TxFilters="FFFFFFFF" />
      <M1553_BM_Filter RT="10" RxFilters="FFFFFFFF" TxFilters="FFFFFFFF" />
      <M1553_BM_Filter RT="11" RxFilters="FFFFFFFF" TxFilters="FFFFFFFF" />
      <M1553_BM_Filter RT="12" RxFilters="FFFFFFFF" TxFilters="FFFFFFFF" />
      <M1553_BM_Filter RT="13" RxFilters="FFFFFFFF" TxFilters="FFFFFFFF" />
      <M1553_BM_Filter RT="14" RxFilters="FFFFFFFF" TxFilters="FFFFFFFF" />
      <M1553_BM_Filter RT="15" RxFilters="FFFFFFFF" TxFilters="FFFFFFFF" />
      <M1553_BM_Filter RT="16" RxFilters="FFFFFFFF" TxFilters="FFFFFFFF" />
      <M1553_BM_Filter RT="17" RxFilters="FFFFFFFF" TxFilters="FFFFFFFF" />
      <M1553_BM_Filter RT="18" RxFilters="FFFFFFFF" TxFilters="FFFFFFFF" />
      <M1553_BM_Filter RT="19" RxFilters="FFFFFFFF" TxFilters="FFFFFFFF" />
      <M1553_BM_Filter RT="20" RxFilters="FFFFFFFF" TxFilters="FFFFFFFF" />
      <M1553_BM_Filter RT="21" RxFilters="FFFFFFFF" TxFilters="FFFFFFFF" />
      <M1553_BM_Filter RT="22" RxFilters="FFFFFFFF" TxFilters="FFFFFFFF" />
      <M1553_BM_Filter RT="23" RxFilters="FFFFFFFF" TxFilters="FFFFFFFF" />
    </BM>
  </M1553>
</Device>

```

```
<M1553_BM_Filter RT="24" RxFilters="FFFFFFFF" TxFilters="FFFFFFFF" />
<M1553_BM_Filter RT="25" RxFilters="FFFFFFFF" TxFilters="FFFFFFFF" />
<M1553_BM_Filter RT="26" RxFilters="FFFFFFFF" TxFilters="FFFFFFFF" />
<M1553_BM_Filter RT="27" RxFilters="FFFFFFFF" TxFilters="FFFFFFFF" />
<M1553_BM_Filter RT="28" RxFilters="FFFFFFFF" TxFilters="FFFFFFFF" />
<M1553_BM_Filter RT="29" RxFilters="FFFFFFFF" TxFilters="FFFFFFFF" />
<M1553_BM_Filter RT="30" RxFilters="FFFFFFFF" TxFilters="FFFFFFFF" />
<M1553_BM_Filter RT="31" RxFilters="FFFFFFFF" TxFilters="FFFFFFFF" />
</BM>
<!--Remote Terminal-->
<RT />
<!--Bus Controller-->
<BC />
</M1553>
</Device>
</AV_Configuration>
```

1553 Data Table

A sample *AltaView* XML configuration file for a 1553 Data Table is provided here:

```
<?xml version="1.0" encoding="utf-16"?>
<!--XML File for AltaView 1553 Data Table-->
<AV_1553_Data_Table>
  <M1553_BM_DataTable_Page PageName="RT 1-R-SA 1" PageIndex="0">
    <M1553_BM_DataTable_Parameter ParamName="Latitude" ParamUnits="Direction"
    ParamFormat="DECIMAL" SrcRT="1" SrcTR="0" SrcSA="1" SrcWord="0" SrcNumWds="1">
      <M1553_BM_DataTable_Parameter_Field_COD MSB="15" LSB="14">
        <M1553_BM_DataTable_Parameter_Field_COD_ValString Value="0" String="North" />
        <M1553_BM_DataTable_Parameter_Field_COD_ValString Value="1" String="No Computed
Data" />
        <M1553_BM_DataTable_Parameter_Field_COD_ValString Value="2" String="Functional
Test" />
        <M1553_BM_DataTable_Parameter_Field_COD_ValString Value="3" String="South" />
      </M1553_BM_DataTable_Parameter_Field_COD>
    </M1553_BM_DataTable_Parameter>
    <M1553_BM_DataTable_Parameter ParamName="Latitude" ParamUnits="Degrees"
    ParamFormat="DECIMAL" SrcRT="1" SrcTR="0" SrcSA="1" SrcWord="0" SrcNumWds="2">
      <M1553_BM_DataTable_Parameter_Field_BCD MSB="23" LSB="0" NumDigits="6" MsdSize="4"
    DigitSize="4" MinVal="0" MaxVal="90" />
    </M1553_BM_DataTable_Parameter>
    <M1553_BM_DataTable_Parameter ParamName="Longitude" ParamUnits="Direction"
    ParamFormat="DECIMAL" SrcRT="1" SrcTR="0" SrcSA="1" SrcWord="2" SrcNumWds="1">
      <M1553_BM_DataTable_Parameter_Field_COD MSB="15" LSB="14">
        <M1553_BM_DataTable_Parameter_Field_COD_ValString Value="0" String="East" />
        <M1553_BM_DataTable_Parameter_Field_COD_ValString Value="1" String="No Computed
Data" />
        <M1553_BM_DataTable_Parameter_Field_COD_ValString Value="2" String="Functional
Test" />
        <M1553_BM_DataTable_Parameter_Field_COD_ValString Value="3" String="West" />
      </M1553_BM_DataTable_Parameter_Field_COD>
    </M1553_BM_DataTable_Parameter>
    <M1553_BM_DataTable_Parameter ParamName="Longitude" ParamUnits="Degrees"
    ParamFormat="DECIMAL" SrcRT="1" SrcTR="0" SrcSA="1" SrcWord="2" SrcNumWds="2">
      <M1553_BM_DataTable_Parameter_Field_BCD MSB="27" LSB="0" NumDigits="7" MsdSize="4"
    DigitSize="4" MinVal="0" MaxVal="180" />
    </M1553_BM_DataTable_Parameter>
    <M1553_BM_DataTable_Parameter ParamName="UTC-Hours" ParamUnits="Hours"
    ParamFormat="DECIMAL" SrcRT="1" SrcTR="0" SrcSA="1" SrcWord="4" SrcNumWds="2">
      <M1553_BM_DataTable_Parameter_Field_BCD MSB="19" LSB="12" NumDigits="2" MsdSize="4"
    DigitSize="4" MinVal="0" MaxVal="23" />
    </M1553_BM_DataTable_Parameter>
    <M1553_BM_DataTable_Parameter ParamName="UTC-Minutes" ParamUnits="Minutes"
    ParamFormat="DECIMAL" SrcRT="1" SrcTR="0" SrcSA="1" SrcWord="4" SrcNumWds="2">
      <M1553_BM_DataTable_Parameter_Field_BCD MSB="11" LSB="0" NumDigits="3" MsdSize="4"
    DigitSize="4" MinVal="0" MaxVal="59.9" />
    </M1553_BM_DataTable_Parameter>
    <M1553_BM_DataTable_Parameter ParamName="1750A Float" ParamUnits=""
    ParamFormat="DECIMAL" SrcRT="1" SrcTR="0" SrcSA="1" SrcWord="6" SrcNumWds="2">
      <M1553_BM_DataTable_Parameter_Field_FLT MSB="31" LSB="0" Slope="1" Offset="0" />
    </M1553_BM_DataTable_Parameter>
    <M1553_BM_DataTable_Parameter ParamName="IEEE 754 w/ Slope" ParamUnits=""
    ParamFormat="DECIMAL" SrcRT="1" SrcTR="0" SrcSA="1" SrcWord="8" SrcNumWds="2">
      <M1553_BM_DataTable_Parameter_Field_754FLT MSB="31" LSB="0" Slope="0.33333"
    Offset="1.5" />
    </M1553_BM_DataTable_Parameter>
  </M1553_BM_DataTable_Page>
</AV_1553_Data_Table>
```

A429 Configuration File

A sample *AltaView* XML configuration file for A429 is provided here:

```
<?xml version="1.0" encoding="utf-16"?>
<!--XML File for AltaView Settings-->
<AV_Configuration AV_Version="3.0.2.1">
  <AV_INTRO ShowIntro="False" />
  <CULTURE Localization="en-US" />
  <QAT Layout="0,logoOpenDevicebutton,logoLoadConfigbutton,logoSaveConfigbutton" />
  <eNet_Server_IP_Address IPAddr="192.168.0.128" />
  <Device DevID="01002000" DevName="SIM-A429 Bd 1 A429 Bank 1" Remote="false"
ipAddr="localhost" tcpPort="9000" serverIpAddr="localhost" clientIpAddr="localhost"
DevColor="-16776961">
  <!--A429 Device Settings-->
  <A429>
    <!--Playback Mode-->
    <A429_PlaybackMode PlaybackMode="False" />
    <!--Channel Settings-->
    <A429_Channel_Settings Channel="0" BitRateHz="100000" EQID="4096" />
    <A429_Channel_Settings Channel="1" BitRateHz="100000" EQID="4096" />
    <A429_Channel_Settings Channel="2" BitRateHz="100000" EQID="4096" />
    <A429_Channel_Settings Channel="3" BitRateHz="100000" EQID="4096" />
    <A429_Channel_Settings Channel="4" BitRateHz="100000" EQID="4096" />
    <A429_Channel_Settings Channel="5" BitRateHz="100000" EQID="4096" />
    <A429_Channel_Settings Channel="6" BitRateHz="100000" EQID="4096" />
    <A429_Channel_Settings Channel="7" BitRateHz="100000" EQID="4096" />
    <A429_Channel_Settings Channel="8" BitRateHz="100000" EQID="4096" />
    <A429_Channel_Settings Channel="9" BitRateHz="100000" EQID="4096" />
    <A429_Channel_Settings Channel="10" BitRateHz="100000" EQID="4096" />
    <A429_Channel_Settings Channel="11" BitRateHz="100000" EQID="4096" />
    <A429_Channel_Settings Channel="12" BitRateHz="100000" EQID="4096" />
    <A429_Channel_Settings Channel="13" BitRateHz="100000" EQID="4096" />
    <A429_Channel_Settings Channel="14" BitRateHz="100000" EQID="4096" />
    <A429_Channel_Settings Channel="15" BitRateHz="100000" EQID="4096" />
    <!--A429 RX-->
    <RX>
      <A429_RX_InitAction Run="false" />
      <A429_RX_Log Enabled="false" Filename="Browse for file" IncrFileName="true"
DayTimeFileName="false" FileBreakOption="None" FileBreakTimeMin="30"
FileBreakSizeMB="100" FileBreakMsgCnt="10000" />
      <A429_RX_Trigger Mode="0" Channel="16" Mask="00000000" Value="FFFFFFFF"
GenTrgOut="False" PreTrigger="0" />
    </RX>
    <!--A429 TX-->
    <TX />
  </A429>
</Device>
<MAIN_FORM_SETTINGS State="Normal" Top="2" Left="2" Width="850" Height="499">
  <DEVICE_FORM_SETTINGS Index="0" State="Normal" Top="0" Left="0" Width="394"
Height="200">
    <A429_RXCP_FORM_SETTINGS Index="0" State="Normal" Top="166" Left="864" Width="869"
Height="620" />
  </DEVICE_FORM_SETTINGS>
</MAIN_FORM_SETTINGS>
</AV_Configuration>
```

Appendix C – File Formats

This Appendix describes the file formats used for *AltaView* data.

1553 BM Data (CDP Files)

The 1553 Bus Monitor stores message data in CDP files (.cdp extension). Each message is stored in a “Common Data Packet” (CDP) format. The file format has no header or footer – the file consists of nothing more than a series of CDP records where each record represents one 1553 message.

The Common Data Packet consists of 49 words (196 bytes) in the following format:

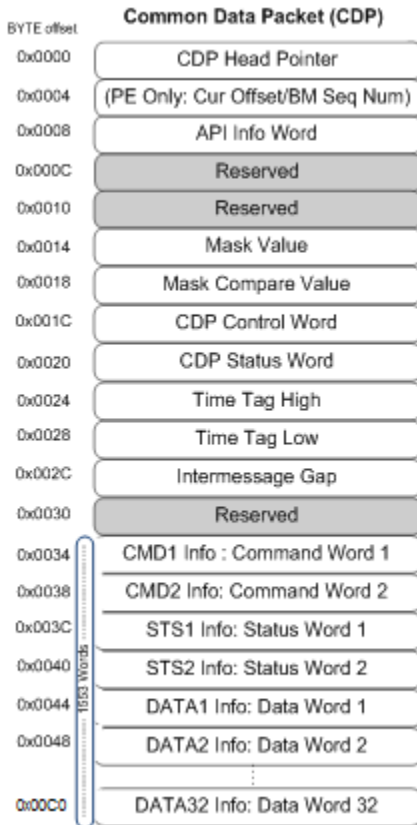

The first eight words can be ignored when handling CDP BM message data. The useful information is found in the CDP Status Word, time tag words, gap word, and message CMD, STS, and DATA words.

The CDP Status Word uses the following format:

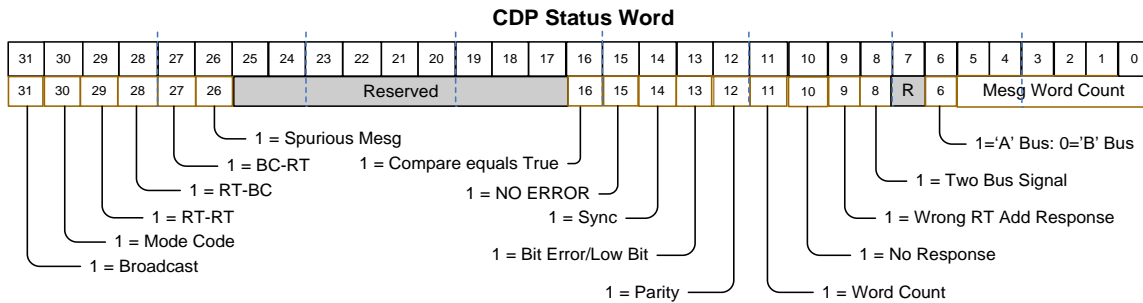

This word provides information on the message type in bits 26-31, message-level error information in bits 8-15, the bus the message occurred on in bit 6, and the count of DATA words in the message in bits 0-5.

The CMD, STS, and DATA words from the 1553 message use the following format:

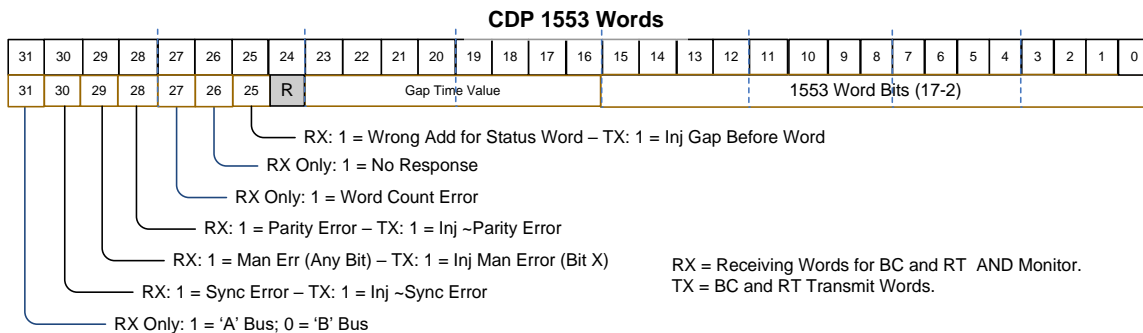

The upper 16-bits provide information on which bus the word was on, any errors on the word and the dead-bus gap time (100ns LSB) from the previous word. The lower 16-bits contains the actual 1553 word (CMD, STS, or DATA).

Refer to the *AltaCore* 1553 reference manual for more information on the CDP.

A429 RX Data (RXP Files)

The A429 MCRX stores message data in RXP files (.rxp extension). Each message is stored in a “Receive Packet” (RXP) format. The file format has no header or footer – the file consists of nothing more than a series of RXP records where each record represents one A429 label.

The Receive Packet consists of 4 words (16 bytes) in the following format:

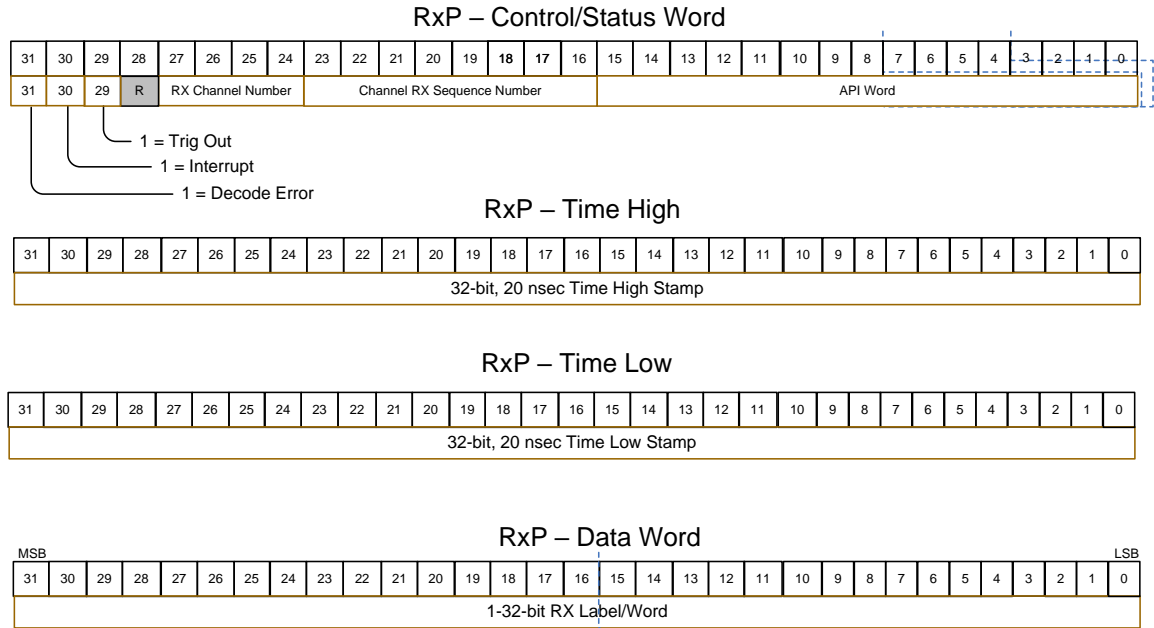

The RXP Control/Status word contains information like RX channel number (0-15) and an error flag (decode error). Next is the 64-bit 20ns LSB time-stamp. Finally we have the 32-bit A429 data word.

Refer to the *AltaCore* A429 reference manual for more information on the RXP.

WMUX BM Data (CWP Files)

The WMUX Bus Monitor stores message data in CWP files (.cwp extension). Each message is stored in a WMUX “Common Data Packet” (WMUX CDP) format. The file format has no header or footer – the file consists of nothing more than a series of WMUX CDP records where each record represents one WMUX message. Note – do not confuse WMUX CDP records with 1553 CDP records, these are different protocols with different CDP formats.

The WMUX Common Data Packet consists of 28 words (112 bytes) in the following format:

BYTE offset	Common Data Packet (CDP)
0x0000	CDP Head Pointer
0x0004	(PE Only: Cur Offset/BM Seq Num)
0x0008	API Info Word
0x000C	Reserved
0x0010	
0x0014	
0x0018	
0x001C	CDP Control Word
0x0020	CDP Status Word
0x0024	Time Tag High
0x0028	Time Tag Low
0x002C	Intermessage Gap
0x0030	CIU Data 1/Reset - Overhead
0x0034	CIU Data 1/Reset
0x0038	CIU Data 2 - Overhead
0x003C	CIU Data 2
0x0040	CIU Go-No Go 1 - Overhead
0x0044	CIU Data 3: Go-No Go 1
0x0048	CIU Go-No Go 2 - Overhead
0x004C	CIU Data 4: Go-No Go 2
0x0050	RIU Data 1 Echo – Overhead
0x0054	RIU Data 1: Echo
0x0058	RIU Status – Overhead
0x005C	RIU Data 2: Status
0x0060	RIU Data 1 Echo – Overhead (RIU Duplicate Bus – Mon Only)
0x0064	RIU Data 1 Echo (RIU Duplicate Bus – Mon Only)
0x0068	RIU Status – Overhead (RIU Duplicate Bus – Mon Only)
0x006C	RIU Status (RIU Duplicate Bus – Mon Only)

The first seven words can be ignored when handling CDP BM message data. The useful information is found in the CDP Status Word, time tag words, gap word, and message CIU and RIU words.

The CDP Status Word uses the following format:

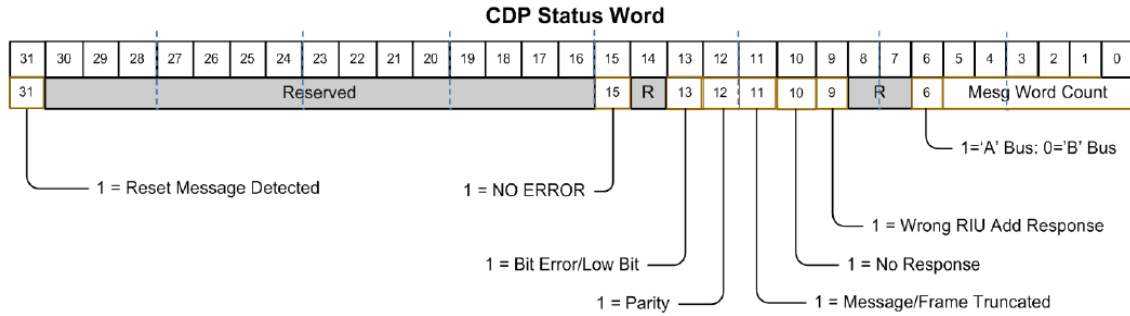

This word provides information on the message-level error information in bits 9-15, the bus the message occurred on in bit 6, and the count of words in the message in bits 0-5.

The OVERHEAD and DATA words for the message use the following formats:

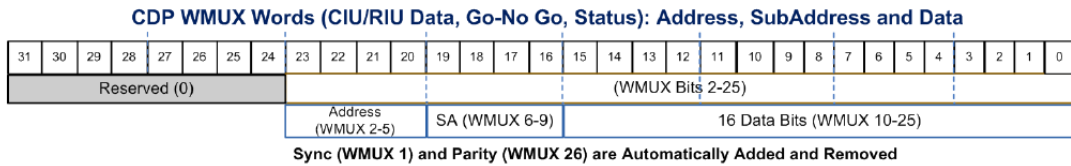
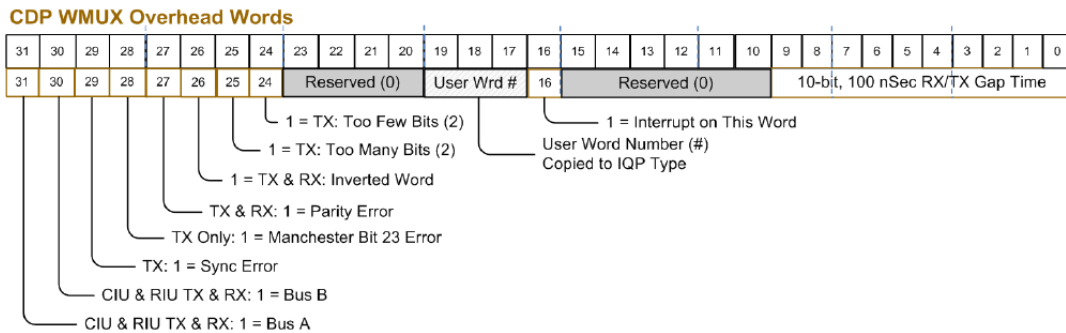

The overhead words provide information on which bus the word was on, any errors on the word and the dead-bus gap time (100ns LSB) from the previous word. The CIU/RIU words contain the actual WMUX words in the message.

Refer to the **AltaCore** WMUX manual for more information on the CDP.

Appendix D – Remote Operation

This Appendix discusses using *AltaView* with remote devices over a network. The Alta software uses the **Microsoft™ .NET framework** for remote operation. This is done by instantiating the Layer 1 .NET API (ADT_L1_NET20) as a “remote object” using standard .NET methods. All interaction with this object is marshaled over the network by the .NET framework.

WARNING – Communicating with the Alta board over a network is considerably slower than communicating with a local board. This should only be done when relatively low bus traffic is expected. Performance can vary widely based on the network configuration and traffic conditions. Alta does NOT guarantee operation over your network. If you experience problems with remote operation you may have to switch to local operation.

Remote operation is considered a “legacy feature” that few people still use, and is not recommended for new applications.

Running the Alta Server

The first step to setup remote operation is to start the Alta Server on the remote system. This system must have an Alta board and software installed. The Alta Server application is available from the Windows Program Menu under the Alta Data Technologies group.

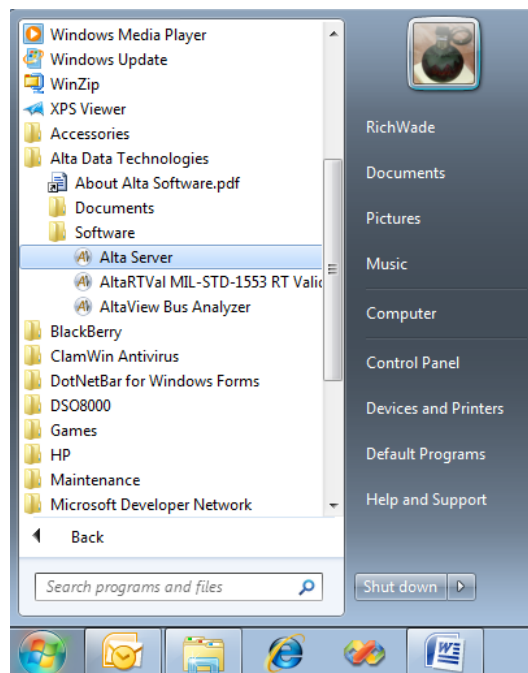

The Alta Server application is very simple – just select a TCP port number and click the button to start the server.

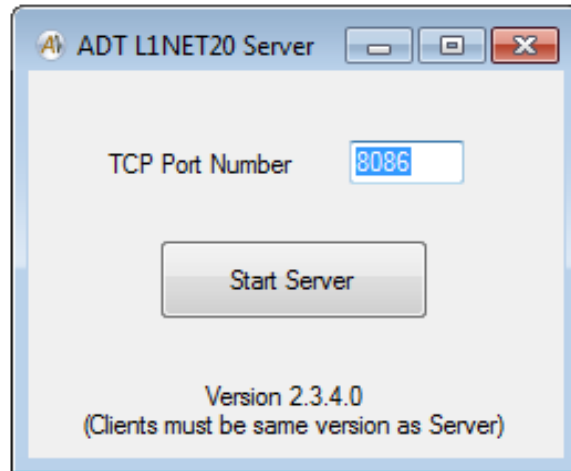

After you have started the server it is now ready to accept connections from a client. Note that you may have to configure your firewall or make other network configuration changes to allow access to the computer through the specified TCP port number. You do, of course, need to know the IP Address of the system running the Alta server.

Running the *AltaView* Client

When you open a device from *AltaView* you can select a local or remote device. Note that only local devices are displayed in the tree on the left side of the “Open Alta Device” dialog – you will not see any remote devices in this tree.

Select the “Remote” option (radio button under “Network Options”). Enter the IP address of the remote system and the TCP port number to use (same port number selected when you started the server) in the appropriate text boxes.

The Device ID selections (board type, board number, channel type, channel number) now refer to the remote system.

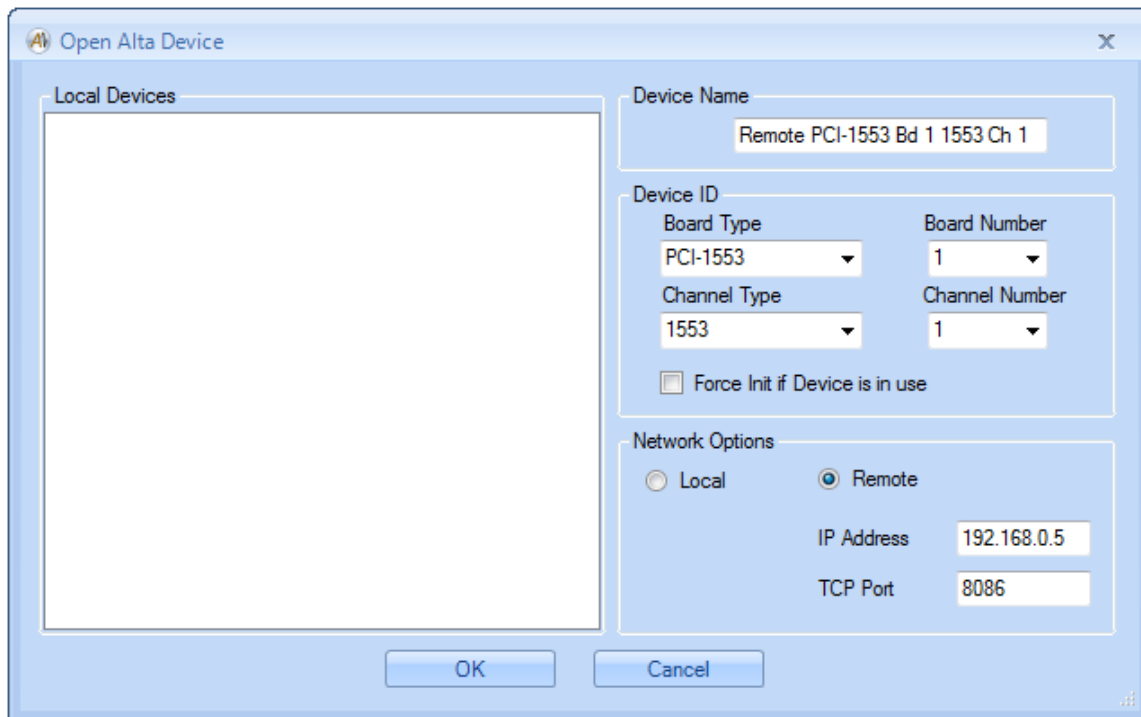

The example above will open PCI-1553 board 1, 1553 channel 1 on the remote system at IP address 192.168.0.5 using TCP port 8086.

The software (and the .NET framework) will now work with the remote device. As noted earlier, you may notice that *AltaView* runs slower when using a remote device.

WARNING – Both the Client and Server systems should have the SAME VERSION of the Alta Software installed. The client-server connection may not work if there are different software versions on the two systems.

WARNING – Do not close the Alta Server application while clients are connected. Close client connections before closing the server.

Appendix E – Enabled Features - 1553

	Dual Function	Full Function	Dual Function w/ Analyzer	Full Function w/ Analyzer
1553 Options	NO	NO	YES	YES
Time Options	NO	NO	YES	YES
User Names	NO	NO	YES	YES
1553 BM Control Panel	YES	YES	YES	YES
1553 BM File Viewer	YES	YES	YES	YES
1553 BM Current Value Viewer	YES	YES	YES	YES
1553 BM Snapshot Viewer	NO	NO	YES	YES
1553 BM Activity Viewer	NO	NO	YES	YES
1553 BM Archive to File	NO	NO	YES	YES
1553 BM Triggers	NO	NO	YES	YES
1553 Signal Viewer	NO	NO	YES ⁽²⁾	YES ⁽²⁾
1553 BM Data Table	NO	NO	YES	YES
1553 RT Control Panel	YES ⁽¹⁾	YES	YES ⁽¹⁾	YES
Add All RTs	NO	NO	YES ⁽¹⁾	YES
Set Response Time	NO	NO	YES ⁽¹⁾	YES
Enable/Disable RT	NO	NO	YES ⁽¹⁾	YES
RT Status Word Bits	NO	NO	YES ⁽¹⁾	YES
Legalization	NO	NO	YES ⁽¹⁾	YES
RT Error Injection	NO	NO	YES ⁽¹⁾	YES
RT Pattern Data	NO	NO	YES ⁽¹⁾	YES
1553 BC Control Panel	YES ⁽¹⁾	YES	YES ⁽¹⁾	YES
1553 BC Error Injection	NO	NO	YES ⁽¹⁾	YES
1553 BC Message Enable/Disable	NO	NO	YES ⁽¹⁾	YES
1553 BC Triggers	NO	NO	YES ⁽¹⁾	YES
BC Pattern Data	NO	NO	YES ⁽¹⁾	YES
1553 PB Control Panel	NO	NO	YES ⁽³⁾	YES

- (1) Beginning with **AltaView** v3.1.1.0, when opening a 1553 channel on a dual-function device, the operator is prompted to open the channel in either RT or BC mode. Functionality for the mode not chosen is disabled
- (2) The 1553 Signal Viewer is only enabled for channels that have the A/D converter necessary for this function. Not available on PMC-1553, PC104P-1553, PC104E-MA4, ENET-1553-EBR.
- (3) Playback mode is enabled when a Single-Function or Dual-Function channel is opened in BC mode.

NOTE: ENET-1553-EBR devices all have analyzer capability.

Appendix F – Enabled Features – ARINC-429

	Standard	Standard with Analyzer
EQID/Label Editor	NO	YES
Channel Settings	YES	YES
A429 RX Control Panel	YES	YES
A429 RX File Viewer	YES	YES
A429 RX Current Value Viewer	YES	YES
A429 RX Snapshot Viewer	NO	YES
A429 RX Archive to File	NO	YES
A429 RX Triggers	NO	YES
A429 RX Signal Viewer	NO	YES ⁽¹⁾
A429 RX Data Table	NO	YES
A429 TX Control Panel	YES	YES
A429 PB Control Panel	NO	YES

- (1) The A429 Signal Viewer is only enabled for receive channels that have the A/D converter necessary for this function. Channels 4 and 5 provide the A429 Signal Viewer function for the ENET-A429P. All other A429 devices have the Signal Viewer enabled on the first and second RX channels. Not available on PMC-A429, PC104P-A429, PC104E-MA4.

Appendix G – Enabled Features – WMUX

	Full Function	Full Function with Analyzer
Time Options	NO	YES
WMUX BM Control Panel	YES	YES
WMUX BM File Viewer	YES	YES
WMUX BM Current Value Viewer	YES	YES
WMUX BM Snapshot Viewer	NO	YES
WMUX BM Archive to File	NO	YES
WMUX RIU Control Panel	YES	YES
Enable/Disable RIU	NO	YES
RIU Error Injection	NO	YES
WMUX CIU Control Panel	YES	YES
WMUX CIU Error Injection	NO	YES
WMUX CIU Message Enable/Disable	NO	YES

Appendix H – Enabled Features – ENET-1553-EBR

	Single Function
1553 Options	YES
Time Options	YES
User Names	YES
1553 BM Control Panel	YES
1553 BM File Viewer	YES
1553 BM Current Value Viewer	YES
1553 BM Snapshot Viewer	YES
1553 BM Archive to File	YES
1553 BM Triggers	YES
1553 Signal Viewer	YES
1553 BM Data Table	YES
	YES
1553 RT Control Panel	
Set Response Time	YES
Enable/Disable RT	YES
RT Status Word Bits	YES
Legalization	YES
RT Error Injection	YES
RT Pattern Data	YES
1553 BC Control Panel	YES
1553 BC Error Injection	YES
1553 BC Message Enable/Disable	YES
1553 BC Triggers	YES
BC Pattern Data	YES
1553 PB Control Panel	YES

Note: Beginning with *AltaView* v3.1.0.4, when opening a 1553 channel on an ENET-1553-EBR device, the operator is prompted to open the channel in either BM or RT or BC mode. Functionality for the two modes not chosen is disabled.

Appendix I – Alta ENET UDP Protocols

This Appendix discusses the UDP protocols used with Alta ENET devices. **ADCP** (Alta Device Control Protocol) is used by *AltaView* to control ENET devices over a network. **APMP** (Alta Passive Monitor Protocol) is an optional protocol used to broadcast bus monitor data on the network – this protocol is not currently used by the *AltaView* software.

The following text is an excerpt from **Alta document 10401-10000-A0** (ADT UDP Protocol Definitions).

1. SCOPE

This document describes the UDP protocols used with Alta eNET products. These protocols are used to communicate with Alta eNET devices over an Ethernet network.

2. REFERENCES

- AltaAPI Users Manual
- IETF RFC 768 User Datagram Protocol
- IETF RFC 791 Internet Protocol v4
- IEEE 802.3 Ethernet

3. ALTA DEVICE CONTROL PROTOCOL (ADCP)

The Alta Device Control Protocol (ADCP) is used by the AltaAPI to control eNET devices, primarily through operations that reset the device or perform memory read/write accesses on the device. This protocol is implemented in the data payload of UDP packets.

3.1 General Description

The Alta eNET device is the ADCP Server, which responds to commands from a controller Client. The Server does not send anything until commanded to do so by the Client. ADCP is a command-response protocol where the controller Client initiates all transactions and the Server eNET device only sends packets in response to commands from the Client. The controller Client sends a command and waits for a response from the Server. The Client does not send another command until the current command is complete (response received from the Server or no response time-out).

3.2 UDP Port Numbers

The ADCP Server will always be UDP port number 55512. ADCP Clients will start at UDP port number 55513 – if the port is already in use the Client will increment the port number until it finds one that is available.

3.3 Basic Operations

The controller client performs all operations with single UDP packets, where each packet is a command to the device. The basic operations are:

1. Reset the device
2. Read from device main memory (16-bit or 32-bit)
3. Write to device main memory (16-bit or 32-bit)
4. Read from device setup memory (32-bit)
5. Write to device setup memory (32-bit)

The 32-bit reads/writes in main memory are used for normal device operation. The 16-bit reads/writes in main memory and the 32-bit reads/writes in setup memory are only used when programming the Protocol Engine firmware load into flash memory. For comparison to Alta board-level products, the Alta PCI/PCle devices map main memory to BAR2 and map setup memory to BAR0.

3.4 Error Detection and Error Handling

The Ethernet packet includes a Frame Check Sequence using a 32-bit Cyclic Redundancy Check (CRC). This is generated for transmitted packets and checked for received packets at the MAC level. If the Server detects any MAC errors (including CRC errors) in the command packet from the Client, the Server will not process the command and it will send a response packet to the Client with a failure status code.

The ADCP packet header contains a Sequence Number which is generated by the controller Client. This is used to detect dropped packets. The Server eNET device responds to a command by sending a response packet back to the Client with the same Sequence Number that it received in the command packet. This response packet is the acknowledgement from the Server to the Client to indicate that the command was received.

If the Client receives a response from the Server with the wrong Sequence Number, with a failure status code, or if the Client does not receive a response at all (and times-out), it can send the command again.

The time-out period to wait for a response from the Server is determined by the client application, but a recommended value is a minimum of 50 milliseconds. Likewise, the maximum number of times that the client will retry sending a

command packet is determined by the application, but a recommended number is three retries.

3.5 ADCP Packet Format

The following diagram shows the ADCP packet format:

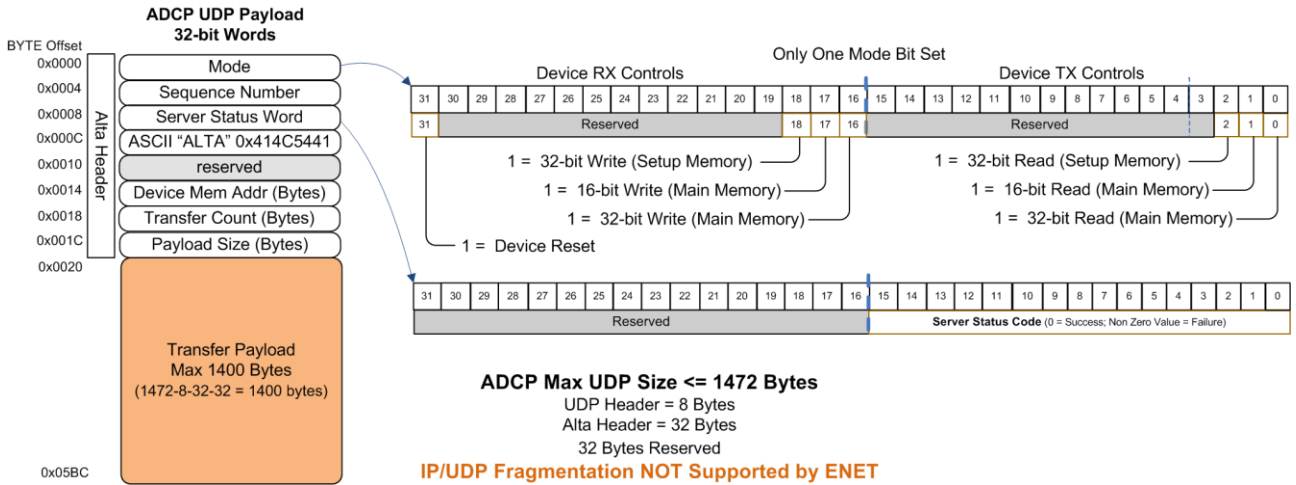

All values in the packet are in "Big-Endian" format. The 32-bit value 0xA1B2C3D4 would be stored as follows:

- First Byte: 0xA1
- Second Byte: 0xB2
- Third Byte: 0xC3
- Fourth Byte: 0xD4

The controller Client sends command packets to the Server. The Server performs the requested operation (as specified in the Mode word) and sends a response packet back to the Client. The response packet includes the Server Status Word, which indicates SUCCESS or FAILURE. If the Server detected any errors in the command packet it will indicate FAILURE in the response packet. The response packet sent by the Server will always use the same Sequence Number that it received in the corresponding command packet.

For memory read/write operations, the ADCP header includes the starting byte address (Device Mem Addr) and the number of bytes (Transfer Count). For memory write operations, the Client sends the words to be written in the Transfer Payload of the command packet. For memory read operations, the Server sends the words read in the Transfer Payload of the response packet. As with all words

in the packet, the Transfer Payload will store 32-bit and 16-bit words in “Big-Endian” format.

Here are some examples:

If the Client wants to read 49 32-bit words from main memory starting at byte address 0x10000 it would send a command packet with a Mode word of 0x00000001 (32-bit read from main memory), the next sequence number (let's use 0x12345678 for this example), zero in the next four words of the header, a Device Mem Addr of 0x00010000, and a Transfer Count of 0x000000C4 ($49 * 4 = 196 = 0xC4$). There would be no words in the Transfer Payload of the command packet, so the Payload Size will be zero. When the Server receives this packet it will perform the read operation and send a response packet back to the Client. The Mode word will be 0x00000001 (same as command packet), the Sequence Number will be 0x12345678 (same as command packet), assuming there were no errors the Server Status will be 0x00000000 (indicating SUCCESS), the Device Mem Addr will be 0x00010000 (same as command packet), and the Transfer Count will be 0x000000C4 (same as command packet). The Payload Size will also be 0x000000C4 and the Transfer Payload will contain the words read from memory.

If the Client wants to write 49 32-bit words to main memory starting at byte address 0x10000 it would send a command packet with a Mode Word of 0x00010000 (32-bit write to main memory), the next sequence number (let's use 0x12345679), zero in the next four words of the header, a Device Mem Addr of 0x00010000, a Transfer Count of 0x000000C4, and a Payload Size of 0x000000C4, with the data to be written in the Transfer Payload. When the Server receives this packet it will perform the write operation and send a response packet back to the Client. The Mode word will be 0x00010000 (same as command packet), the Sequence Number will be 0x12345679 (same as command packet), assuming there were no errors the Server Status will be 0x00000000 (indicating SUCCESS), the Device Mem Addr will be 0x00010000 (same as command packet), and the Transfer Count will be 0x000000C4 (same as command packet). The Payload Size will be zero because there are no words in the Transfer Payload.

4. ALTA PASSIVE MONITOR PROTOCOL (APMP)

The Alta Passive Monitor Protocol (APMP) is used by eNET devices in the monitor-only state where information monitored by the device is broadcast on the Ethernet network so anyone on the network can receive the data. This protocol does not allow any control of the device. The device does not receive any packets, it only sends packets as it captures monitor data. This protocol is implemented in the data payload of UDP packets.

4.1 General Description

The Alta eNET device is the APMP Server, which transmits packets as it receives messages on the data bus (1553, A429, etc.). Clients only receive packets, they do not transmit packets. The Server only transmits packets, it does not receive packets.

4.2 UDP Port Numbers

Each ENET device will use a fixed pair of Server and Client port numbers. These port numbers will be programmed into flash memory on the device when it is configured for APMP operation.

	Device 1	Device 2	Device 3	Device 4
ENET-1553 APMP Server Port Number	56512	56514	56516	56518
ENET-1553 APMP Client Port Number	56513	56515	56517	56519
ENET-A429 APMP Server Port Number	56768	56770	56772	56774
ENET-A429 APMP Client Port Number	56769	56771	56773	56775

The 2-channel ENET2-1553 will be TWO devices (one for each channel). If the ENET2-1553 is set to be device 1, then the first channel is device 1 and the second channel is device 2.

4.3 Basic Operations

There is only one operation for APMP. The Server sends single UDP broadcast packets (this may use a destination IP address of 255.255.255.255, or a subnet broadcast address like 192.168.0.255 – this should be), where each packet contains a message received on the data bus (1553, A429, etc.).

4.4 Error Detection and Error Handling

The Ethernet packet includes a Frame Check Sequence using a 32-bit Cyclic Redundancy Check (CRC). This is generated for transmitted packets and checked for received packets at the MAC level. If the Client detects any MAC errors (including CRC errors) in the APMP packet from the Server, the Client will discard the packet and will not use the data.

4.5 APMP Packet Format

The following diagram shows the APMP packet format:

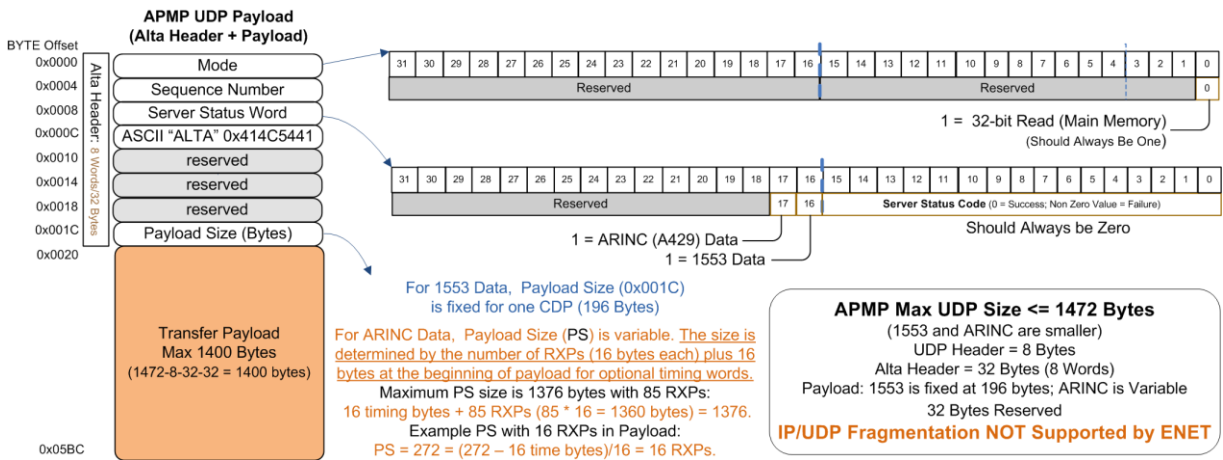

All values in the packet are in “Big-Endian” format. The 32-bit value 0xA1B2C3D4 would be stored as follows:

First Byte: 0xA1
Second Byte: 0xB2
Third Byte: 0xC3
Fourth Byte: 0xD4

The APMP packet format is very similar to the ADCP packet format, and is basically a subset of the ADCP format. The Mode word should always be 0x00000001 (32-bit Read of main memory). The Server Status Word should always have 0x0000 (Success) in the Server Status Code and indicates the Payload Data Type (1553 message or A429 label) in the upper 16 bits. The Payload Size word contains the number of bytes in the Transfer Payload.

For 1553 message data, the Transfer Payload will contain the Alta 1553 Common Data Packet (CDP), which is 49 words (196 bytes).

For A429 label data, the Transfer Payload will contain 4 words (16 bytes) which can be used for IRIG time or Interval Timer, or zero if unused, followed by 1 to 85 of the Alta A429 Receive Packets (RXPs), each of which is 4 words (16 bytes).

Manual Revision Information

Date	Rev	Description
5/31/10	H8	Updated for version 2.3.2.0 release.
8/3/10	H9	Added Revision Information Block. Updated Appendix D to clarify usage of the Alta Server with a remote connection from AltaView.
9/16/10	I1	Updated the section on the Global Control Panel Variable Voltage settings to reflect the addition of a text box for entering the desired voltage value. Updated the section on the 1553 Bus Controller, added the buttons for “ALL MSGS BUS A” and “ALL MSGS BUS B”.
11/3/10	I2	Updated the 1553 RT and 1553 BC sections to add the “Buffer Name” field in the “Edit Buffer” dialogs. Updated the section on the “Open Device” dialog to include the “Mem Test” check box. Updated the section on the Global Control Panel IRIG calibration (for changes in v2.4.1.0).
2/18/11	I3	Updates for version 2.5.0.0. Updated the 1553 BC section to add Aperiodic Message support. Updated the 1553 BM section to clarify how the Current Value Viewer handles messages to a given RT/TR/SA on both busses. Added a discussion on ENET Devices (in the section on “Managing Devices”. Added Appendix F (ENET UDP Protocols). Updated the section on the 1553 User Names dialog (now can specify user names for Bus A and Bus B).
5/9/11	I4	Corrected minor error in the description of 1553 BM Snapshot Viewer. Added note explaining that double-clicking on the device information form will display the Layer 0 and Layer 1 API versions. Updated screen shots in 1553 BM discussion.
7/5/11	I5	Updated Global Tools – Localization Tools to include Italian, added description of the ENET Tools.
8/29/11	I6	Updates for v2.5.3.0 – Archiving Options added for 1553 BM, 1553 APMP, and A429 RX.
10/31/11	I7	Updates for v2.5.4.0 – Updated Global ENET Config Dialog. Updated 1553 Options Dialog.
1/5/12	I8	Updates for v2.5.5.0 – Updated 1553 BM Search Tool for new comparison options in Data Tab. Added BM Software Triggers and Snapshot Viewer Triggered Snapshot menu-strip item.
3/7/12	I9	Clarified 1553 BM Triggered Snapshot description.

3/23/12	J1	Updates for v2.5.6.0 – Updated section on the A429 RX Control Panel – Discovery Tree and associated tools now have the SDI level in addition to the Label level.
9/17/12	J2	Updates for v2.5.7.0 – Added clarification on BM Triggers. Added discussion of A429 APMP Control Panel.
2/5/13	J3	Updates for v2.6.0.0 – Updated A429 Data Table, Updated Device Info form with time information.
2/6/13	J4	Updated NAICS Code.
2/8/13	J5	Updated for change to IRIG “no-lock” indicators – color change from RED to YELLOW.
7/18/13	J6	Updated description of APMP protocol – port number usage. ENET Config and APMP Control Panel – added APMP Device Number. Added 1553 BM Control Panel, Statistics, Save to File. Updated 1553 and A429 Signal Viewer description to include Save to JPG File option. Added section on EBR1553 operation. Updated description of the ENET Config dialog. Added clarification on the A429 EQID/Label editor and files. Added a discussion of time-stamps and AltaView conventions for year/day/time. Updated discussion of ENET Path Delay. Added discussion of the Splash Page and the Default Configuration File.
11/7/13	J7	Minor correction to CDP diagram.
3/20/14	J8	ADDED CHAPTER ON WMUX TOOLS. Added “WP” capability code. Various updates related to WMUX.
4/24/14	J9	Added warning on using ENET Config dialog while anything else is running on the device (conflict with memory reads while accessing flash memory). Added the LOG FILE dialog for Program Flash.
9/17/14	K1	Updated WMUX RIU Error Injection to add response bus selection. Updated WMUX CIU Control Panel to add CIU Options for Master Reset. Updated 1553 BC and RT Control Panels to add the “Pattern Data” button. Added error code descriptions for 1553 BM and WMUX BM.
11/10/14	K2	Updated 1553 BM Control Panel to add “Auto Expand” menu-strip item. Added section on Managing AltaView Windows. Updated section on A429 RX Data Table.
2/25/15	K3	Added discussion of IRIG time codes (Global Control Panel). Updated section on A429 playback. Changed max number of labels per TX channel from 100 to 256. Added Chapter 0 – System Settings. Added discussion of time formats.
5/14/15	K4	Added warning and notes on 1553 Signal Viewer.

9/21/15	K5	Updated section on 1553 Data Table, added file Save/Load.
6/1/16	K6	Updated section on ENET Config. Updated section on programming flash. Updated section on A429 RX Triggers.
8/14/17	K7	<ul style="list-style-type: none"> • Updated 'Splash Page and the Default Configuration File' section to provide new location of the AV_Default.xml file and discuss how updates to the default configuration are now handled. • Updated 'Managing Devices' section to discuss new 'Device Configuration Info' icon on Device Info window. • Added 'A429 Output Voltage' section to illustrate use of the A429P output voltage controls. • Added references for ENET-A429P where needed. • Added 'Find Timestamp' section to discuss the Find Timestamp search option in the A429 RX File Viewer. • Added 'Find Timestamp' section to discuss the Find Timestamp search option in the 1553 BM File Viewer. • Updated 'Managing AltaView Files' section to discuss the use of the 'AltaView Files' folder. • Updated 'Open Device' section with statement regarding opening ENET devices. Also added 'SF' to capability code table. • Updated 'Bus Monitor Tools', 'Remote Terminal Tools' and 'Bus Controller Tools' sections to discuss operation with single- and dual-function devices. • Removed references to Windows XP, Windows Vista and Windows Server 2003. Software release 3.0.2.1 was the last release to support these operating systems. • Updated 1553 Enabled Features in Appendix E to reflect changes relating to dual- and single-function devices. Appendix was then split into separate appendixes for 1553, A429 and WMUX. 'Alta ENET UDP Protocols' is now Appendix H. • Added new 'RT/SA Filters' section in 'ENET Config' discussion to highlight new feature.
09/14/17	K8	<ul style="list-style-type: none"> • Updated section 'Program FLASH' to add new pop-up message when active channels are detected on the Alta device. • Updated section 'ENET Config' to add new pop-up message when active channels are detected on the ENET device.
10/12/17	K9	<ul style="list-style-type: none"> • Removed line specifying API Version that this document relates to.

		This was forcing a manual update when no manual changes were made.
08/27/18	L1	<ul style="list-style-type: none"> Removed ENET Config “Detecting Active Devices” pop-up
01/16/19	L2	<ul style="list-style-type: none"> Modified Enabled Features tables to separate ENET-1553-EBR device enabled features.
04/06/20	L3	<ul style="list-style-type: none"> Updated ENET Config Control Panel image to reflect current Added description for UDP/APMP Send Interval entry in ENET Config Added description for CVT Label Filter entry in ENET Config Updated A429 RX Control Panel image to reflect current
09/16/20	L4	<ul style="list-style-type: none"> Updated ENET Config Control Panel image to reflect current one Added new images and text for the Test Signal tab of the 1553 Signal Viewer dialog. Updated note on Signal Viewer for Windows 7 flickering issues so that it indicates this problem on versions 4.0.0.0 and prior, the flicker issue is fixed as of this version. Added NLINE-E devices and indicated that references to ENET devices apply to NLINE-E devices. Added ENET, USB-MA4 and NLINE-E devices to Trademark declaration.
11/5/20	L5	<ul style="list-style-type: none"> Update section on 1553 Signal Viewer based on changes made to the “Test Signal” tab.
3/23/21	L6	<ul style="list-style-type: none"> Added A429 Signal Viewer option information for Show Empty Data Made note of the Ctrl-K and <Esc> shortcuts on the ENET Config Dialog for the OK and Cancel buttons respectively. Updated BC Control Panel images and added text concerning the C Code Generation button.
8/20/21	L7	<ul style="list-style-type: none"> Added NLINE-EA429, NLINE-UA429 and MEZ-E1553 device support. Added information for Cut/Copy/Paste on the BC Control Panel, Basic BC Message List. Added information on using the C Code Generation for BC Aperiodic message and on the RT Control Panel.
3/18/22	L8	<ul style="list-style-type: none"> Added information for the Cut/Copy/Paste on the BC Control Panel, Aperiodic Message List. Added information for the Cut/Copy/Paster on the RT Control Panel.

		<ul style="list-style-type: none"> • Updated Splash screen information. • Removed Appendix E, corrected note tags and removed EBR columns as all EBRs have full analyzer capability.
11/21/22	L9	<ul style="list-style-type: none"> • Updated main screen to reflect updated format • Added Convert Device information to Logo Button Menu • Added information for the Cut/Copy/Paste on the A429 TX Control Panel • Added information and images for the BC Retry button on the BC Control Panel. • Updated various dialogs to with new Stopped/Running and Archiving images.
6/22/2023	M1	<ul style="list-style-type: none"> • Changed Global Control IRIG Calibration to show the Voltage instead of raw numbers • Added usage of the BM 1553 Graphical Viewer • Added usage of the Link/Spec mode for EBR
11/21/2023	M2	<ul style="list-style-type: none"> • Added Run # Times to the BC Control Panel • Added the Running Icon to the 1553 Data Table Dialog • Added Message Colors dialog usage setting in the CDP Graphical Viewer • Added the Data parameters information to the CDP Graphical Viewer • Added User Names Color field • Added User Names CSV Save • Added information on the default binary display of A429 labels in the EU Data column of the A429 Data Table • Updated NAICS # and added UEID #
7/1/2024	M3	<ul style="list-style-type: none"> • Added Histogram Dialog Instructions • Added the new Convert “From CSV” option under the File Viewer entry